



<i>Title:</i> NEON Preventive Maintenance Procedure: AIS Surface Water Quality Multisonde		<i>Date:</i> 04/19/2022
<i>NEON Doc. #:</i> NEON.DOC.001569	<i>Author:</i> B. Nance, D. Monahan, M. Mahal, M. Cavileer	<i>Revision:</i> D

NEON PREVENTIVE MAINTENANCE PROCEDURE: AIS SURFACE WATER QUALITY MULTISONDE

PREPARED BY	ORGANIZATION	DATE
Jesse Vance	AQU	06/05/2017
Michele Mahal	CVAL	05/22/2019
Dylan Monahan	AQU	05/22/2019
Bryce Nance	AQU	10/11/2021
Madeline Cavileer	ENG	10/11/2021

APPROVALS	ORGANIZATION	APPROVAL DATE
Kate Thibault	SCI	04/19/2022

RELEASED BY	ORGANIZATION	RELEASE DATE
Tanisha Waters	CM	04/19/2022

See configuration management system for approval history.



Title: NEON Preventive Maintenance Procedure: AIS Surface Water Quality Multisonde		Date: 04/19/2022
NEON Doc. #: NEON.DOC.001569	Author: B. Nance, D. Monahan, M. Mahal, M. Cavileer	Revision: D

Change Record

REVISION	DATE	ECO #	DESCRIPTION OF CHANGE
A	07/20/2017	ECO-04064	Initial release AIS Sensor Maintenance Procedure
B	08/27/2019	ECO-06161	Reformatted and reorganized information to align with NEON configuration management template and current AIS maintenance documents. Added additional maintenance details on existing procedures/ requirements. Added new procedures for maintenance on connectors, infrastructures, anti-fouling equipment and central wiper. Incorporated new or updated graphics to clarify instructional guidance. Reduced biweekly calibrations to every 4 weeks. Provided additional information and clarifications on cleaning, calibrations, removal, replacement, shipping, handling, storage and packaging. Incorporated the use of the Black Guard in calibrations of optical sensors. Incorporated new guidance from CVAL on fDOM and Chla calibration solutions for Field Science. Updated Calibration file transfer process from the field to CVAL using the IS Control and Monitoring Suite. Incorporate Maximo configuration explanation. Added how to do a factory reset for calibrations procedure. Established pass/fail criteria for calibrations.
C	12/01/2021	ECO-06706	Updated new calibration frequency requirements. Removed wording related to chlorophyll sensors at stream sites. Added working related to multiple chlorophyll streams at lake sites. Updated all graphics to match new KOR software. Updated graphics related to calibration pass/fail criteria. Included extra appendix to discuss wiper issues.
D	04/19/2022	ECO-06814	<ul style="list-style-type: none"> • Minor formatting updates



Title: NEON Preventive Maintenance Procedure: AIS Surface Water Quality Multisonde		Date: 04/19/2022
NEON Doc. #: NEON.DOC.001569	Author: B. Nance, D. Monahan, M. Mahal, M. Cavileer	Revision: D

TABLE OF CONTENTS

1 DESCRIPTION..... 1

1.1 Purpose..... 1

1.2 Scope 1

2 RELATED DOCUMENTS AND ACRONYMS..... 2

2.1 Applicable Documents 2

2.2 Reference Documents 2

2.3 External References..... 3

2.4 Acronyms 4

3 SAFETY AND TRAINING 6

3.1 Safety..... 6

3.2 Training Requirements..... 6

3.2.1 Domain Laboratory Safety Training..... 6

3.2.2 Electrical Safety Training..... 7

4 SENSOR OVERVIEW 8

4.1 Description 8

4.2 Handling Precautions..... 9

4.2.1 Sensor Handling Precautions 9

4.2.2 Subsystem Handling Precautions.....11

4.3 Operation11

5 PREVENTIVE MAINTENANCE.....16

5.1 Equipment16

5.2 Subsystem Location and Access.....17

5.2.1 Wadeable Stream Sites17

5.2.2 Lake and River Sites.....20

5.3 Maintenance Procedure.....22

5.3.1 Preventative Maintenance Procedure Sequence Overview.....23

5.3.1.1 Daily24

5.3.1.2 Bi-weekly.....24

5.3.1.3 Monthly (Every 4 Weeks)25



Title: NEON Preventive Maintenance Procedure: AIS Surface Water Quality Multisonde		Date: 04/19/2022
NEON Doc. #: NEON.DOC.001569	Author: B. Nance, D. Monahan, M. Mahal, M. Cavileer	Revision: D

- 5.3.1.4 Bi-Monthly (Every 8 weeks).....25
- 5.3.1.5 Quarterly (Every 3 Months).....25
- 5.3.1.6 Annually25
- 5.3.1.7 Seasonal Variances/As-Needed Basis26
- 5.3.2 Remote Monitoring.....26
- 5.3.3 Visual Inspections26
- 5.3.4 Anti-Fouling Equipment Maintenance.....27
- 5.3.5 Central Wiper Maintenance.....29
- 5.3.6 Wetmatable Connector & Port Maintenance.....30
- 5.3.7 Battery Maintenance.....34
 - 5.3.7.1 Battery Compartment O-Ring Maintenance.....35
 - 5.3.7.2 Internal Battery Voltage Check36
- 5.3.8 Connect to the Multisonde37
- 5.3.9 Collect Pre-Clean and Post-Clean Reading.....45
- 5.3.10 Biweekly Probe Sensor Cleaning Procedures48
 - 5.3.10.1 Turbidity, Chlorophyll, and fDOM Optical Sensor Probes49
 - 5.3.10.2 Dissolved Oxygen (DO) Optical Sensor Probe49
 - 5.3.10.3 pH/ORP Sensor Probes.....50
 - 5.3.10.4 Conductivity & Temperature Sensor Probe.....51
- 5.4 Field Calibration Procedure52
 - 5.4.1 Domain Lab Preparation52
 - 5.4.1.1 Calibration Solution Lot Numbers.....52
 - 5.4.1.2 Calibration Solution Requirements55
 - 5.4.1.3 Deionized (DI) Water Requirements63
 - 5.4.2 Field Calibration Procedures63
 - 5.4.2.1 Calibration Solutions: Field Equilibration Procedure64
 - 5.4.2.2 Field Calibration and Validations Procedures65
 - 5.4.2.3 Field Calibration Procedure: Conductivity.....71
 - 5.4.2.4 Field Calibration Procedure: Turbidity.....73
 - 5.4.2.5 Field Calibration Procedure: Chlorophyll (TAL-PC) (Buoy Only).....76
 - 5.4.2.6 Field Calibration Procedure: Fluorescent Dissolved Organic Matter (fDOM).....79



Title: NEON Preventive Maintenance Procedure: AIS Surface Water Quality Multisonde		Date: 04/19/2022
NEON Doc. #: NEON.DOC.001569	Author: B. Nance, D. Monahan, M. Mahal, M. Cavileer	Revision: D

- 5.4.2.7 Field Calibration Procedure: pH.....81
- 5.4.2.8 Field Calibration Procedure: Dissolved Oxygen (DO).....83
- 5.4.2.9 Field Calibration Procedure: Depth Sensor (Buoy Sites Only)86
- 5.4.2.10 Pass/Fail Calibration Criteria87
- 5.5 Saving Calibration Files91
- 5.6 Seasonal Maintenance (Stream Sites).....91
- 6 REMOVAL AND REPLACEMENT (SUBSYSTEM ONLY).....95**
- 6.1 Equipment95
- 6.2 Removal and Replacement Procedure.....95
 - 6.2.1 Stream Sites (S1 and S2).....96
 - 6.2.1.1 Removal Procedure.....96
 - 6.2.1.2 Replacement Procedure98
 - 6.2.2 Lake and River Sites (Buoy) 101
 - 6.2.3 Central Wiper Brush Removal & Replacement..... 101
- 6.3 Cleaning & Packaging of Returned Sensor..... 102
 - 6.3.1 Decontamination Requirements..... 102
 - 6.3.2 Long- and Short-Term Probe Sensor Storage Requirements..... 103
 - 6.3.3 Packaging Requirements 104
 - 6.3.3.1 Probe Sensor Shipping Requirements 105
 - 6.3.3.2 Probe Sensor Packaging Guidance..... 106
 - 6.3.4 Shipping 107
- 6.4 Sensor Refresh Record Management of Assets..... 108
 - 6.4.1 NEON Asset Management and Logistic Tracking System Requirements 108
 - 6.4.2 Remote Connection Program Information Requirements..... 108
- 7 ISSUE REPORTING OUTPUTS 110**
- 8 FIELD CALIBRATION DATA TRANSMISSION INSTRUCTIONS 112**
- 9 MULTISONDE CONFIGURATION IN MAXIMO 119**
- 10 WIPER MAINTENANCE AND CALIBRATION..... 123**
- 10.1 Quarterly/Annual maintenance..... 123
- 10.2 Calibration 123
- 10.3 Troubleshooting 123



Title: NEON Preventive Maintenance Procedure: AIS Surface Water Quality Multisonde		Date: 04/19/2022
NEON Doc. #: NEON.DOC.001569	Author: B. Nance, D. Monahan, M. Mahal, M. Cavileer	Revision: D

LIST OF TABLES AND FIGURES

Table 1. Multisonde Parameters: Probe Sensors, Central Wiper and Multisonde Body12

Table 2. Preventative Maintenance Equipment16

Table 3. Multisonde Preventative Maintenance Tasks Interval Schedule22

Table 4. Components Requiring Visual Inspections.....27

Table 5. Sensor Anti-Fouling Equipment Maintenance.....27

Table 6. Multisonde Wetmatable Connector Maintenance.....31

Table 7. Internal Battery Voltage Check.....36

Table 9. How to Directly Connect to the Multisonde using USB.....38

Table 10. How to Connect to a Multisonde using Bluetooth42

Table 11. How to Collect Pre-Clean and Post-Clean Readings/Values45

Table 12. Solution Preparation Equipment.....55

Table 13. Calibration Solution Requirements and Creation Instructions.....55

Table 14. Calibration Solution Preparation: fDOM Sensor59

Table 15. Calibration Solution Preparation: Total Algae/Chlorophyll Sensor61

Table 16. Ambient Air and Stream Temperature Equilibrium Guidance64

Table 17. Field Calibration/Validation Procedure66

Table 18. Seasonal Maintenance: Stream Flow Changes92

Table 19. Equipment for Sensor and Subsystem Removal and Replacement95

Table 20. Multisonde Removal Procedures for Stream Sites96

Table 21. Multisonde Replacement Procedures for Stream Sites99

Table 22. Probe Sensor Storage Requirements 103

Table 23. Probe Sensor Shipping Requirements..... 105

Table 24. How to Unpack a Sensor Probe 106

Table 25. Multisonde Issue Reporting Datasheet 110

Table 26. Multisonde Data Stream Configuration..... 120

Figure 1. YSI EXO2 Multisonde 10

Figure 2. Example of a Plugged Port (Far Left) and Examples of the DO (Middle) and the pH Probe Caps (Far Right)..... 10

Figure 3. Sensor Port Configuration for EXO2 Multisonde 12

Figure 4. Conductivity & Temperature Probe Sensor 12

Figure 5. Turbidity Probe Sensor 13

Figure 6. Optical Dissolved Oxygen (DO) Probe Sensor..... 13

Figure 7. pH & ORP Probe Sensor 13

Figure 8. Total Algae (Chlorophyll) Probe Sensor 14

Figure 9. fDOM Probe Sensor..... 14

Figure 10. Central Wiper (Not a Sensor) 14

Figure 11. Instrument for Probe Sensors 15



Title: NEON Preventive Maintenance Procedure: AIS Surface Water Quality Multisonde		Date: 04/19/2022
NEON Doc. #: NEON.DOC.001569	Author: B. Nance, D. Monahan, M. Mahal, M. Cavileer	Revision: D

Figure 12. Multisonde on an Anchor with Subsystem Components at Wadeable Stream Location.....18

Figure 13. Domain 11, Southern Plains, BLUE Single Stream Sensor Set from Downrigger Mounting off Bridge.....19

Figure 14. Stream Stand-Alone Arbors (left, middle) and Device Post Arbor (far right).....19

Figure 15. AIS Buoy for Lake and River Sites20

Figure 16. At select sites, the Multisonde measures a Vertical Profile from the Center of the Buoy from a Winch20

Figure 17. Domain 03, Flint River (FLNT) Buoy contains Two Multisondes.....21

Figure 18. Aquatic Portal Precip DIN Rail: AIS Buoy Portal Radio/Oz Grape Subsystem21

Figure 19. Flip Circuit Breakers Down to Turn off Power (This Combo Box is Live - Power is ON)23

Figure 20. Disable the Buoy from its Power Source: Disconnect the "Pwr In" Cable on the Profile Canister (Source: AD [10])24

Figure 21. Location of Antifouling Guard27

Figure 22. Use a Cloth to Remove Minimal Biofouling.....28

Figure 23. Soak to Remove Heavier Biofouling.....28

Figure 24. Scrub to Remove Heavy Biofouling29

Figure 25. Multisonde Anti-Fouling Wiper: Levels of Wear over Time29

Figure 26. Use a Rubber Band to Control the Brush from Significant Splaying due to Turbulent Waterways30

Figure 27. Apply Krytox to Female 6-Pin Connectors31

Figure 28. Greased Female 6-Pin Connector with Krytox.....31

Figure 29. Male 6-Pin Connector and Dummy Plug for 6-Pin Connectors.....32

Figure 30. Sensor 4-Pin Connectors on Multisonde Body (Left) and Probe Sensor (Right).....32

Figure 31. Multisonde Probe Tool and Krytox GPL 205 Lubricant Use.....33

Figure 32. Sensor Locking Nuts & Retaining Ring.....33

Figure 33. Depth Ports on EXO2 Multisonde33

Figure 34. Depth Port Quarterly Maintenance.....34

Figure 35. How to Replace Multisonde Internal D-Cell Batteries.....35

Figure 36. Lubricate Battery Cap with Krytox Grease35

Figure 37. Remove Damaged O-Rings and Replace with Lightly Greased New O-Rings.....36

Figure 38. Battery voltage can be found under Live Data37

Figure 39. Battery Orientation on Battery Cap.....37

Figure 40. Merlot Grape with Signal Output Adapter (Splitter/Converter Box)38

Figure 41. Disconnect the Black Power Cable39

Figure 42. Bring the Multisonde up from Vertical Profiling39

Figure 43. Connect to Multisonde using a USB SOA.....40

Figure 44. Insert Small End of USB Cable into SOA Connector40

Figure 45. Align the Connector's Six Pins and Jackets with Sensor40

Figure 46. Complete Connection to Multisonde using a USB SOA41

Figure 47. Multisonde will automatically appear here.....41



Title: NEON Preventive Maintenance Procedure: AIS Surface Water Quality Multisonde		Date: 04/19/2022
NEON Doc. #: NEON.DOC.001569	Author: B. Nance, D. Monahan, M. Mahal, M. Cavileer	Revision: D

Figure 48. Wake up the Multisonde!42

Figure 49. Activate the Multisonde's Bluetooth Capability [Source: ER [02]]42

Figure 50. Open “Devices and Printers” Window and Select "Add a device"43

Figure 51. Add YSI Device.....43

Figure 52. Enter Passcode to Access Device43

Figure 53. Successful Connection using Bluetooth.....44

Figure 54. Scan for Bluetooth Devices from main dashboard.....44

Figure 55. Example/Location of Bluetooth Blue LED45

Figure 56. Antifouling Guard on Multisonde.....46

Figure 57. Example of Kor dashboard.....46

Figure 58. Pre-Cleaning and Post-Cleaning Examples.....47

Figure 59. Capture Post-Clean Reading using Same Bucket of Water.....47

Figure 60. Submit Pre-clean/Post-clean Results in Fulcrum.....47

Figure 61. View "Live Data" for bucket check data48

Figure 62. Clean Optical Sensor Windows49

Figure 63. Example of Biofouling on Sensor Probes49

Figure 64. Clean DO Probe Sensor50

Figure 65. Clean pH/ORP Sensor Probe50

Figure 66. Example of Biofouling on Sensor Probes51

Figure 67. Clean Conductivity & Temperature Sensor Probe.....52

Figure 68. YSI C/T Sensor Cleaning Brush SKU: 59947052

Figure 69. Lot Numbers on Multisonde Calibration Solutions.....53

Figure 70. Solution Lot Numbers for Rhodamine and Quinine Sulfate54

Figure 71. Multisonde Fulcrum Applications58

Figure 72. Solution Dilution File Name for Multisonde Cleaning and Calibration [PROD] Fulcrum Application58

Figure 73. fDOM Calibration Solution Set-up59

Figure 74. Graduated Pipette Use for fDOM Calibration Solution60

Figure 75. Prepared fDOM Calibration Solution with Amber/HDPE Bottles61

Figure 76. Total Algae/Chlorophyll Calibration Solution Preparation.....61

Figure 77. Dilute 5 mL of Stock Solution into 1000 mL Flask and Bring to Volume with DI Water.....62

Figure 78. Prepare Total Algae/Chlorophyll Calibration Solution with Rhodamine WT and DI Water62

Figure 79. DI Water Minimum Requirements: ATSM Type II63

Figure 80. Alternate Setups for pH and DI Water Temperature Equilibration.....65

Figure 81. Remove Central Wiper Brush.....66

Figure 82. Triple Rinse Sensors & Calibration Cup with DI Water (Source: ER [08] Slide 10)67

Figure 83. Multisonde Black Plastic Guard for Calibration of Optical Sensors.....68

Figure 84. Amount of Calibration Solution to Use for each Sensor Probe68

Figure 85. Connect to the Multisonde69

Figure 86. Navigate to calibration menu.....69



Title: NEON Preventive Maintenance Procedure: AIS Surface Water Quality Multisonde		Date: 04/19/2022
NEON Doc. #: NEON.DOC.001569	Author: B. Nance, D. Monahan, M. Mahal, M. Cavileer	Revision: D

Figure 87. Select parameters for calibration.....70

Figure 88. Bryce Nance is Gently Rotating the Multisonde to Remove Bubbles.....71

Figure 89. Input data in editable fields.72

Figure 90. Wait for stable data before applying.72

Figure 91. Successful calibration summary page.73

Figure 92. Pour Solution at an Angle to Decrease Aeration.....73

Figure 93. First calibration point.....74

Figure 94. Continue adding calibration points.....74

Figure 95. "Complete Calibration" once appropriate number of points complete.....75

Figure 96. Calibration Solution Application in Fulcrum76

Figure 97. Kor v2 has two values to calibrate.....76

Figure 98. Enter values in software.....77

Figure 99. Complete first calibration point and then proceed to second.77

Figure 100. Enter values for first calibration point.....79

Figure 101. Proceed to second calibration point.79

Figure 102. pH Probe Calibration Buffer Solutions.....81

Figure 103. pH Buffer Solutions in Stream.....81

Figure 104. Fill the Calibration Cup with Buffer Solution to 1st Line.....82

Figure 105. First calibration point.82

Figure 106. From this menu, select "Add Another Cal Point" to proceed to the second and third values.83

Figure 107. Fill Bottom of Calibration Cup with DI Water for DO Probe84

Figure 108. Select ODO % Sat.....84

Figure 109. Enter values for first calibration point.....85

Figure 110. Complete the single point calibration.86

Figure 111. Depth calibration point.....87

Figure 112. S1/S2 Clean comparison criteria.87

Figure 113. Calibration Pass/Fail criteria for sites with two (2) multisondes.88

Figure 114. Calibration Pass/Fail criteria for sites with one (1) multisonde.89

Figure 130. QC Score Key: Pass/Fail Calibration Criteria90

Figure 116. Green bar indicates a successful calibration.....90

Figure 117. Red bar indicates a failed calibration.90

Figure 118. At the end of every PM, collect calibration into one CSV.....91

Figure 131. Multisonde Calibration Manual Override92

Figure 120. Dry Stream Bed (D14 SYCA).....92

Figure 121. Winter Season Ice Accumulation (D18 OKSR).....93

Figure 122. NEON.D07.LECO.DP1.20002 High Flow Events93

Figure 123. Seasonal Hazards.....94

Figure 124. D03 FLNT River Buoy Drawing with Standpipe94

Figure 125. AIS Combination Box - 5 Amp Breakers.....96

Figure 126. Disconnect Ethernet Cable (RJF) from Merlot Grape97



Title: NEON Preventive Maintenance Procedure: AIS Surface Water Quality Multisonde		Date: 04/19/2022
NEON Doc. #: NEON.DOC.001569	Author: B. Nance, D. Monahan, M. Mahal, M. Cavileer	Revision: D

Figure 127. Remove Cotter Pin to Remove PVC Slip Cap.....97

Figure 128. Disconnect Sensor Power Cable.....97

Figure 129. Use the Multisonde Probe Tool to Remove each Sensor Probe from the Multisonde98

Figure 130. Multisonde Merlot Grape in Grape Shield with Converter/Splitter Box98

Figure 131. How to Reinstall a Sensor Probe99

Figure 132. Reinstall the Multisonde Grape99

Figure 133. Connect Sensor Cables to Grape 100

Figure 134. Multisonde Cable Dressing - Complete Installation..... 100

Figure 135. Rock Brush to ensure Fit against the D Shaft..... 101

Figure 136. Multisonde Probe Sensor Asset Tags 102

Figure 137. General Probe Sensor Packaging for Shipping/Handling 105

Figure 138. DO Sensor Probe Shipping Requirements..... 105

Figure 139. pH Probe Shipping Requirements..... 106

Figure 140. Sensor Packaging/Cardboard Box..... 106

Figure 141. Remove the Sensor from the Box and Expand the Sides of the Cardboard Insert..... 107

Figure 142. Move the Sides of the Insert up to Create Slack in Plastic Packaging to Remove Sensor and Asset Tag..... 107

Figure 143. Red Rejected Tag for Defective Assets (MX104219) 111

Figure 144. Select the Run Icon in the Upper Left Hand Corner..... 112

Figure 162. Close-up of Run Icon 112

Figure 146. Navigate to the Utilities Tab and Select "AIS file upload to CVAL" 112

Figure 147. Select Sonde only to upload Multisonde Calibration Data Pop-up Window..... 113

Figure 148. Input Operator Name..... 113

Figure 149. Select the Site of the Calibration Pop-up Window 114

Figure 150. Input Date of Multisonde Calibration..... 114

Figure 151. Select Multi-Site or Single Site 115

Figure 152. For the First Site, Select the Files for the Site You Identified in Step 5 115

Figure 153. After Completing the Process for the First Site, Select the Remaining Files for the Second Site You Identified in Step 5..... 116

Figure 154. Upload Most Recent Calibration Files to CVAL 116

Figure 155. Archival of Kor Calibration Files on C Drive 117

Figure 156. Click the "X" to Exit the Application..... 117

Figure 157. How a Sensor Streams with a Single EPROM ID 119

Figure 158. How a Multisonde Streams with Multiple EPROM IDs 120

Figure 159. When calibrating wiper, click left/right to adjust. 123

Figure 160. Diagram of wiper data assessment. 124



Title: NEON Preventive Maintenance Procedure: AIS Surface Water Quality Multisonde		Date: 04/19/2022
NEON Doc. #: NEON.DOC.001569	Author: B. Nance, D. Monahan, M. Mahal, M. Cavileer	Revision: D

1 DESCRIPTION

1.1 Purpose

Routine preventive maintenance is imperative to ensure the proper functional and operational capability of National Ecological Observatory Network (NEON) systems, and the preservation of NEON infrastructure. This document establishes mandatory procedures and recommended practices for preventive maintenance of the **EXO2 Multiparameter Sonde**, herein referred to as the **Multisonde or Sonde**, to meet the objectives of the NEON Program, and its respective stakeholders and end users.

1.2 Scope

Preventive Maintenance is the planned maintenance of infrastructure and equipment with the goal of improving equipment life by preventing excess depreciation and impairment. This maintenance includes, but is not limited to, inspecting, adjusting, cleaning, clearing, lubricating, repairing, and replacing, as appropriate. The procedures in this document are strictly preventive and do **not** address corrective actions.

This document addresses preventive maintenance procedures to maintain the Multisonde (**HB07532000, HB07531000, HB07530020, and HB07530030 Subsystems**) at Aquatic Instrument System (AIS) sites. This includes preventive maintenance procedures and requirements for the instrument and subsystem. Preventive maintenance for supporting infrastructures are in AD [04] and AD [05].



Title: NEON Preventive Maintenance Procedure: AIS Surface Water Quality Multisonde		Date: 04/19/2022
NEON Doc. #: NEON.DOC.001569	Author: B. Nance, D. Monahan, M. Mahal, M. Cavileer	Revision: D

2 RELATED DOCUMENTS AND ACRONYMS

2.1 Applicable Documents

The following applicable documents (AD) contain mandatory requirements and/or supplementary information that are directly applicable to the topic and/or procedures herein. Visit the [NEON Document Warehouse](#) for electronic copies of these documents.

AD [01]	NEON.DOC.004300	EHSS Policy and Program Manual
AD [02]	NEON.DOC.004316	Operations Field Safety and Security Plan
AD [03]	NEON.DOC.050005	Field Operations Job Instruction Training Plan
AD [04]	NEON.DOC.004613	NEON Preventive Maintenance Procedure: AIS Buoy
AD [05]	NEON.DOC.003880	NEON Preventive Maintenance Procedure: AIS Stream Infrastructure
AD [06]	NEON.DOC.004886	NEON Preventive Maintenance Procedure: Aquatic Portal & AIS Device Posts
AD [07]	NEON.DOC.001166	NEON Sensor Command, Control and Configuration (C3) Document: Multisonde, Stream
AD [08]	NEON.DOC.003808	NEON Sensor Command, Control and Configuration (C3) Document: Buoy Meteorological Station and Submerged Sensor Assembly
AD [09]	NEON.DOC.005048	Neon Installation Procedure: HB066000XX- Subsystem, Sensor Infrastructure, Stream, [Sand, Bedrock, Cobble]
AD [10]	NEON.DOC.001972	AIS Comm Interconnect Mapping
AD [11]	NEON.DOC.002716	NEON Preventive Maintenance Procedure: Submersible Ultraviolet Nitrate Analyzer (SUNA)
AD [12]	NEON.DOC.005039	Multisonde Wiper Maintenance

2.2 Reference Documents

Reference documents (RD) contain information complementing, explaining, detailing, or otherwise supporting the information included in the current document.

RD [01]	NEON.DOC.000008	NEON Acronym List
RD [02]	NEON.DOC.000243	NEON Glossary of Terms
RD [03]	NEON.DOC.004257	NEON Standard Operating Procedure (SOP): Decontamination of Sensors, Field Equipment and Field Vehicles
RD [04]	NEON.DOC.004638	AIS Verification Checklist
RD [05]	NEON.DOC.002767	AIS Subsystem Architecture, Site Configuration and Subsystem Demand by Site - SCMB Baseline
RD [06]	NEON.DOC.004608	AIS Buoy Verification Procedures
RD [07]	NEON.DOC.005038	NEON Standard Operating Procedure (SOP): Sensor Refresh
RD [08]	NEON.DOC.004638	AIS Verification Checklist
RD [09]	NEON.DOC.000769	Electrostatic Discharge Prevention Procedure
RD [10]	NEON.DOC.004472	PDS Array Device Post and Field Device Post Formal Verification Procedures
RD [11]	NEON.DOC.004651	Domain 18 (D18) AIS Oksrukuyik Creek (OKSR) Alternate Power Site Standard Operating Procedure (SOP)



Title: NEON Preventive Maintenance Procedure: AIS Surface Water Quality Multisonde		Date: 04/19/2022
NEON Doc. #: NEON.DOC.001569	Author: B. Nance, D. Monahan, M. Mahal, M. Cavileer	Revision: D

RD [12]	NEON.DOC.004822	Domain 14 (D14) AIS Sycamore Creek (SYCA) Alternate Power Site Standard Operating Procedure (SOP)
RD [15]	NEON.DOC.001215	L1F000 Sonde Calibration Fixture Manual
RD [16]	HB07532000	Assembly, Multisonde with Sensors, FDOM, Lake, 0-100, KorExo 2.0
RD [17]	HB07530030	Assembly, Multisonde with Sensors, No FDOM, No Total Algae
RD [18]	HB07530020	Assembly, Multisonde with Sensors, FDOM, No Total Algae
RD [19]	NEON.DOC.005233	EXO2 Multisonde Data Management Procedure (Logging Mode)

2.3 External References

The external references (ER) listed below may contain supplementary information relevant to maintaining specific commercial products for the Multisonde probe sensors and subsystems.

ER [01]	USGS TM 1-D3, Guidelines and SOP for Continuous Water-Quality Monitors
ER [02]	YSI Incorporated, EXO user manual, www.EXOwater.com, accessed February 2019 https://www.y.si.com/File%20Library/Documents/Manuals/EXO-User-Manual-Web.pdf
ER [01]	YSI, Incorporated. Vertical Profiler System (CR1000), Version 3. 19 December 2011. https://www.y.si.com/systems
ER [02]	YSI, Inc. Field Survival Guide Checklist for Environmental Sondes. https://www.y.si.com/File%20Library/Documents/Guides/Field-Survival-Guide.pdf
ER [03]	YSI, Inc. Care, Maintenance, and Storage of YSI 6-Series Probes and Sondes. https://www.y.si.com/File%20Library/Documents/Technical%20Notes/T601-Care-Maintenance-and-Storage-of-YSI-6-Series-Probes-and-Sondes.pdf
ER [04]	YSI, EXO User Manual Advanced Water Quality Monitoring Platform, Revision G. https://www.y.si.com/File%20Library/Documents/Manuals/EXO-User-Manual-Web.pdf
ER [05]	Quinine Sulfate, Lab Grade Safety Data Sheet per 29CFR1910/1200 and GHS Rev. 3. Effective date: 10.24.2014: https://beta-static.fishersci.com/content/dam/fishersci/en_US/documents/programs/education/regulatory-documents/sds/chemicals/chemicals-g/S25510A.pdf
ER [06]	Sulfuric Acid, 3M Safety Data Sheet per 29CFR1910/1200 and GHS Rev. 3. Effective date: 02.15.2015: https://beta-static.fishersci.com/content/dam/fishersci/en_US/documents/programs/education/regulatory-documents/sds/chemicals/chemicals-s/S25899.pdf
ER [07]	YSI, Incorporated, <i>How to take care of your new EXO Sonde</i> , YSI Repair Center, Apr 09, 2018 https://www.y.si.com/y.si-blog/water-blogged-blog/2018/04/how-to-take-care-of-your-new-exo-sonde
ER [08]	Xylem Inc. (YSI), <i>Five Costly Mistakes with Water Quality Sondes Webinar Deck</i> , Dec 12, 2014 https://www.slideshare.net/YSIInc/five-costly-mistakes-with-water-quality-sondes-1214-webinar
ER [09]	Rhodamine WT, Safety Data Sheet, 01/09/2011 https://www.aquaread.com/aquaread-content/downloads/msds/Rhodamine-WT-Liquid.pdf
ER [10]	Turbidity Standard, 0, 100 or 800 NTU, YSI Safety Data Sheets, 2014 https://www.y.si.com/File%20Library/Documents/MSDS%20and%20SDS/SDS-US-YSI-6080-Turbidity-Standard-0-NTU.pdf https://www.y.si.com/File%20Library/Documents/MSDS%20and%20SDS/SDS-US-YSI-6073G-Turbidity-Standard-100-NTU.pdf https://www.y.si.com/File%20Library/Documents/MSDS%20and%20SDS/SDS-US-YSI-6074-Turbidity-Standard-800-NTU.pdf
ER [11]	Buffer Solution pH 4.00, YSI Safety Data Sheet According to the (US) Hazard Communication Standard (29 CFR 1910.1200), Revision Date: 12/10/2014 https://www.y.si.com/File%20Library/Documents/MSDS%20and%20SDS/SDS-YSI-3821-Buffer-Solution-pH4.pdf



ER [12]	Buffer Solution pH 7.00, YSI Safety Data Sheet According to the (US) Hazard Communication Standard (29 CFR 1910.1200), Revision Date: 12/10/2014 https://www.ysi.com/File%20Library/Documents/MSDS%20and%20SDS/SDS-YSI-3822-Buffer-Solution-pH7.pdf
ER [13]	Buffer Solution pH 10.00, YSI Safety Data Sheet According to the (US) Hazard Communication Standard (29 CFR 1910.1200), Revision Date: 12/10/2014 https://www.ysi.com/File%20Library/Documents/MSDS%20and%20SDS/SDS-YSI-3823-Buffer-Solution-pH10.pdf

2.4 Acronyms

Acronym	Explanation
A/R	As Required
AIS	Aquatic Instrumentation System
BLUE	Blue River
C/T	Conductivity and Temperature Probe
Cal	Calibration
Chla	Chlorophyll a (for Total Algae sensor)
CFGLOC	Configured Location
Combo	Combination Box (Power and Data)
CVAL	Calibration, Validation and Audit Laboratory
DAS	Data Acquisition System
DI	Deionized
DMM	Digital Multi-Meter
DO	Dissolved Oxygen
DOM	Dissolved Organic Matter
DQ	Data Quality
DSF	Domain Support Facility
EHSS	Environmental, Health, Safety and Security
ESD	Electrostatic Discharge
Eth-To Comm	Ethernet to Communication Box
fDOM	Fluorescent Dissolved Organic Matter
FLNT	Flint River
FNU	Formazin Nephelometric Units
H ₂ SO ₄	Sulfuric Acid
HDPE	High-Density Polyethylene
IR	Infrared
L	Liter
LC	Location Controller
LOTO	Lock-out/Tag-out
MET	Meteorological
MFG	Manufacturer



mL	Milliliter
mg/L	Milligram Per Liter
mS/cm	milliSiemens per cm
NTU	Nephelometric Turbidity Units
ORP	Oxidizing-Reducing Potential
PAR	Photosynthetically Active Radiation
PC	Phycocyanin
PDS	Power Distribution System
PFD	Personal Floatation Device
PoE	Power over Ethernet
PPB	Parts Per Billion
PPE	Personal Protective Equipment
Precip	Precipitation
PRT	Platinum Resistance Thermometer
PVC	Polyvinyl Chloride
QSU	Quinine Sulfate Units
RAW	Raw Sensor Signal
RFU	Relative Florescent Units
S1	AIS Sensor Set 1 (upstream sensor set)
S2	AIS Sensor Set 2 (downstream sensor set)
SDS	Safety Data Sheet
SOA	Signal Output Adapter
SOH	State of Health
SSH	Secure Shell
SSL	Sample Support Library (a Field Science SharePoint Page)
SUNA	Submersible Underwater Nutrient Analyzer
TC	To Contain
TD	To Dispense
TSS	Total Suspended Solids
µg/L	Micrograms Per Liter
UV	Ultraviolet
V	Volts



Title: NEON Preventive Maintenance Procedure: AIS Surface Water Quality Multisonde		Date: 04/19/2022
NEON Doc. #: NEON.DOC.001569	Author: B. Nance, D. Monahan, M. Mahal, M. Cavileer	Revision: D

3 SAFETY AND TRAINING

3.1 Safety and Training

3.2 Safety

Personnel working at a NEON site must be compliant with safe fieldwork practices in AD [01] and AD [02]. The Field Operations Manager and the Lead Field Technician have primary authority to stop work activities based on unsafe field conditions; however, all employees have the responsibility and right to stop work in unsafe conditions.

Technicians must complete safety training and procedure-specific training to ensure the safe implementation of this protocol per AD [03]. Refer to the site-specific EHSS plan via the NEON Program’s Safety document portal for electronic copies.

Preventive maintenance may require the use of a special equipment to access the sensor and/or subsystem assemblies. Follow Domain site-specific [EHS plans via the Network Drive](#) and NEON safety training procedures when conducting maintenance activities. Conduct a safety analysis prior to accessing the sensor subsystems onsite. Reference the [Safety Office SharePoint portal](#) for templates and additional hazard identification information.

Personal Protective Equipment (PPE) may be required in the decontamination procedures to maintain safe working conditions (e.g., use of equipment such as power washers, air compressors, and disinfectants). For this reason, personnel should be trained and familiar with the Safety Data Sheets (SDS) for the cleaning solutions, tools and equipment necessary for decontamination of the sensor sets herein.

Technicians must not enter the water without water safety training and a personal floatation device (PFD), and must display basic competency in boat operation, regardless of whether or not boat operation is a primary responsibility.

3.3 Training Requirements

3.3.1 Domain Laboratory Safety Training

Follow the Domain’s Chemical Hygiene Plan and Biosafety Manual when working with calibration solutions. When mixing calibration solutions, always work under a fume hood, and always wear PPE appropriate to the task. The fDOM sensor calibration solution is quinine sulfate in diluted sulfuric acid; these solutions may cause skin, eye and possible respiratory irritation. Sulfuric acid is corrosive to metals. Exposure damages the copper-alloy components on the sensor within minutes. Remove these components when conducting calibrations with these solutions. Wear the appropriate personal protective equipment (PPE), such as nitrile gloves and eye protection when dispensing acid.



<i>Title:</i> NEON Preventive Maintenance Procedure: AIS Surface Water Quality Multisonde		<i>Date:</i> 04/19/2022
<i>NEON Doc. #:</i> NEON.DOC.001569	<i>Author:</i> B. Nance, D. Monahan, M. Mahal, M. Cavileer	<i>Revision:</i> D

See ER [05], ER [06], and ER [09] - ER [13] in Section 2 to review SDS information for the Multisonde calibration solutions. Dispose of all liquid reagents after each use following local regulations/laws stipulated in the Domain’s Chemical Hygiene Plan and Biosafety Manual. Do not reuse any solution for future calibrations or checks. When using the calibration solutions in the field, dispense solutions over a bucket or catchment area to prevent contaminating the surrounding environment.

3.3.2 Electrical Safety Training

This procedure requires Technicians to work around systems with 240 Volts. Therefore, this procedure requires Authorized Instrument System (IS) Technician to perform powering down/up the system from the power box circuit breakers, and Field Operation Manager approval. The sensor and sensor Grape are below 50V and do not require this certification to perform field cleaning and calibration procedures.



4 SENSOR OVERVIEW

4.1 Description

The NEON Program uses the Multisonde (**Figure 1**) to measure water quality at our wadeable stream sites and via a vertical profiling system (also known as a profiling Multisonde or Sonde) at our lake and river buoy sites. The Multisonde is a multi-parameter sensor platform containing six (6) probe sensors to measure water chemistry. The Multisonde has a probe sensor to measure each of the following parameters: conductivity /temperature, dissolved oxygen (DO), optical turbidity, total algae (herein referred to as the Chlorophyll probe sensor because the NEON program uses the sensor to collect this measurement at lake and river sites), pH (acidity), and fluorescent dissolved organic matter (fDOM). There is an additional port for a central wiper and antifouling copper-alloy components to prevent biofouling.

Biofouling affects the quality of the measurement collection. The sensor's wiper and copper-alloy anti-fouling components only reduce the effects of biofouling; therefore, it is imperative Field Science personnel clean the sensor at biweekly intervals, paying special attention to sites that accumulate biofouling at a quicker rate.

Wadeable Stream Sites (AD [05])

At wadeable stream sites, the Multisonde is housed in a polyvinyl chloride (PVC) enclosure mounted onto a stainless steel anchoring infrastructure. The enclosure has slots to provide adequate flushing of stream water while securing the Multisonde at the appropriate orientation in the stream. The enclosure also provides protection from debris impact, and shields the Platinum Resistance Thermometer (PRT) and the Multisonde probes from direct solar insolation. A PVC slip cap covers the top of the enclosure. A retaining bolt and mounting discs secure the Multisonde in the enclosure. The mounting discs (or Delrin sensor-mounting discs) also provides the mounting aperture for the PRT and acts as a spacer between the Multisonde and the PVC enclosure. Other components for this sensor at stream locations are listed below. *Refer to AD [05] and AD [09] for more information on the stream sensor infrastructure.*

- HB07530020 Assembly, Multisonde with Sensors, with fDOM, No Total Algae
- HB07530030 Assembly, Multisonde with Sensors, No fDOM, No Total Algae
- CB14023600 Grape Merlot G4 12V, 2digi 6anlg (data acquisition device) with CF00700000 sun shield Unistrut mount
- HJ0020000 Signal Output Adapter (which resides in the Converter/Splitter box next to the Merlot Grape. Converts RS-232 to SDI-12 for the Sonde data logger)
- HB08820075 Armored Power over Ethernet (PoE) cord, which connects from the SUNA Grape to S1 or S2 Combination (Combo) Box onshore, which connects to the Aquatic Portal. A 75ft. cable is for



Figure 1. YSI EXO2 Multisonde



Title: NEON Preventive Maintenance Procedure: AIS Surface Water Quality Multisonde		Date: 04/19/2022
NEON Doc. #: NEON.DOC.001569	Author: B. Nance, D. Monahan, M. Mahal, M. Cavileer	Revision: D

high water installations where the Grape is nearby onshore (instead of the stream). This provides power/Comms and contains EEPROM

- HB03500XXX Assembly, Aquatic Stream S1/S2 Anchor (from 60” to 120”) using stainless steel Unistrut

Lake and River Buoy Sites ([AD [04]])

At non-wadeable locations, such as our river and lake sites, the Multisonde suspends from a buoy platform via YSI’s Vertical Profile System. At sites in D05 and D18, the Multisonde links to a cable assembly that wraps around a winch controller. The winch assembly lowers the sensor to profile dynamic depth measurements in intervals. Sensor and subsystem (power distribution and data acquisition system) infrastructure assemblies for this sensor at lake and river locations are listed below. *Refer to AD [04] and RD [06] for more information on the lake and river buoy sensor infrastructure.*

- HB07532000 Assembly, Multisonde with Sensors, FDOM, Lake, 0-100m, KorExo 2.0
- HG10470000 Assembly, Kit, Buoy, Winch Controller 006980, Replaceable Units (for vertical profiler)
- HG10480000 Assembly, Kit, Buoy, Winch Assembly 669501, Replaceable Units (for vertical profiler)
 - Campbell Scientific CR1000 Data Logger (DAS)
- HG10510000 Assembly, Kit, Buoy, Antenna Assembly 202004, Replaceable Units (DAS)
- HG10500000 Assembly, Kit, Buoy, Battery Box Assembly 200102, Replaceable Units (PDS)
- HG10490000 Assembly, Kit, Buoy, T-Frame Assembly 200140, Replaceable Units (contains PDS)
- HG10520000 Assembly, Kit, Buoy, Sounder Depth 200104, Replaceable Units (for vertical profiler)

Sensor Accessories

- 0377870000 EXO Link Adapter 2.0 (connects Multisonde to Buoy data logger/winch system)
- 0320170007 Central wiper for YSI EXO Sonde only
- 0320170008 Anti fouling guard for YSI EXO2 Sonde. Made of a copper alloy.
- 0337890000 EXO2 Calibration/Storage Cup
- Black Plastic Guard

4.2 Handling Precautions

Aquatic Technicians must employ special care to avoid dropping solutions, hardware, or tools into the water while working to prevent contaminating an aquatic environment. In addition, per NEON.AIS.4.1735, all vehicles, trailers, boats, tools, protective outerwear, and any other items that encounter an aquatic or riparian environment, require decontamination prior to site access per RD [03].

4.2.1 Sensor Handling Precautions

When handling the Multisonde probe sensors, **do NOT touch the ends of the sensors**, as many are optical sensors. When in storage or in transport, the pH and Dissolved Oxygen (DO) sensors have specific packaging requirements. The DO probe must have a cap on with a moist sponge touching the probe. Use



DI water for the DO probe. For the pH probe, nothing should touch the sensing area; it must suspend above the solution in the cap (see **Figure 2**). Use the pH 4 Buffer Solution for the pH probe. Invert both probes to check for leaks before placing them in shipping materials. When transporting the sensor probes already attached to the Multisonde to and from the site, attach the calibration cup with a little water inside to keep the sensors moist. Always install plugs (0377880000 YSI EXO 4-Pin Bulkhead Connector Port Plug) in any unused ports on the Multisonde when a probe sensor does not occupy them, especially when the sensor is in the field. This prevents water from damaging the internal electronics of the Multisonde. **Figure 2** provides an example of a plugged port on the Multisonde and an example of the DO and pH probe with caps. Field Science may use alternative caps if they saturate the probe and do not subject the probe to any damage.



Figure 2. Example of a Plugged Port (Far Left) and Examples of the DO (Middle) and the pH Probe Caps (Far Right)

Scratches on the lenses of the Turbidity, Chlorophyll, and fDOM probe sensors affect their ability to take accurate measurements. To transport and store these probes, remove them from the Multisonde and store in their shipping cap (to protect against physical damage).

If an AIS site stream is dry for seven (7+) days or longer, remove the pH and DO probe sensors from the instrument and install a dummy plug in each empty port. Store the DO probe sensor with a moist sponge or saturate in a container with DI water. Store the pH probe in a container with pH 4 buffer solution. If the DO probe sensor was not saturated in DI water in storage, it must be rehydrated for 24 hours in DI water before calibration and reinstallation.

***Note:** If the wiper is active, wait until it completes its rotation and returns to the parked position to conduct preventive maintenance. This should take less than a minute to complete. If the wiper is already in the parked position, proceed with preventive maintenance.*



Title: NEON Preventive Maintenance Procedure: AIS Surface Water Quality Multisonde		Date: 04/19/2022
NEON Doc. #: NEON.DOC.001569	Author: B. Nance, D. Monahan, M. Mahal, M. Cavileer	Revision: D

4.2.2 Subsystem Handling Precautions

Grapes and PoE devices contain electrostatic discharge sensitive parts (see RD [03]); therefore, all Grapes require ESD (antistatic) packaging and handling during inter- and intra-site transport, reception and storage. As a rule, when handling (installing, removing, and servicing) these components, Technicians must ground themselves. Do not hot swap sensor connections! When power is ON, disconnect the RJF/Eth-To Comm Box cable BEFORE disconnecting a sensor cable. Connect a sensor cable BEFORE connecting the RJF/Eth-To Comm Box cable.

4.3 Operation

At wadeable stream sites, the Multisonde is present at both S1 and S2 to measure the changes in water chemistry over the intervening reach to provide data for modeling stream metabolism and general water chemistry. To ensure the Multisonde samples from an area are representative of an entire water column, the sensors must be set at 50% ($\pm 20\%$) water depth in either the thalweg (deepest part of the active channel) or another well-mixed location. Travel time between Multisondes must be no less than 30 minutes and no greater than 60 minutes during normal stream flows. In addition, the Multisonde at downstream/single site locations are set at the same level as the SUNA; the sensor is within 40 cm of the SUNA nitrate measurements, and within 3 cm of the same depth to properly associate the data from each sensor set. The Multisonde samples approximately every minute (0.0167 Hz).

AIS Buoys are present at seven lake sites and three large river sites. Three out of 10 buoys (D05/D18) have a Multisonde that attaches to a winch system to measure the vertical profile of a lake or river in up to 10 increments, divided by the max depth of the lake or river every 4 hours (if the water level is low, it will profile less increments). Within each increment, the Multisonde samples every 5 minutes.

Multisonde Probe Sensors

The Multisonde uses smart technology that allows the instrument to recognize the type (parameter) of sensor plugged into a given port. While the Multisonde is designed to recognize and accurately record any sensor regardless of port number it is installed in, the NEON Program requires that sensors be installed in the same port across the observatory (**Figure 3**). This maintains consistency across sites to identify site-wide probe issues and/or consistent troubleshooting advice that is applicable observatory-wide.

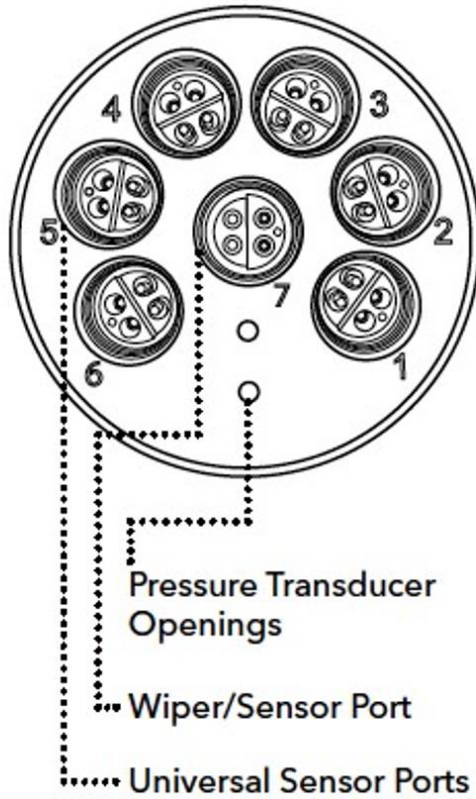

Port No.	Sensor Parameter
1	Conductivity/Temperature
2	Optical Dissolved Oxygen
3	pH
4	Total Algae
5	Turbidity
6	fDOM
7	No Sensor (optical wiper)

Figure 3. Sensor Port Configuration for EXO2 Multisonde

Each probe has a wet-mateable connector, which allow for swaps in wet conditions, while the smart ports shut down any excessive current draws to prevent damage. The operating temperature for each probe is -5 to 50°C. The storage temperature for each probe is -20 to 80°C. **Table 1** is an overview of each probe, to include the central wiper and instrument body where the probes connect.

Table 1. Multisonde Parameters: Probe Sensors, Central Wiper and Multisonde Body



Figure 4. Conductivity & Temperature Probe Sensor

Figure 4 is the [EXO Conductivity & Temperature Smart SKU599870](#). Conductivity is the measure of waters ability to carry an electrical current. The EXO conductivity probe uses four internal, pure-nickel electrodes to measure solution conductance. Two of the electrodes are current driven, and two measure the voltage drop. An algorithm converts the voltage drop into a conductance value in milliSiemens (millimhos). The EXO temperature probe produces data by using a stable and aged thermistor. The thermistor's resistance changes with temperature. An algorithm converts the measured resistance into temperature data.



Figure 5. Turbidity Probe Sensor

Figure 5 is the [EXO Turbidity Smart Sensor SKU599101-01](#). Turbidity is an indirect measurement of the suspended total solid concentration in the water including the amount of clay, silt, inorganic and/or organic matter, algae, and/or other microscopic organisms in the water. It is typically determined by shining a near infrared (IR) light beam (860 nm) into a sample solution and then measuring the right angle scattering of the incident light beam. This sensor reports values in Formazin Nephelometric units (FNU).



Figure 6. Optical Dissolved Oxygen (DO) Probe Sensor

Figure 6 is the [EXO Optical Dissolved Oxygen Smart Sensor SKU599100-01](#). DO is a measurement of the concentration of dissolved oxygen present in a volume of water. This sensor operates by shining a blue light of the proper wavelength on a luminescent dye contained within a polystyrene layer within the sensor cap. DO from the water column diffuses through a permeable layer of protective paint and quenches the luminescence of the dye. Thus, the magnitude of luminescence is inversely proportional to the amount of DO present. The sensor measures for DO in % saturation, DO % local, mg/L units. ***Always store DO sensors in a moist or wet environment in order to prevent sensor drift. However, DO sensors left in dry air for longer than eight hours require rehydration.***



Figure 7. pH & ORP Probe Sensor

Figure 7 is the [EXO pH & ORP Smart Sensor SKU599706](#). pH is a measurement of acidity. The sensor uses a pair of electrodes to measure the differential between a reference solution (pH 7) within a glass bulb, and the outside of the bulb exposed to the environment. The differential between the reference solution (pH 7) and sample creates the sensor measurement. Sampling for pH informs the user on surrounding aquatic bedrock/soils, the influence of carbon dioxide, and potential input of anthropogenic pollutants like acid rain, or mine drainage. Low pH can have a devastating effect on aquatic life. The sensor generates raw data in pH units / ORP millivolts.



Figure 8. Total Algae (Chlorophyll) Probe Sensor

Figure 8 is the [EXO Total Algae PC Smart Sensor SKU599102-01](#). This probe sensor is commonly referred to as Chlorophyll and for sites using older probes, this sensor may be labeled “Chlorophyll-BGA-PC”. The EXO total algae sensor generates a total biomass estimate of the planktonic autotrophic community by measuring both chlorophyll *a* and phycocyanin (PC). Chlorophyll *a* is the green pigment within algal cells, and has an excitation wavelength of 470 nm. Phycocyanin is an additional pigment found in cyanobacteria (blue-green algae) and has an excitation wavelength of 590 nm. It measures emission of both species at a wavelength of 685 nm. Chlorophyll *a* measurements are a means of tracking algae growth. This data may provide information to understand aquatic levels of primary production, potential algae blooms, and possible high levels of nitrogen and phosphorus in waterbodies. The sensor reports both Chla and PC in raw fluorescence units (RFU) and an estimate of the pigment concentration in µg/L.



Figure 9. fDOM Probe Sensor

Figure 9 is the [EXO fDOM Optical Smart Sensor SKU599104-01](#). The EXO fDOM sensor detects the fluorescent component of dissolved organic matter (DOM). It measures using fluorescence, with excitation or emission wavelengths of 365 and 480 nm, respectively. The sensor reports fDOM as quinine sulfate units (QSUs), where 1 QSU = 1 parts per billion (ppb) quinine sulfate. For stream sites with two sensor sets, this probe resides on the Multisonde at S2 (downstream).



Figure 10. Central Wiper (Not a Sensor)

Figure 10 is the [EXO Central Wiper SKU599090-01](#). The NEON program configures the wiper to rotate and wipe the ends of each probe every 5 minutes to reduce biofouling.

 *Note: If the wiper is active, wait until it completes its rotation and returns to the parked position to conduct preventive maintenance. This should take less than a minute to complete. If the wiper is already in the parked position, proceed with preventive maintenance.*



Figure 11. Instrument for Probe Sensors

The Multisonde body contains a non-vented differential strain gauge transducer, which measures pressure on one side of the transducer exposed to the water, and the other side exposed to a vacuum. For accurate readings, the pressure transducer requires calibration by “zeroing” it in the atmosphere at a known barometric pressure. Because it is not vented, changes in barometric pressure affect the “zero” reading, resulting in a shift of the measurement value unless recalibrated.

Figure 11 is the Instrument with the probe sensors and central wiper. The probes depend on the instrument for power and communications. It requires 4 Alkaline Batteries (D-Cell Batteries), O-rings and connector maintenance (lubrication using Krytox).

One of the greatest values of aquatic instruments is the ability to collect high-temporal and frequency measurements over a long timeframe. Changes in water chemistry, nutrients, energy, and turbidity are often ephemeral, but may have long lasting ecosystem consequences. It is important that aquatic instrument dataset contain minimal gaps due to preventable sensor failures. Even instruments that continue to operate onsite are likely to produce bad data when preventive maintenance bouts do not occur. Conducting preventive maintenance is vital to ensure that instruments are in place to collect quality data, and are functioning correctly. If a problem falls outside of normal preventive maintenance activities, Field Science must execute corrective maintenance procedures immediately. An incident ticket in the NEON Program’s Issue Reporting and Management System must accompany all sensor issues found onsite. An example of preventive maintenance activities leading to corrective maintenance activities is a sensor, such as the Multisonde or SUNA, failing field calibrations.



Title: NEON Preventive Maintenance Procedure: AIS Surface Water Quality Multisonde		Date: 04/19/2022
NEON Doc. #: NEON.DOC.001569	Author: B. Nance, D. Monahan, M. Mahal, M. Cavileer	Revision: D

5 PREVENTIVE MAINTENANCE

5.1 Equipment

Table 2. Preventative Maintenance Equipment

P/N	NEON P/N	Description	Quantity
Tools			
NEON, IT		Laptop with Kor Software (and Drivers, if necessary)	1-2
17394	0317400000	Buoy Serial Cable	1
GENERIC		USB-to-9-Pin Male RS-232 cable (to connect to Buoy Serial Cable)	1
FLUKE-1AC-A1-11	MX102703	Fluke Digital Multi-Meter (DMM) (to measure Voltage)	1
599810	0320170022	EXO Signal Output Adapter – USB (to directly connect to the Multisonde for field calibration)	1
GENERIC		Mini B USB Cable (to connect to EXO Signal Output Adapter)	1
599316	0337890000	EXO2 Calibration/Storage Cup (for field calibration)	1-2
		EXO Black Plastic Guard	
599469	0338050000	EXO Replacement Sensor Tool and Magnet Activation Kit	1
599594	0337930000	EXO Tool Kit: Replacement Parts for Maintaining the EXO Multisonde (two sensor removal/Bluetooth activation tools, one battery cover tool, and one syringe for cleaning the depth port)	1
599470	0337870000	EXO C/T Sensor Cleaning Brush	1
GENERIC		5-Gallon Bucket (for waste/prevent contamination spills, to use as a mini laptop desk/chair onsite, and to Multisonde collect pre- and post- cleaning readings with stream, river or lake water)	1-4
GENERIC		Dry Brush (to clean off animal excrement or biofouling/algae from infrastructure components and anti-fouling guard)	1-2
GENERIC		Small Plastic Scrub Brush or Plastic Scraper – NO METAL! (to clean biofouling from sapphire lenses on optical probe sensors)	1-2
GENERIC		Knee Pads (to work on Buoy floating platform/deck)	1 Pair
GENERIC		11-in-1 (to remove components)	1
GENERIC		Small Flat-Blade Screwdriver (to remove components)	1
GENERIC		1 Liter Glass or Teflon DI water bottle (to store DI water)	1-2
599502-01	0320170020	Sensor - YSI EXO2 Multisonde (body only – no sensors)	1-2 per site
599100-01	0320170003	Sensor - Dissolved Oxygen (Optical) - use with YSI EXO sonde.	1 per sensor
599870-01	0320170001	Sensor - Conductivity/Temperature - YSI EXO sonde	1 per sensor
599101-01	0320170004	Sensor - Turbidity, use with YSI EXO sonde.	1 per sensor
599102-01	0320170005	Sensor - Total Algae, use with YSI EXO sonde.	1 per sensor
599104-01	0320170006	Sensor - fDOM, use with YSI EXO	1 per sensor
599706	0320170015	Sensor - pH/ORP, unguarded, use with YSI EXO2 sonde.	1 per sensor
599564	0320170008	Sensor Accessory - Anti fouling guard for YSI EXO2 sonde. Made of a copper alloy.	1
599090-01	0320170007	Sensor - Central wiper for YSI EXO2 sonde only.	1 per sensor
GENERIC		Wash Bottle: 1 for DI water, 1 for mild P-free Detergent	2
Table 10		Pipetting Equipment to Prepare Solutions – <i>See Table 11 on page 55!</i>	Table 11
Consumable Items			
599352		Krytox 205 Grease (for Multisonde Connectors and O-Ring maintenance)	1
599663		<i>Optional:</i> EXO Multisonde Body Protective Sleeves (protects the Multisonde body against biofouling)	A/R
GENERIC	MX100642	Kimwipes/lint-free tissues (e.g., Opto-wipes) or microfiber cloths	A/R



Title: NEON Preventive Maintenance Procedure: AIS Surface Water Quality Multisonde		Date: 04/19/2022
NEON Doc. #: NEON.DOC.001569	Author: B. Nance, D. Monahan, M. Mahal, M. Cavileer	Revision: D

P/N	NEON P/N	Description	Quantity
GENERIC		Powder-free nitrile gloves	A/R
3824	0320170013	YSI Calibration Solution - pH buffer for YSI EXO, Assorted Case of pH Values (for Multisonde Calibrations – each contains two containers each of pH 4, 7, and 10 calibration buffers.)	3L per Sonde with Black Guard
GENERIC		Mild Biodegradable Detergent with degreaser (to clean guard)	A/R
607300	0320170014	YSI Calibration Solution - Turbidity, for use with YSI EXO sonde 6073G Turbidity Std. 100 NTU (6026), 126 NTU (6136), 1 Gallon, use with YSI EXO sonde.	3L/Sonde
060907	0320170011	YSI Calibration Solution - 3167 Conductivity Standard, 1000 micro-mhos/cm (8 each/pint).	3L/Sonde
CVAL	0370480000	Rhodamine WT, 625 µg/L and 25 µg/L dye solutions	3 L/Sonde
CVAL	0370470000	Quinine sulfate solution, 300 µg/L	1 L
GENERIC		Fresh MilliQ Deionized (DI) water, Gallon (for Multisonde Calibrations)	2-3 Gallon/12L+
GENERIC		Clean Tap Water, Gallon	1
GENERIC		Alkaline D-Cell Batteries or NiMH D-cell Batteries with a minimum rating of 10,000 milliamp hours (Multisonde internal batteries)	4
599673		EXO2 Central Wiper Brush Kit (to replace splayed brushes)	1
599668		EXO Sensor Retaining Nut Kit, Titanium (to replace stripped locking nuts)	A/R
599669		EXO2 Wiper Retaining Nut Kit, Titanium (to replace stripped locking nut)	1
599681	0337940000	EXO2 / EXO3 Replacement O-Ring Kit (for Multisonde Maintenance – inspect these when replacing the internal D-cell batteries)	1
599110	0366790000	EXO Dissolved Oxygen Sensor Cap Replacement Kit (Includes hydrating cap and quick start guide)	A/R
599664		EXO2 Replacement 6-Pin Dummy Plug Kit, Male	A/R
599475		EXO 4-Pin Bulkhead Connector Port Plug	2-3
Resources			
Kor Software and Firmware Version 1.1.8 : N:\Common\CVL\Field_Calibration\EXO2 Software and Firmware			
Campbell Scientific LoggerNet™ Software YSI_VPS_30.4.dld : https://www.campbellsci.com/loggernet Download trial and use serial activation key from physical CD given to Domain by YSI.			
PuTTY: http://www.putty.org/			
Sensor Health: https://den-prodissom-1.ci.neoninternal.org/ (Updates every 24 hours)			
IS Control and Monitoring Suite: N:\Common\CVL\Field_Calibration\Required Directory\Test_Data\Current Executables\IS Control and Monitoring Suit			
DQ Blizzard Application: https://den-prodissom-1.ci.neoninternal.org/blizzard/			
SSL for AIS Sensors and Subsystem Components: https://apps.powerapps.com/play/b649433c-1fca-400f-add6-744b8da45a5e?tenantId=f44d2ab3-9099-4d85-9986-10165a8619f5&source=portal&screenColor=rgba(0%2C%20176%2C%20240%2C%201)			
Document Warehouse: https://neoninc.sharepoint.com/sites/warehouse/Documents/Forms/AllItems.aspx			
Drawing Warehouse: https://neoninc.sharepoint.com/sites/warehouse/Drawings/Forms/AllItems.aspx			

5.2 Subsystem Location and Access

5.2.1 Wadeable Stream Sites

At wadeable stream sites, Multisondes are part of both upstream (S1) and downstream sensor sets (S2) or single station sensor sets. At upstream/S1 locations, the Multisonde (sans fDOM probe) is co-located with a Photosynthetically Active Radiation (PAR) PQS1 sensor, a Platinum Resistance Thermometer (PRT), and a Level TROLL. For downstream/S2 locations, the Multisonde is co-located with the same sensors as S1, but



with an additional sensor probe to measure for fDOM and a SUNA (**Figure 12**). It primarily shares a space with the PRT in a fixed PVC tube, which in many cases mounts from a Unistrut anchor (image to the right in **Figure 12**).

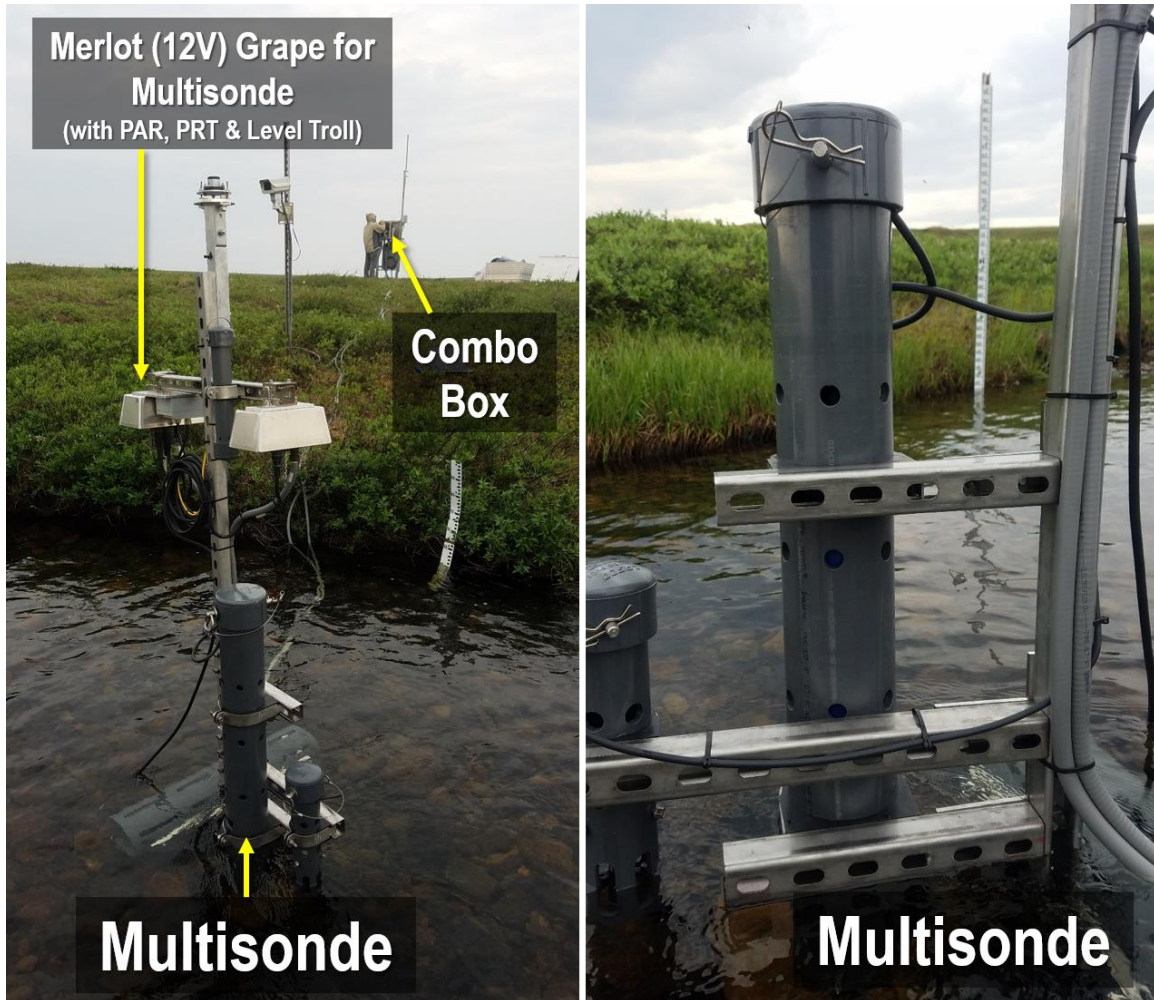

Figure 12. Multisonde on an Anchor with Subsystem Components at Wadeable Stream Location

For our single station sensor set at [Domain 11 Blue River \(BLUE\)](#) AIS stream site, the Multisonde is horizontal with the SUNA. This is due to the volatility of the hydrologic and geomorphologic conditions at BLUE. This stream sensor set suspends from a bridge using a downrigger design (**Figure 13**). As the NEON program evolves/matures, sites may change from a vertical mount to a horizontal mount. The infrastructure components are the same.



Figure 13. Domain 11, Southern Plains, BLUE Single Stream Sensor Set from Downrigger Mounting off Bridge

The sensor subsystems are with the sensors on an anchor or nearby onshore (for BLUE they suspend from the bridge as shown in **Figure 13** above). The Multisonde shares a Merlot (12V) Grape with the Level TROLL, PAR and PRT and connects to a splitter (see **Figure 12** and **Figure 14**). At high-water and overhang sites, the sensor Grape mounts to an arbor on or above the bank onshore as a stand-alone installation or on a device post with a Power and/or Comm/Combo box (**Figure 14**). The Grape supplies power to the Multisonde and transmits its data to the Location Controller (LC) in the Aquatic Portal. Reference AD [05], AD [06] and AD [10] for more information on AIS stream mechanical and electrical infrastructure.



Figure 14. Stream Stand-Alone Arbors (left, middle) and Device Post Arbor (far right)



5.2.2 Lake and River Sites

At river and lake sites, the Multisonde suspends from the AIS Buoy. The AIS Buoy is a floating platform that includes an integrated meteorological (MET) station, an in-situ aquatic sensor set that includes; a fixed underwater measurement set and at some sites a profiling underwater measurement set (**Figure 15**). At lake sites, the buoy anchors in the deepest location of the lake. At river sites, the buoy anchors as close to the rivers thalweg as possible, constrained by either navigation pathways, or the strength of the river's current.



Figure 15. AIS Buoy for Lake and River Sites

The Multisonde measures a vertical profile at CRAM, LIRO, TOOK (**Figure 16**).

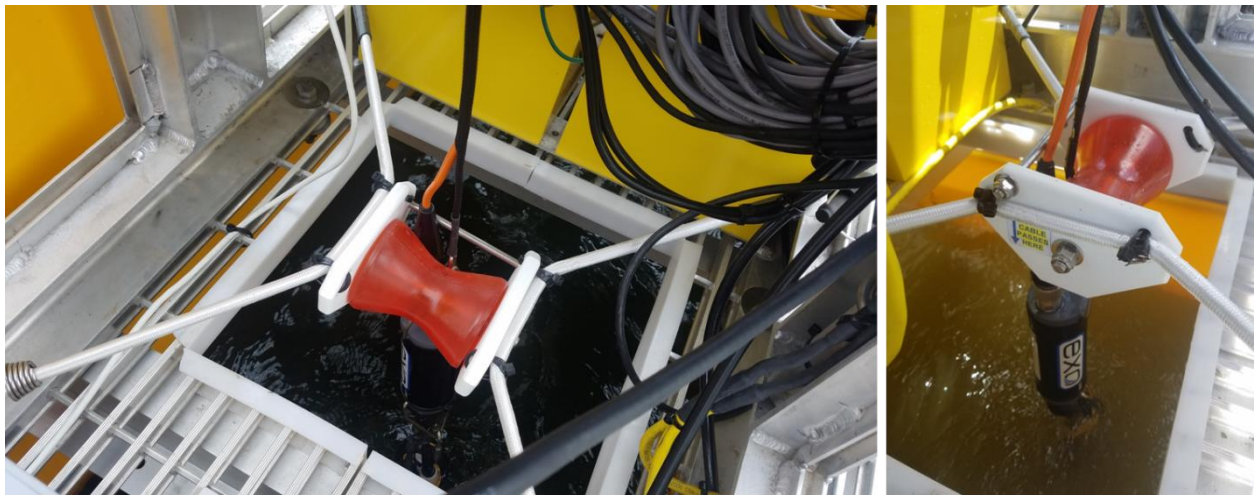

Figure 16. At select sites, the Multisonde measures a Vertical Profile from the Center of the Buoy from a Winch

Reference AD [04] for more information on the AIS Buoy.

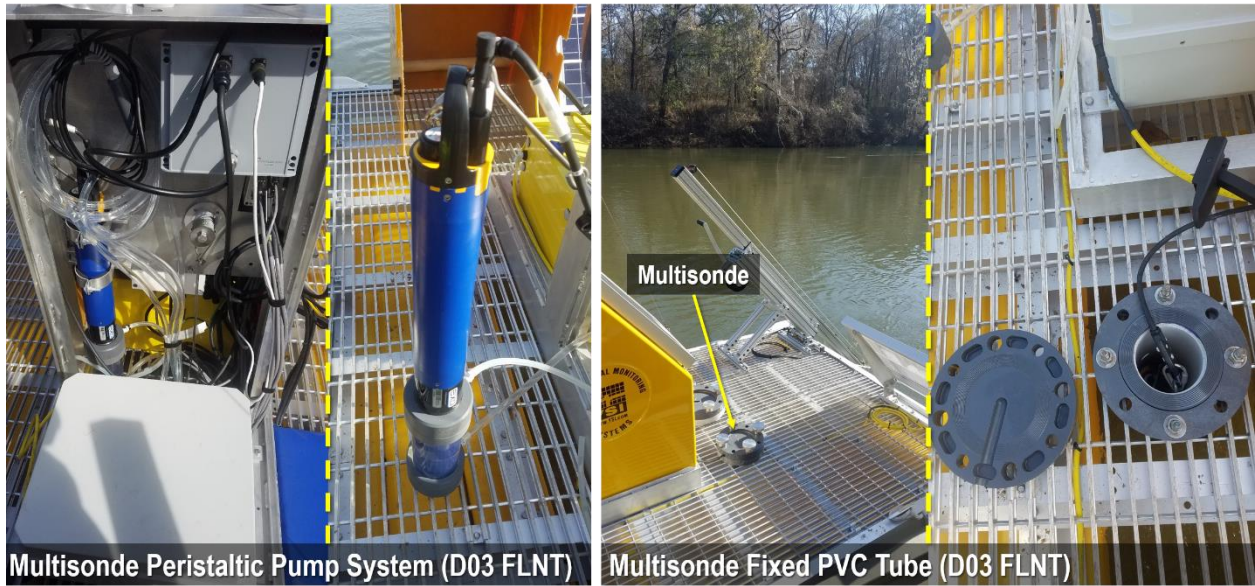



Figure 17. Domain 03, Flint River (FLNT) Buoy contains Two Multisondes

The Multisonde data, along with all onboard sensors (except for the SUNA), transmits via the buoy radio to the Aquatic Portal in bursts. (The SUNA has its own separate radio to transmit data. See AD [11] for more information on the SUNA.) The buoy uses Campbell scientific CR1000 data loggers for the profiler and onboard sensors. It does not use any Grapes onboard. In the Aquatic Portal, the buoy radio transmitter/receiver connects to an Oz grape, which transmit data to the LC and back to HQ.

 Note: The Oz Grape does not require annual calibration and validation (do not remove this Grape for Sensor Refresh).

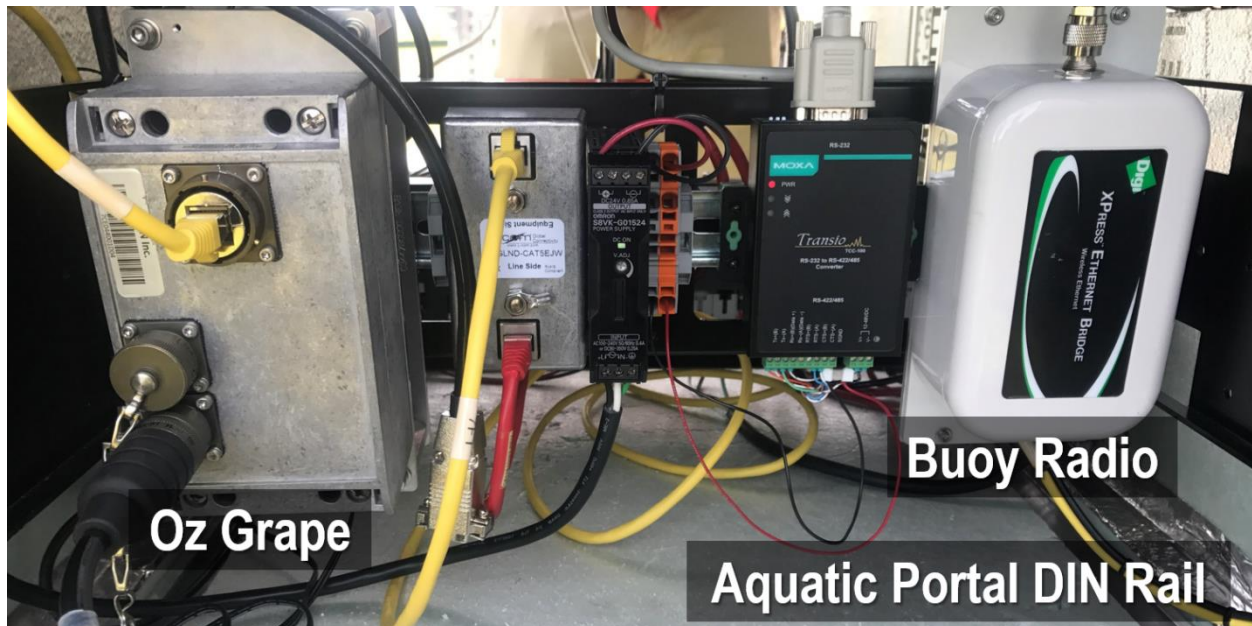

Figure 18. Aquatic Portal Precip DIN Rail: AIS Buoy Portal Radio/Oz Grape Subsystem

Onboard solar panels and batteries power the buoy sensor sets. The SUNA radio box connects directly to the battery box for power. Reference AD [04] and RD [06] for more information on AIS Buoy mechanical and electrical infrastructure.

5.3 Maintenance Procedure

Preventive maintenance activities start with planning and scheduling. Multisonde data carries a bi-monthly calibration record; any variance in the schedule requires an investigation by AIS Science to determine if there is a potential need for a data quality flag. **Table 3** is an interval schedule of each component requiring preventive maintenance.

Table 3. Multisonde Preventative Maintenance Tasks Interval Schedule

Maintenance	Bi-Weekly (Every 2 weeks)	Monthly	Bi-Monthly (Every 8 weeks)	Quarterly	Bi- Annual (Twice yearly)	Annual	As Needed	Maintenance Type
AIS Stream/Lake/River Multisonde								
Remote Monitoring	<i>Verify Data is Streaming Daily!</i>							P
Visual Inspection	X							P
Clean Sensor Probes	X							P
Clean Sensor Body		X		X			X	P
Clean Anti-Fouling Components	X						X	P
Field Calibration			X				X	P
Internal D-Cell Battery Maintenance	X						X	P/R
Central Wiper / Brush Maintenance				x			X	P/R
Central Wiper Test		x					X	P/R
Lubricate Wet-mate Connectors							X	P
Depth Port Maintenance		X						P
Seasonal Maintenance				X		X	X	P/R
Electrical & Communication Infrastructure (DAS and PDS)								
Visual Inspection	X							P
Replace Cable Ties							X	R
Clean Biofouling from Cables / Wires							X	P/R
Physical Infrastructure Components								
Visual Inspection	X						X	P
Remove Debris from Infrastructure	X						X	P



Maintenance	Bi-Weekly (Every 2 weeks)	Monthly	Bi-Monthly (Every 8 weeks)	Quarterly	Bi- Annual (Twice yearly)	Annual	As Needed	Maintenance Type
Clean Algae from Infrastructure	X						X	P
Clear Debris from Pump Tubes (FLNT Only)	X						X	P

P = Preventive, R = Repair, X = Indicates preventive maintenance task time interval may increase due to environmental (seasonal/weather) or unforeseen/unanticipated site factors.

5.3.1 Preventative Maintenance Procedure Sequence Overview

As a rule, power down the sensors when conducting maintenance to prevent HQ, CI from ingesting bad data from the sites. If the sensors undergo maintenance when the power is on, submit a ticket in the NEON Program’s Issue Management and Reporting System to notify AIS Science Staff to flag the data for data quality/control.

For the Multisondes at stream sites, power down the sensors at the combo box. Flip the circuit breakers down in the combo box to de-energize the sensor set at each stream location (**Figure 19**). Red means power is ON and green means power is OFF.

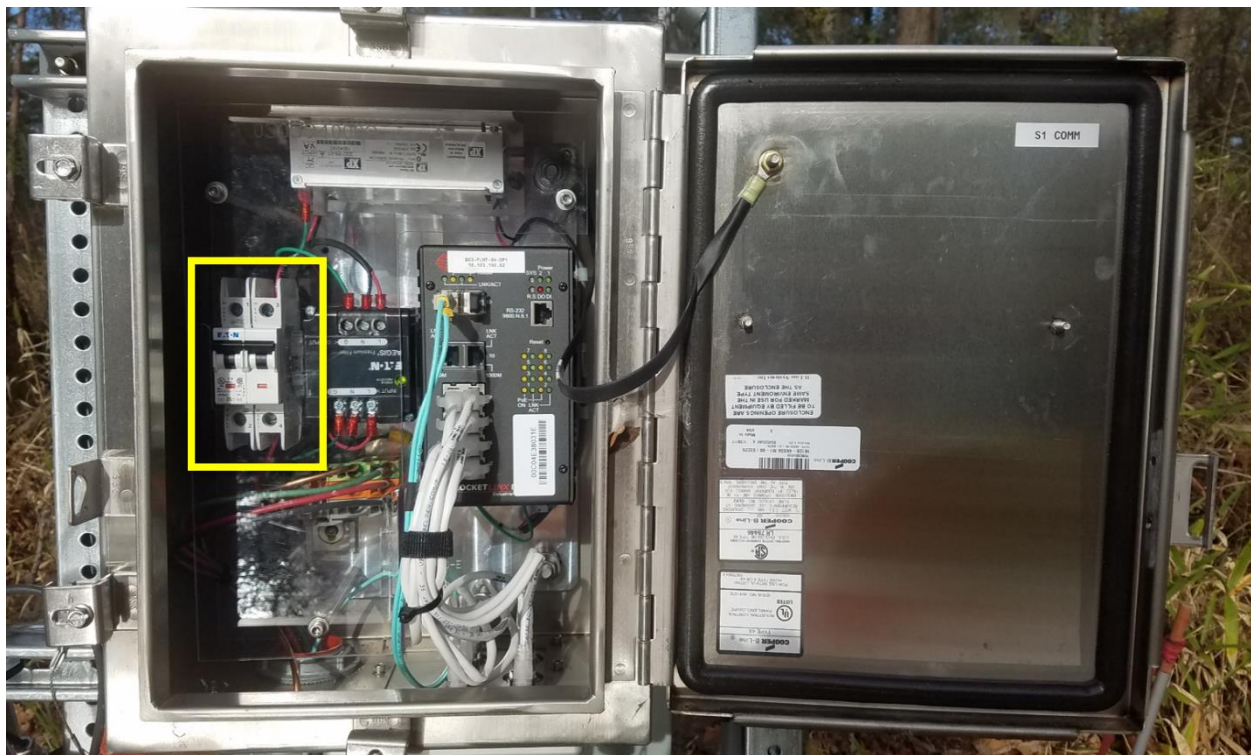

Figure 19. Flip Circuit Breakers Down to Turn off Power (This Combo Box is Live - Power is ON)

For the Multisonde at river/lake locations, power down the buoy sensors on the buoy by disconnecting the cable at the “Pwr In” connector. **Never disconnect the power cable that connects from the Profile**



to the Met Canister. The CR1000 data loggers in the buoy profile/winch and MET canisters continue to collect and store data, even when the power is shutdown at the Aquatic Portal (since the Buoy receives solar/battery power from its own standalone system). When power resumes onsite, data collected during a maintenance visit transmits to the Aquatic Portal and enters our data pipeline. This requires HQ resources to flag the bad data, if HQ science personnel are aware of the bad data entering the pipeline. This is why it is best to stop data collection and storage from the sensors on the buoy all at once before conducting maintenance either on or near sensor measurement areas. **Figure 20** displays where to disconnect the sensor when conducting maintenance activities for both river and lake locations.

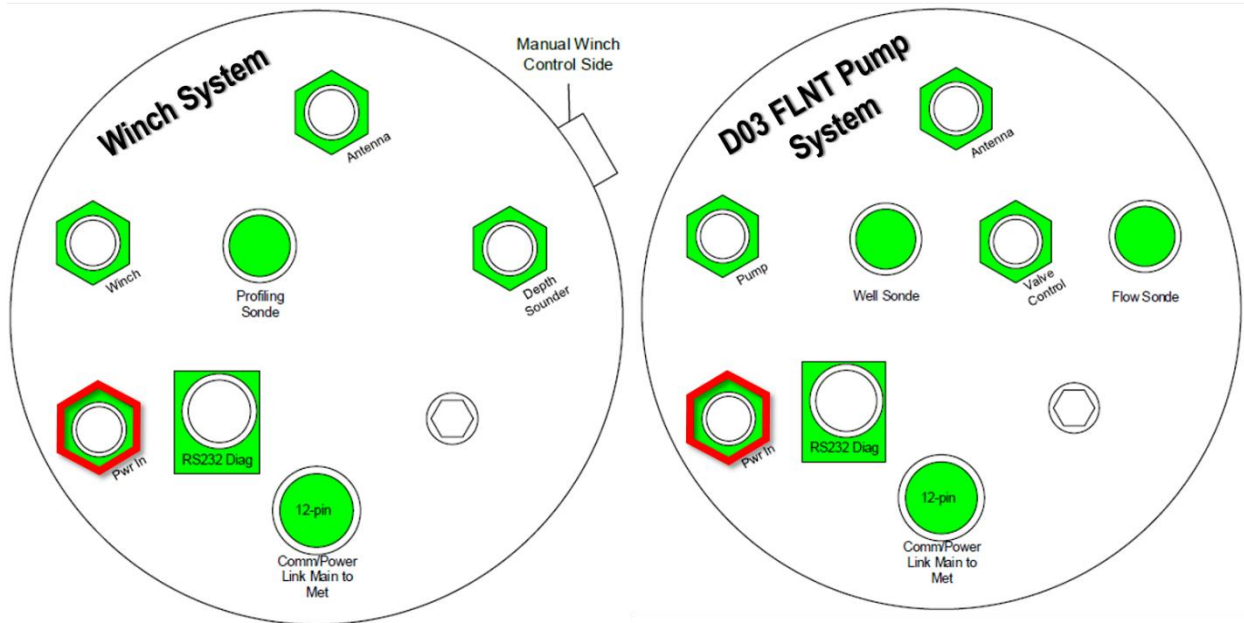

Figure 20. Disable the Buoy from its Power Source: Disconnect the "Pwr In" Cable on the Profile Canister (Source: AD [10])

5.3.1.1 Daily

Remotely monitor Multisonde data streams to verify the sensor is online, operational and data is reaching HQ. Ensure the sensor is reporting values that are normal/expected for the site. Conduct this remote monitoring through a combination of the available tools: Sensor Health Report, IS Monitoring Suite, SSH Clients (e.g., PuTTY), LC State of Health (SOH), Data Quality (DQ) Blizzard, and the Site Sensor Mismatch Report. If the values look outside the normal or expected range for the site, submit an incident ticket with a data quality task for AIS Science to investigate.

5.3.1.2 Bi-weekly

The following is a summary list of bi-weekly maintenance procedures herein.

- Visual Inspections of Sensor, Subsystems, and Infrastructure (Section 5.3.3)
 - Clean algae from infrastructure to prevent contamination of the DO sensor probe.
 - Verify sensor installation aligns with the SUNA, as applicable (downstream and single stream sensor sets)



Title: NEON Preventive Maintenance Procedure: AIS Surface Water Quality Multisonde		Date: 04/19/2022
NEON Doc. #: NEON.DOC.001569	Author: B. Nance, D. Monahan, M. Mahal, M. Cavileer	Revision: D

- Inspect stream flow – see seasonal maintenance in Section 5.6 to address season-specific preventive maintenance.
- Inspect Central Wiper for wear and tear and test its functionality quarterly per Section 5.3.5.
- Clean anti-fouling components per Section 5.3.4.
- Battery and O-ring Maintenance per Section 5.3.7.1.
- Reference AD [05] for preventive maintenance procedures for stream infrastructure.
- Reference AD [04] for preventive maintenance procedures for the AIS Buoy infrastructure.
- Reference AD [06] for general AIS site electrical infrastructure.
- Field Probe Sensor Cleaning Procedures (Section 5.3.10)
 - Prepare and equilibrate solutions for sensor probe calibrations.
 - Collect a pre-clean reading.
 - Clean sensor probes and antifouling guard.
 - Collect a post-clean reading.
- Field Calibration and Validation Procedures (Section 5.4)
 - A sensor that failed clean comparisons on the previous bout must be calibrated.
- Verification of Sensor Configuration/Settings
 - Battery voltage check per Section 5.3.7.2.

5.3.1.3 Monthly (Every 4 Weeks)

Perform specific field calibration and validation procedures every 4 weeks after conducting routine bi-weekly maintenance. Only conduct calibration of the pH probe and any probes that failed the previous cleaning bout comparison. See Section 5.4 for detailed field calibration and validation instructions.

5.3.1.4 Bi-Monthly (Every 8 weeks)

Regardless of clean comparison, all probes must be calibrated on a bi-monthly basis. If a probe was deemed in error and calibrated during any of the previous 3 bi-weekly bouts, the probe still must be calibrated during the main bi-monthly PM bout.

5.3.1.5 Quarterly (Every 3 Months)

Maintain central wiper (Section 10.1).

5.3.1.6 Annually

Conduct Sensor Refresh for the sensor probes. Swap the infield (old) probes with a CVAL calibrated (refreshed/new) probes when this occurs in the field. The Multisonde instrument body and central wiper remain with the site. Reference RD [07] for additional information on Sensor Refresh. Use this event to lubricate the connectors on the Sonde with Krytox grease. See Section 5.3.6 for more information on connector maintenance.



Title: NEON Preventive Maintenance Procedure: AIS Surface Water Quality Multisonde		Date: 04/19/2022
NEON Doc. #: NEON.DOC.001569	Author: B. Nance, D. Monahan, M. Mahal, M. Cavileer	Revision: D

5.3.1.7 Seasonal Variances/As-Needed Basis

- If the water level of the stream drops below the 50% (± 0.20) science requirement (NEON.AIS.4.1770) for the Multisonde water depth, lower the Sonde to re-establish it at 50% (± 0.20) again. For Multisondes on the downstream S2 infrastructure with the SUNA, lower the SUNA to ensure the two sensors match per NEON.AIS.4.1783. Measure pre- and post-sensor positions in the stream for AIS Science Staff to archive with the associated data. (This does not apply to the Level TROLL; do not move the Level TROLL for seasonal variances, only for sensor refresh.)
- If an AIS site stream is dry for seven (7+) days or longer, remove the pH and DO probe sensors from the instrument and plug each port. The remaining sensors may stay with the sensor onsite.
- For sites where the stream completely freezes, such as the AIS sites in Alaska, remove the Multisonde from the site and store at the Domain Support Facility (DSF). Sites that do not freeze down to the substrate continue as normal.

See Section 5.6 for seasonal maintenance for stream sites.

5.3.2 Remote Monitoring

Verify the Multisonde probe sensors are streaming data to HQ daily. Reference **Table 2** in the Resources section for links to the following remote monitoring software applications: Sensor Health, PuTTY, IS Monitoring Suite, DQ Blizzard and LC SOH application. Links to these tools are available in **Table 2**. If the Multisonde data is not streaming data or is streaming irregular values, investigate the issue further and submit an Incident Ticket with a data quality task to inform AIS Science of the issue.

5.3.3 Visual Inspections

The goal of all AIS instrumentation is to measure natural conditions. To that aim, the NEON program’s Preventive Maintenance procedures should cause little to no disturbance to the natural conditions at the site. In general, the implementation of preventive maintenance procedures should not require removal of live rooted vegetation. We do not want to remove any living vegetation surrounding the sensor and infrastructure. However, if living vegetation is growing directly on the infrastructure or entangled in such a way that it prevents the removal and maintenance of the Multisonde, remove as little vegetation as possible to access the sensor and/or its subsystems. Do not remove vegetation that does not directly interfere with the maintenance or safety of the sensor and personnel servicing the sensor with the exception of algae. Clean off algae from sensor infrastructure as it affects the DO sensor probe measurements.

Reference AD [05] for visual inspection of stream infrastructure, AD [04] for visual inspection of the AIS Buoy infrastructure, AD [06] for general AIS site electrical infrastructure. These reference documents include the stream anchors, buoy sensor mounts, Aquatic Portal and device posts, and subsystem components and their supporting infrastructures.



Specific visual inspections for the sensor and its infrastructure include inspecting the following components in **Table 4** for visible damage, tampering, corrosion, degradation and significant bio fouling. Capture pictures of each component displaying damage/issues and report incidents in the NEON Program’s Issue Reporting and Management System.

Table 4. Components Requiring Visual Inspections

STREAM SITES	LAKE/RIVER SITES
Sensor PVC Housing on Stream Anchor (includes cotter pin, stream depth to verify science requirements, and stainless steel Unistrut mounts)	Winch System and Controller area – clear area of any debris caught from lake/river flow D03 FLNT: Fixed PVC Housing under Buoy deck grates and Peristaltic Pump system (specifically clearing debris from the tubes)
Sensor power cable to Merlot Grape 12V Merlot Grape connections and connectors Armored Ethernet cable to Combo box Combo box connections and connectors	Sensor power cable to Profiler Canister Profiler canister connector Power cable to battery box Aquatic Portal Precip DIN Rail (Radio & Oz Grape)

5.3.4 Anti-Fouling Equipment Maintenance

In the Field, the Multisonde uses anti-fouling copper-alloy guard to discourage the growth of aquatic organisms. However, with the NEON program’s long deployment intervals, and with variable site conditions, such as highly productive rivers and streams, biofouling may occur more frequently, regardless of the anti-fouling equipment. Therefore, the sensor anti-fouling equipment requires cleaning once every two weeks to prevent contamination of sensor measurements.

Follow the guidance in **Table 5** to address biofouling buildups on the sensor’s antifouling components. This procedure requires powder-free rubber gloves, cloth/rag, dishwashing liquid soap that contains a degreaser, clean water, small plastic scrub brush or plastic scraper, and a bucket to soak the guard, if necessary. Field Science may wrap the body of the Multisonde in a protective sleeve to reduce the accumulation of biofouling on the sensor body (part number is available in **Table 2** under consumables). Do not use antifouling tape or wraps around any of the probe sensors.

Table 5. Sensor Anti-Fouling Equipment Maintenance



Figure 21. Location of Antifouling Guard

STEP 1 | Remove and inspect the Copper Guard from the Multisonde (**Figure 21**).

Conduct the following options to address varying levels of biofouling that may occur across our Aquatic sites with the information below.

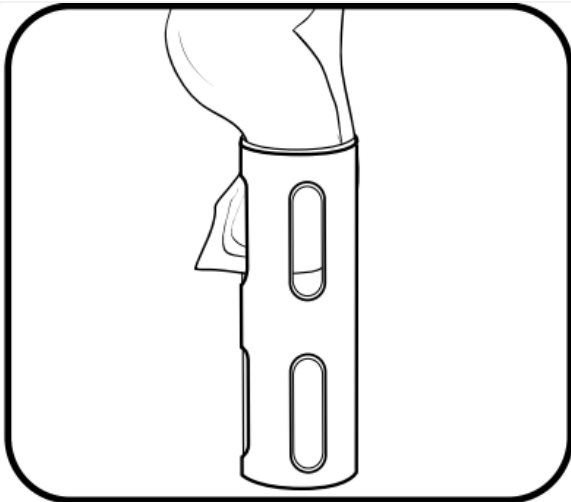

Figure 22. Use a Cloth to Remove Minimal Biofouling

STEP 2 | If the guard contains a thin layer of slime or filaments, wipe away the biofouling with a cloth soaked in clean water and a few drops of a dishwashing liquid that contains a degreaser (**Figure 22**).

Rinse the guard with clean water and inspect.

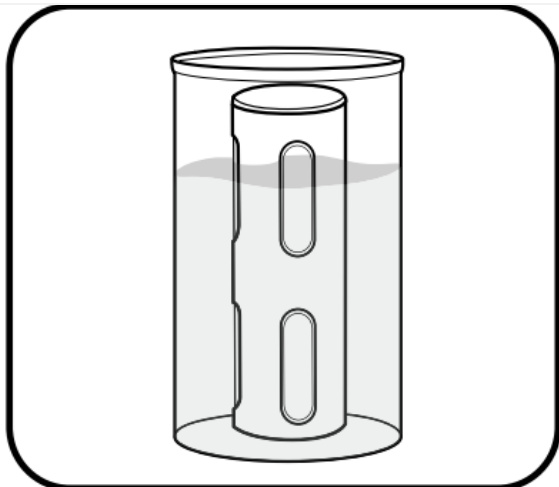

Figure 23. Soak to Remove Heavier Biofouling

STEP 2.1 | If the guard has a thick layer of filaments or barnacles, soak it for 10-15 minutes in a solution of clean water and a few drops of the same dishwashing liquid that contains a degreaser (**Figure 23**).

Following the soak, rinse the guard with clean water and inspect.

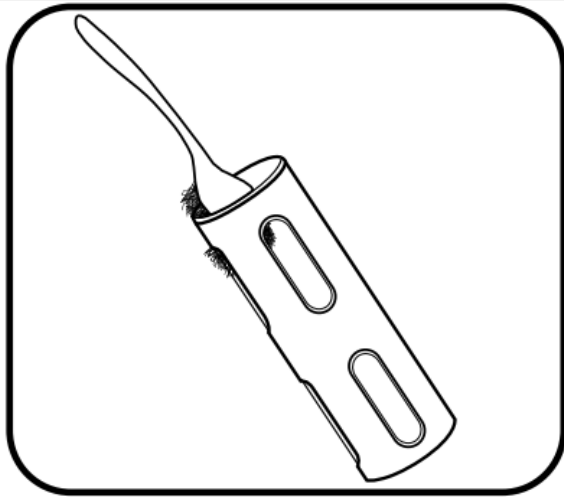

Figure 24. Scrub to Remove Heavy Biofouling

STEP 2.2 | If biofouling remains on the guard, use a small plastic scrub brush or plastic scraper to gently scrub the biofouling off the guard (**Figure 24**).

After scrubbing, wipe the guard with a wet, soapy cloth and rinse.

Field Science may also soak the component in vinegar to remove biofouling accumulations and calcium deposits before scrubbing.

5.3.5 Central Wiper Maintenance

The central wiper is a mechanism to clean sediment off the optical sensing areas of the sensor probes. The wiper swipes every 5 minutes. At this setting, the wiper brush may wear within 2-6 months, depending the volatility of the body of water the Multisonde is located. YSI provides a replacement wiper brush kit (SKU: 599673), which includes one wiper brush, screw and hex wrench. This frequency of wiping also requires quarterly lubrication and annual replacement of o-rings within the wiper.

Inspect the Multisonde wiper for excessive splaying to prevent the wiper from stalling when operational. This is level 3 in **Figure 25** below. If the wiper displays excessive wear characterized by “splaying” of the bristles, request a replacement wiper to replace the wiper during your next site visit. Reference Section 6.2.3 for replacement and removal instructions.



Level 1- New brush, minimal “splay”



Level 2- Moderate splaying, have spare ready



Level 3- Excessive splay, replace to prevent stalling of wiper

Figure 25. Multisonde Anti-Fouling Wiper: Levels of Wear over Time

For locations with turbulent rivers, splaying may occur more frequently. Verify the splayed brush is still wiping the optical window. If the splayed brush cannot wipe the optical window, the brush requires a replacement. Field Science Technicians may use a rubber band to “re-train” the bristles back into their



Title: NEON Preventive Maintenance Procedure: AIS Surface Water Quality Multisonde		Date: 04/19/2022
NEON Doc. #: NEON.DOC.001569	Author: B. Nance, D. Monahan, M. Mahal, M. Cavileer	Revision: D

original shape (Figure 26). This should extend the use of the brush until the next PM bout. ***This method is OK for the Multisonde. Do not use this method on the SUNA.***



Figure 26. Use a Rubber Band to Control the Brush from Significant Splaying due to Turbulent Waterways

Conduct an annual wiper test. Only conduct this test if the wiper is in good condition post-visual inspections. Remove the sensor from its housing or from underwater while remaining connected to its Grape or EXO Link Adapter for power. Wait to observe and time the wiper for two consecutive cycles. Record the cycle timeframes, in addition to the Multisonde removal and test timeframe, to notify AIS Science to flag the data at HQ.

5.3.6 Wetmatable Connector & Port Maintenance

Periodically (as needed) and opportunistically, inspect each port for contamination (grit, hair, etc.). When the port's rubber appears dry, lightly grease the sensor connector before insertion. According to YSI, Wetmatable connector maintenance is frequently the most unnecessary and costly damage to Multisondes that we see in the repair center. It is one of the most expensive items on the Multisonde next to the battery compartment (see Section 5.3.7 for battery maintenance). Ignoring routine maintenance of these connectors may cost up to \$800-\$1,800+ to repair per Multisonde. **Table 6** provides specific maintenance instructions for each connector. The maintenance procedures for this section require Krytox grease, rubber gloves, lint-free cloth (to wipe up any excess grease), and compressed air.

 **Note:** Never insert solid objects into the Multisonde ports. This could permanently damage the connectors. Use only Krytox grease to lubricate the mating surfaces of the connectors.



Table 6. Multisonde Wetmatable Connector Maintenance



Figure 27. Apply Krytox to Female 6-Pin Connectors

Female 6-pin Connectors

These connectors are located on field cables, the EXO2 accessory connector, and the EXO Handheld. Periodically inspect the connectors for signs of contamination. If you detect debris, remove it with a gentle blast of compressed air. Prior to initial installation, or when dry, apply a light coat of Krytox grease to the flat rubber mating surface on top of the connector.

When not in use, always install the connector's plug

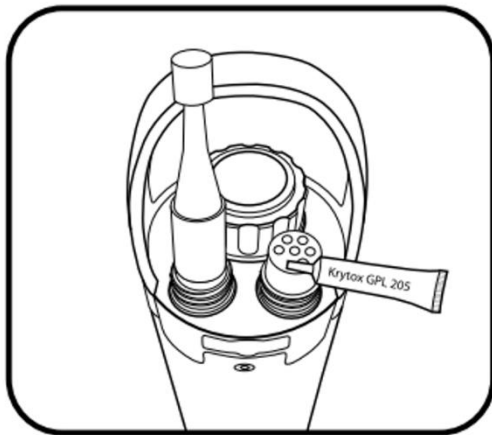
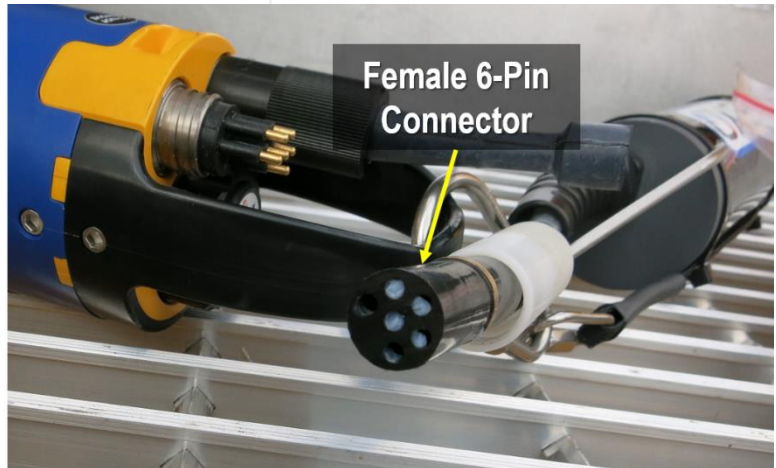

Figure 28. Greased Female 6-Pin Connector with Krytox



Male 6-pin connectors

These connectors are located on field cables and topside Multisonde connectors (**Figure 29**). Periodically inspect the connectors for signs of contamination. If you detect debris, carefully remove it. Prior to initial installation, or when dry, apply a light coat of Krytox grease to the rubber mating surfaces of the connector (including the rubber portions of the pins). When not in use, always install the connector's plug.

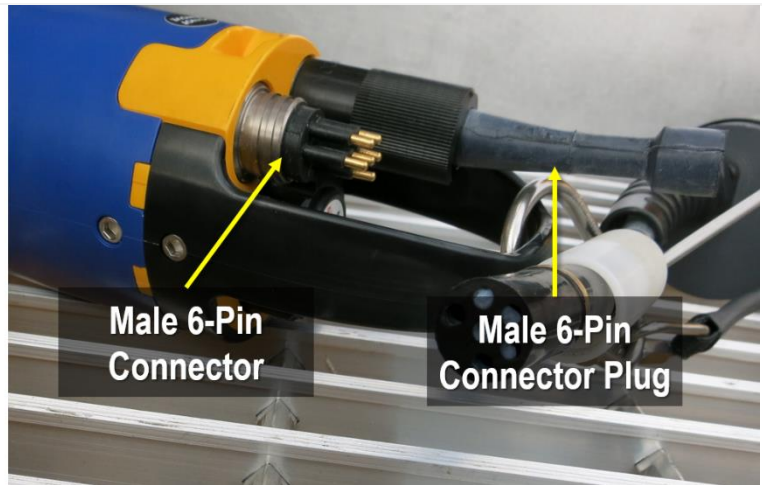
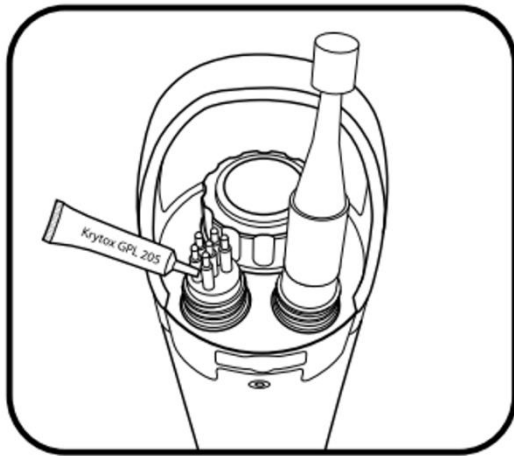

Figure 29. Male 6-Pin Connector and Dummy Plug for 6-Pin Connectors

Sensor connectors (4-pin)

These connectors are located on Multisonde bulkheads (sockets) and sensors in **Figure 30**. Periodically inspect the female portions of these hermaphroditic connectors and the entire socket for contamination, and remove any debris with a gentle blast of compressed air.



Figure 30. Sensor 4-Pin Connectors on Multisonde Body (Left) and Probe Sensor (Right)

Prior to initial installation, or when dry, apply a light coat of Krytox grease to the rubber area of the sensor's connector (**Figure 31**). Use the Multisonde Probe Tool to remove/install sensor probes.

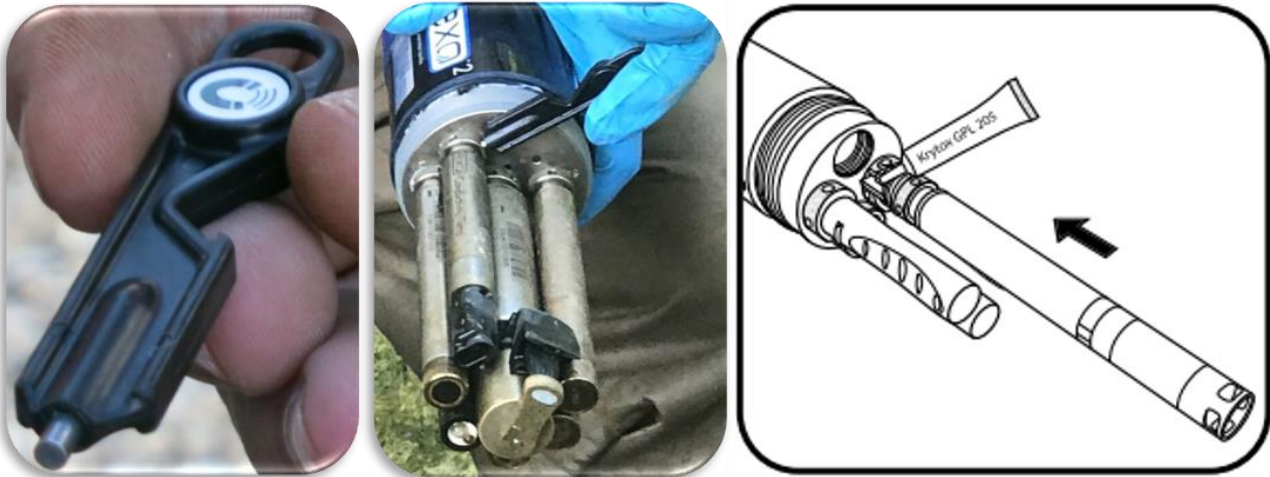

Figure 31. Multisonde Probe Tool and Krytox GPL 205 Lubricant Use

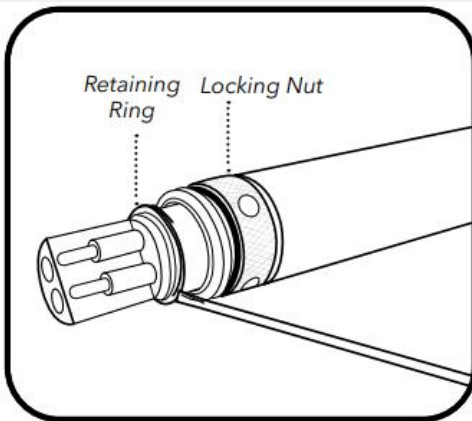

Figure 32. Sensor Locking Nuts & Retaining Ring

Sensor Locking Nuts

If the locking nut near the sensor connector wears out, users can replace it with 599668 (sensor) or 599669 (EXO central wiper). First, remove the retaining ring by inserting the tip of a small, flat-blade screwdriver under the lip of the ring and pry upward. Pull ring out of groove (**Figure 32**). Slide off locking nut and replace with new locking nut. Install new retaining ring by prying up one edge with screwdriver and fitting it into groove. Use the screwdriver to follow the diameter of the ring around the groove to seat it fully.

CAUTION: Wear eye protection when servicing retaining ring.

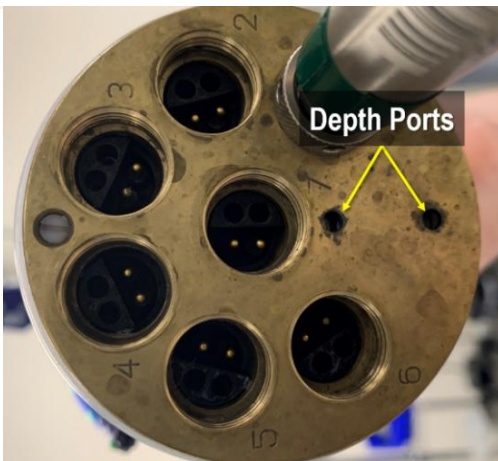

Figure 33. Depth Ports on EXO2 Multisonde

Depth Ports

These ports access water through small holes (ports) from the Multisonde bulkhead (**Figure 33**).

Depth sensors can be stored dry, in water-saturated air, or submerged in clean water. However, be sure that the water does not contain corrosive solutions. This can cause damage to the sensor's strain gauge.



Title: NEON Preventive Maintenance Procedure: AIS Surface Water Quality Multisonde		Date: 04/19/2022
NEON Doc. #: NEON.DOC.001569	Author: B. Nance, D. Monahan, M. Mahal, M. Cavileer	Revision: D

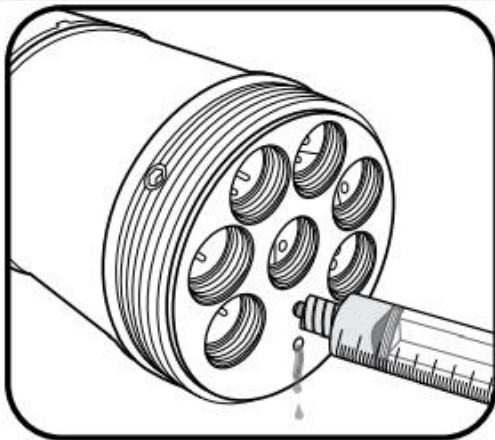



Figure 34. Depth Port Quarterly Maintenance

Depth Port Maintenance

Periodically (quarterly) clean the depth ports with the syringe in the EXO tool kit (599594).

Fill the syringe with clean water and gently force water through one of the ports. Ensure that water flows from the other hole (**Figure 34**). Continue flushing the port until the water comes out clean.

 *Note Do not insert objects in the depth ports, as this may cause damage to the transducer, which is not under warranty.*

5.3.7 Battery Maintenance

EXO2 Multisondes use four (4) D-cell batteries as a power source. The manufacturer states, when using alkaline batteries, users can expect approximately 90 days of deployment from a fully loaded Multisonde that samples once every 15 minutes. However, deployment times may vary greatly depending on water temperature, sampling rate, sensor payload, wiper frequency, and brand of battery. The NEON Program samples every minute in streams, and as a result, we run the sensor off an external power source, not the internal batteries.

On the buoy, the Multisonde receives power from an external solar and battery system to sample every 5 minutes. However, calibrations use the internal batteries, which varies in length across sites, and site-specific variables may influence time to conduct sensor maintenance or affect battery lifespan (e.g., colder sites are likely to encounter shorter battery lifespans and require exchanging the batteries more frequently). When using rechargeable nickel metal hydride (NiMH) batteries, estimated battery life is not available because NiMH batteries vary greatly in manufacturer capacity and discharge curves. YSI recommends using a fully charged NiMH D-cell battery with a minimum rating of 10,000 milliamp hours each time it is replaced.

For remote sites that use a remote/alternative power source, such as a propane fuel cell, diesel generator, or large solar panel/battery bank combination, or sites with intermittent power issues due to infrastructure limitations/unpredictable environmental conditions, the Multisonde will be set to log data internally, which will increase the use of the internal batteries. For sites using the internal logging capability, it is important to monitor and replace the internal batteries of the Multisonde every site visit, and to keep extra batteries on hand.

Physically check the internal batteries/battery compartment every time the Multisonde is removed from its onsite installation for a cleaning and/or calibration. Use the yellow wrench YSI provided with the Multisonde to open/close the battery compartment. Reference **Figure 35** below to replace batteries.

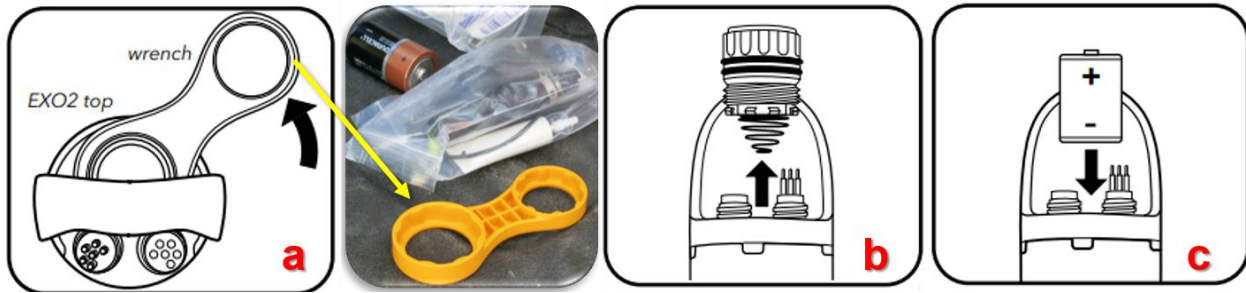

Figure 35. How to Replace Multisonde Internal D-Cell Batteries

Inspecting this compartment aims to verify the internal batteries are not leaking in the compartment and into the sensor body. Leakage from bad batteries can wreak havoc on the sensor internally. It can lead to the loss of all the electronics in the Multisonde body, requiring a replacement.

Bring extra batteries to have on-hand during calibrations in the event something does not go to plan and calibration takes longer than anticipated.

Lastly, do not store the internal batteries in the Multisonde for an extended period. When storing the Multisonde body at the DSF, remove the internal batteries from the sensor body.

5.3.7.1 Battery Compartment O-Ring Maintenance

Periodically check the condition of the O-rings. Ensure that the O-rings are not nicked or torn and that there are no visible contaminants or particles present on the surface of the O-rings or the sealing surfaces inside the battery cover. Wipe away any contamination with a lint-free cloth. Without removing the O-rings from their grooves, lightly grease each O-ring with a thin layer of Krytox 205 lubricant.

Conduct this periodically when the O-rings appear dry and post-sensor refresh/winterization. **Figure 36** provides an example of where to use Krytox for the battery compartment.



Figure 36. Lubricate Battery Cap with Krytox Grease

If the visual inspection reveals a damaged (split, cracked, or misshapen) O-ring, remove and replace it with a new O-ring (**Figure 37**).



Avoid setting O-rings on a workbench or table with dust/dirt. Do not use sharp objects to remove O-rings.

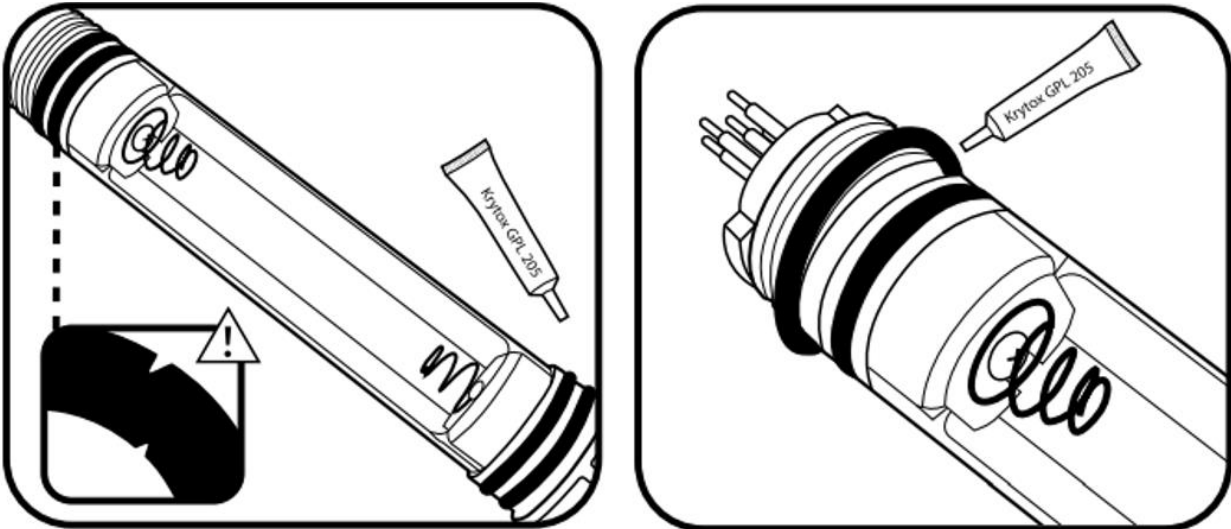

Figure 37. Remove Damaged O-Rings and Replace with Lightly Greased New O-Rings

After removing the damaged O-ring, wipe the groove clean with alcohol and a lint-free cloth. Grease the new O-ring by drawing it between your lightly greased thumb and index fingers. Place the O-ring in its groove, being careful to not roll or twist it, and lightly grease the surface. Inspect the O-ring for contamination before sealing the compartment.

Do not apply excess grease to the O-rings. This can cause contamination and seal failure.

5.3.7.2 Internal Battery Voltage Check

Follow the instructions in **Table 7** below to verify the voltage of the internal batteries to determine if they require replacement before removing the Multisonde from a main utility power source for maintenance activities or in the event of a power outage as a backup method to continue collection sensor data.

Table 7. Internal Battery Voltage Check

STEP 1 | Connect to the Multisonde using the instructions in Section 5.3.8 via **Table 8** or **Table 9**.

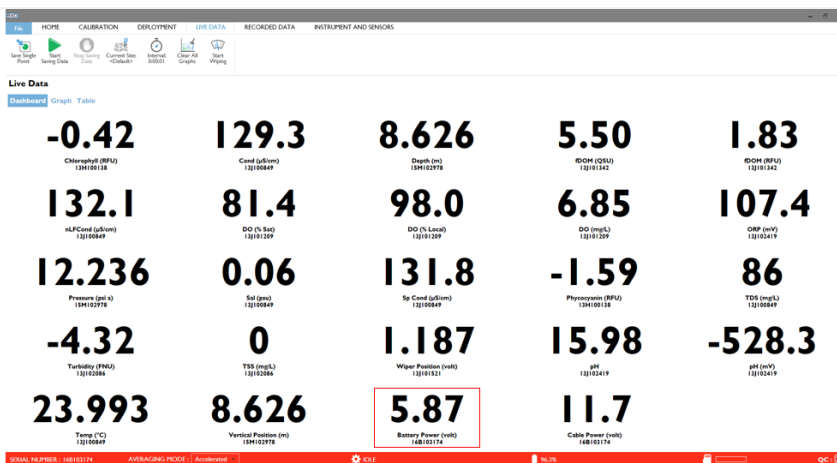

Figure 38. Battery voltage can be found under Live Data

STEP 2 | Battery voltage data is available in the Multisonde Dashboard (Figure 38). Normal voltage for batteries is about 6.4. **If the battery voltage is less than ~5.5 Volts, replace the batteries.** Monitor the battery voltage more often if Field Science is aware the site is experiencing power issues. Reference Figure 35 to replace the batteries.

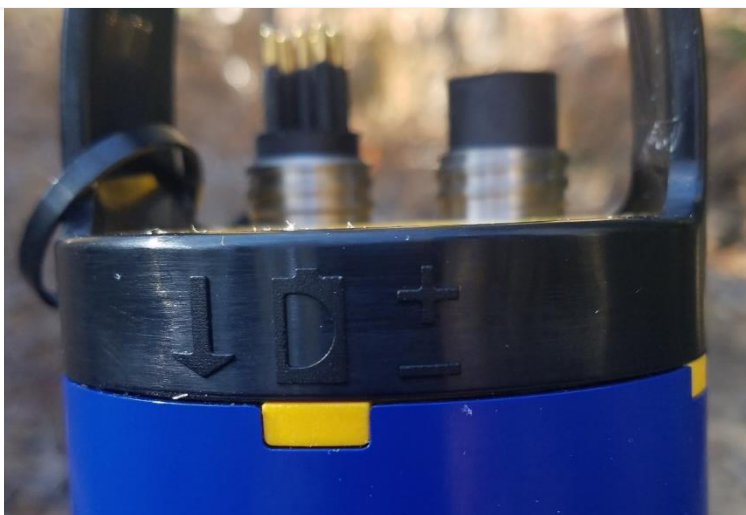

Figure 39. Battery Orientation on Battery Cap

The positive (+) always faces up (Figure 39).

Do not overtighten the battery cap. Overtightening will not create a strong seal and may damage the sensor. When complete, the top O-ring of the cap must be below the battery compartment opening.

5.3.8 Connect to the Multisonde

To determine drift from biofouling and to calibrate Multisonde sensors, technicians must record probe sensor readings prior to cleaning and after cleaning. The Multisonde uses Kor software (see the Resources section in Table 2 to download a copy). The NEON program is calibrating and collecting data products from software version 1.1.8. Use this software version unless otherwise directed by HQ. There are two ways to connect to a Multisonde. Table 8 provides instructions using a USB connection and Table 9 provides instructions using a Bluetooth connection. Follow the steps in Table 16 to connect the Multisonde through Kor software to initiate the field calibration/validation process. For lake and river



sites, have AD [04] handy to understand additional information about the Multisonde Buoy infrastructure.

PRO TIP: At wadeable stream sites, save time and bring two laptops with the Kor software downloaded to collect pre- and post-cleaning or calibrate both S1 and S2 sensors at the same time!

Table 8. How to Directly Connect to the Multisonde using USB

STEP 1 | Acquire the necessary equipment to conduct field maintenance for the Multisondes onsite. This includes cleaning materials per Section 5.3.8, basic tools to remove the central wiper brush, a fully charged laptop with the Kor software and drivers downloaded, USB signal output adapter cable, an extra pair of D cell batteries, waste containers, a couple 5-gallon buckets, powder-free nitrile rubber gloves, calibration cup, black guard, and magnet to wake up the sensor.

PRO TIP: The USB Adapter Cable may require drivers to work. If you have a new laptop or loaner laptop with newly installed Kor software, try to see if Windows will update the drivers for you while you have internet connection at the Domain. Plug the adapter into a USB port on your laptop while connected to the internet. Click the window that pops up in the lower right of the task bar. This should open a Properties window for the USB device. Click the "Driver" tab, and then select "Update Driver".

STEP 2 | Disconnect the Multisonde power source to safely de-energize the instrument and subsystem to prevent hot swapping Grape connections.



Figure 40. Merlot Grape with Signal Output Adapter (Splitter/Converter Box)

STEP 2.1 | Stream sites:

Disconnect the Multisonde 12V Merlot Grape from power by disconnecting the Ethernet cable (RJF) that connects to the Grape (Figure 40).

Always disconnect the RJF cable from the Grape prior to disconnecting (or connecting) any sensor instruments.

Reference AD [10] for the AIS Comm Interconnect Mapping for the Multisonde Grape and AD [06] and RD [09] for procedures on isolating the energy source and ESD.

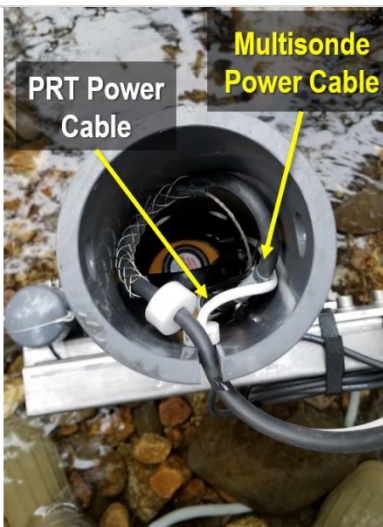

Figure 41. Disconnect the Black Power Cable

STEP 2.2 | Disconnect the black power cable from the Multisonde 6-pin bulkhead connector (**Figure 41**). (The white cable is the power cable to the PRT. Do not disconnect this cable.)

See Section 6.2.1 or AD [09] for removal/replacement instructions for stream sensors.

Buoy Sites: This is where the EXO link connects to the sensor.



Figure 42. Bring the Multisonde up from Vertical Profiling

STEP 2.3 | Buoy sites: De-energize the Buoy to prevent the sensors from transmitting bad data to HQ. The Multisonde is powered by the battery/solar combo through the profiler canister, which mounts to the T-Frame under the yellow buoy housing. Ensure the Buoy is not profiling the Multisonde before accessing the sensor; see Section 6 of AD [04] or RD [06].

Bring the sensor out of the water, onto the Buoy grated deck, and disconnect the EXO Link from the Multisonde 6-pin bulkhead connector (**Figure 42**).

Reference AD [10] for the Profile Canister interconnect map.

STEP 3 | Remove, move or make the sensor accessible to connect it to its calibration cable or connect through Bluetooth. Skip to **Table 9** for instructions on how to connect to the sensor via Bluetooth. See Section 6.2 remove the Multisonde from streams and AD [05] and AD [09].

See AD [04] to remove the Multisonde from the AIS Buoy.

STEP 4 | Connect to the sensor using a USB Signal Output Adapter (SOA). **Figure 43** provides an overview of each connection point. This connector may require drivers to function with a laptop, ensure those are downloaded prior to traveling to the field and the laptop battery is fully charged.



Figure 43. Connect to Multisonde using a USB SOA

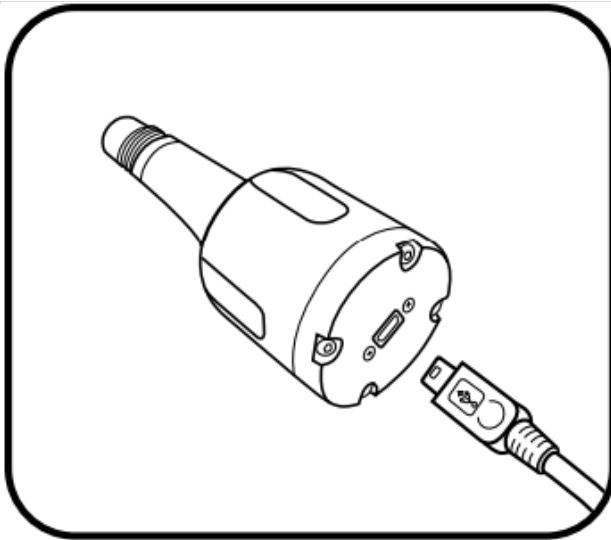

Figure 44. Insert Small End of USB Cable into SOA Connector

STEP 5.1 | Remove the protective cap from the USB end of the SOA, and ensure that the connector is clean and dry. Then insert the small end of the provided USB cable into the SOA connector and the large, standard side into one of the PC's USB ports (**Figure 44**).

Attaching the adapter to the PC causes a new device to be recognized. Windows automatically installs the drivers and creates a new port. Each new adapter that is attached creates a new port.

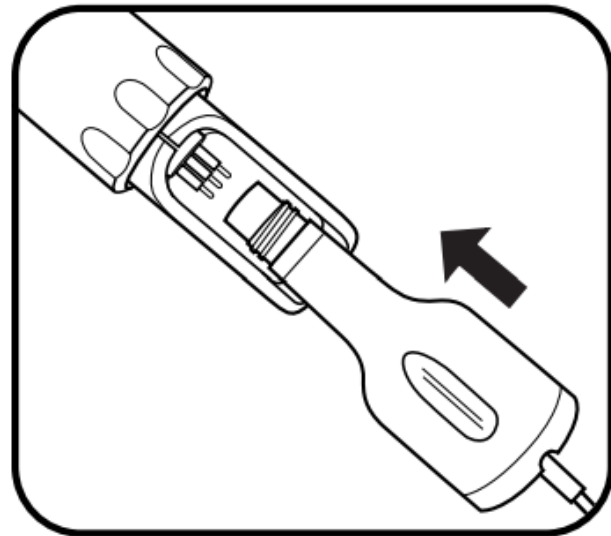

Figure 45. Align the Connector's Six Pins and Jackets with Sensor

STEP 5.2 | Remove the plug from the male 6-pin connector on the Multisonde.

If the pins are dry, apply a light layer of Krytox grease to the male pins on the Multisonde and the female connector on the USB-SOA.

Then align the connector's six pins and jackets, and press them firmly together so that no gap remains (**Figure 45**).



Title: NEON Preventive Maintenance Procedure: AIS Surface Water Quality Multisonde		Date: 04/19/2022
NEON Doc. #: NEON.DOC.001569	Author: B. Nance, D. Monahan, M. Mahal, M. Cavileer	Revision: D



Figure 46. Complete Connection to Multisonde using a USB SOA

Figure 46 displays the complete connection: USB to USB-SOA to EXO Multisonde.

Kor automatically scans ports for USB adapters. To view the USB adapter and its associated com port, go to the **Control Panel** on your computer, click **Device Manager**, and then click **Ports**.

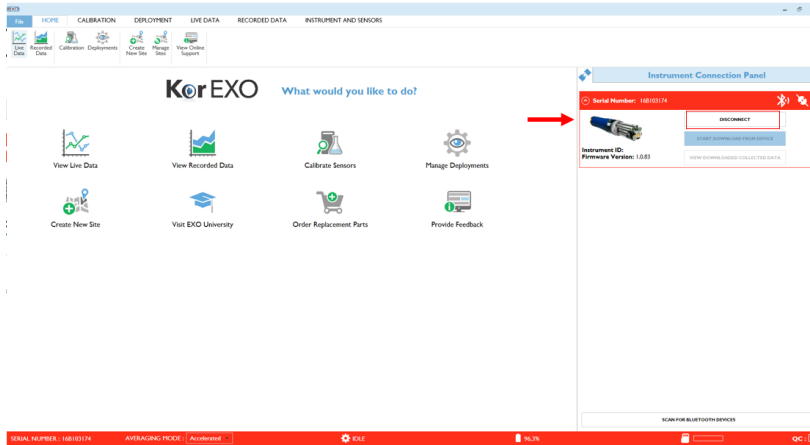

Figure 47. Multisonde will automatically appear here.

STEP 5.2 | Launch the Kor software on a laptop. The EXO Sonde should appear in the **Instrument Connection Panel**.

Select the Multisonde (e.g., COM3 – EXO USB Adapter in **Figure 47**) and then select the **“CONNECT”** button to establish communication with the sensor.

The PC connection via the SOA will supply power to the EXO Sonde, so batteries are not necessary to power the sensor when directly connected.

If the Multisonde does not show up, click on the rescan button (**Figure 47**).

Table 9 below provides instructions on how to connect to the Multisonde using Bluetooth. Use this method if the Multisonde is receiving power from an external source. The port for an external power source is the same port to connect to the Kor software; therefore, in this scenario, you must use Bluetooth for the sensor to connect to the Kor software. It may take up to five minutes for the Multisonde software to discover our laptops.



Note for AIS Buoy sites: Do not connect to the Multisonde via Bluetooth when the Buoy is powered and the sensor is connected to the buoy. If the buoy is not powered, then it is OK to connect to Bluetooth.

Table 9. How to Connect to a Multisonde using Bluetooth

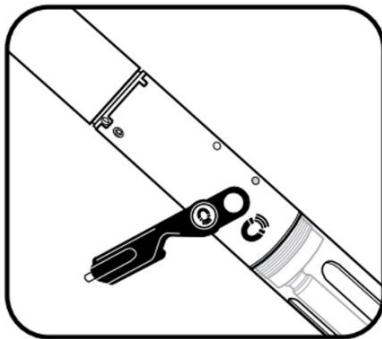

Figure 48. Wake up the Multisonde!

STEP 1 | Activate the Multisonde’s Bluetooth. Use a magnet or Multisonde tool in the area shown in **Figure 48** and **Figure 49**. This is the best way to access the sensor while it is connected to an external power source.

Note: *If the Multisonde internal batteries drops below 5.5 Volts, this connection method may not work. Field Science can use this method to connect to the Multisonde while it is still receiving power from the Grape.*

PRO TIP: *If you are unable to wake up the sensor using the magnet or Multisonde tool, remove the battery cover to activate the sensor.*



Activate sonde’s Bluetooth

Users activate *Bluetooth* by holding a magnet at the magnetic activation area in the same way as described in Step 1. In addition to magnetic activation, users can also activate *Bluetooth* by:

- Cycling power to the sonde (uninstalling/installing batteries).
- Enabling *Bluetooth* via a connection at the topside port using KorEXO.

Figure 49. Activate the Multisonde’s Bluetooth Capability [Source: [ER \[02\]](#)]

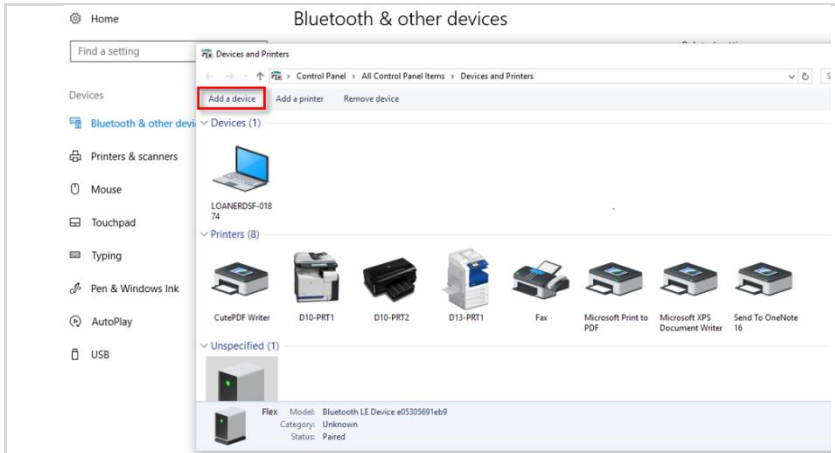



Figure 50. Open "Devices and Printers" Window and Select "Add a device"

STEP 2 | Using a laptop, open the **Devices and Printers** window and select **Add a device** add the Multisonde (**Figure 50**).



Figure 51. Add YSI Device

STEP 3 | Add YSI Device. Anything unknown with the symbol in **Figure 51** is likely the Multisonde. Sometimes the name does not appear.

 **Note:** *This step may take up to five minutes for it show up, and may take a few attempts to search/connect. Be patient and continue refreshing and searching for the device. Bluetooth range is approximately ~15 meters.*

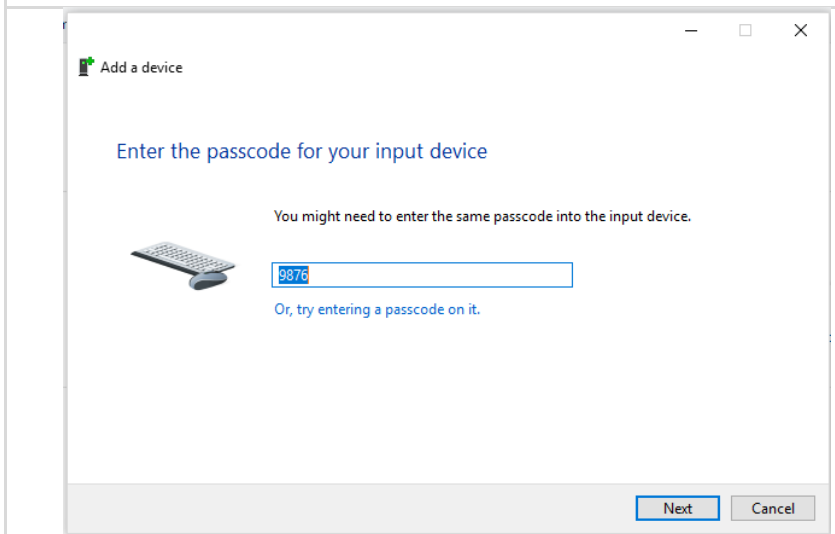

Figure 52. Enter Passcode to Access Device

STEP 4 | After selecting the Multisonde, a pop-up window appears requesting a passcode.

Enter the following passcode to access the device: **9876** (**Figure 52**).

Select **"Next"** when complete.

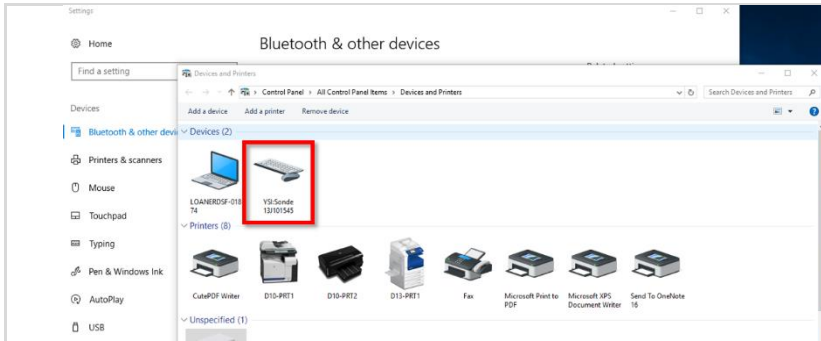

Figure 53. Successful Connection using Bluetooth

When the laptop connects via Bluetooth, the Multisonde will appear in the Devices list (Figure 53).

After performing this setup once, the computer will be able to connect to any Multisonde with Kor software.

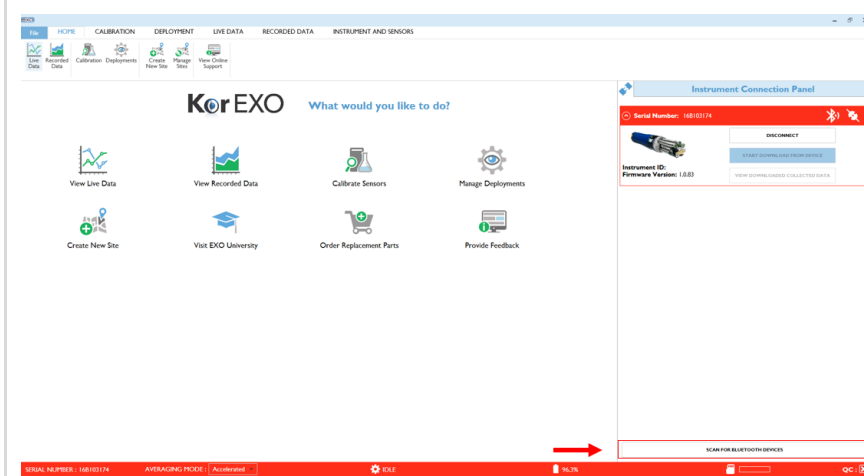

Figure 54. Scan for Bluetooth Devices from main dashboard.

STEP 5 | Once device settings are setup, launch the Kor software to connect to the Multisonde.

Select Scan for Bluetooth Devices button in Main Dashboard. Technicians may need to repeat this step several times before the software finds the sensor.

When the sensor appears, click the **“Connect”** button next to the image of the sonde.



Figure 55. Example/Location of Bluetooth Blue LED

On the sensor, a blue LED indicates whether Bluetooth is on or active.

- If the blue LED is solid, it means Bluetooth is enabled, but not linked to a device. **Figure 55** is an example of a solid blue LED.
- If the blue LED is blinking, it means Bluetooth is enabled and linked to a device.

PRO TIP: The Red LED displays the sensor's power status. This LED is only a concern if it is continuously lit. If so, the sensor has detected faults that need to be addressed before redeploying.

5.3.9 Collect Pre-Clean and Post-Clean Reading

To evaluate the effects of biofouling on sensor measurements, record a reading on each probe sensor before cleaning them, and then again after cleaning them. The result is the "Pre-Clean Reading" and "Post-Clean Reading". These values help evaluate sensor drift from biofouling. Follow the instructions in **Table 10** to complete this procedure.

Note: Use the sensor anti-fouling guard when collecting the pre- and post- cleaning values. **Ensure the anti-fouling guard is NOT clean before collecting the pre-cleaning. Only clean the guard after collecting the pre-cleaning value.**

PRO TIP: At wadeable stream sites, save time and bring two laptops with the Kor software downloaded to calibrate both S1 and S2 sensors at the same time!

Table 10. How to Collect Pre-Clean and Post-Clean Readings/Values

STEP 1 | Acquire the necessary equipment to complete this procedure onsite. This includes materials to clean the anti-fouling guard and sensor probes per Section 5.3.4 and 5.3.10, a 5-gallon bucket, fully charged laptop with Kor software version 1.1.8 and cable to connect the laptop to the sensor (disregard the cable, if connecting through Bluetooth).



Figure 56. Antifouling Guard on Multisonde

STEP 2 | Do not clean the copper antifouling guard (**Figure 56**). Use it to collect the dirty pre-clean reading.

See the next Section, Section 5.3.10 for specific cleaning instructions.

STEP 3 | Collect stream, river or lake water in the 5-gallon bucket. Collect enough water to submerge the sensor probes. The bucket provides a controlled environment for readings, which aims to minimize the potential for upstream or cross-lake inputs inferring a difference where one does not exist. For this reason, we want to ensure the pre- and post-cleaning readings are from water with the same chemical constituency. Field Science technicians must use the same water to measure pre and post clean values. To streamline this process, collect all four measurements in the same water sample (i.e., pre-, post-cleaning, pre-, and post-calibration readings).



Note: The buckets may increase the temperature of the water sample, if left in the sun for unanticipated longer durations. Maintain awareness of the temperature, and control it by keeping the bucket in the shade and/or in the stream until the field calibration/validation process is complete. If the water in the bucket begins to freeze, cease cleanings and submit a ticket to notify HQ for data quality purposes.

STEP 4 | Connect to the Multisonde. See Section 5.3.8 for specific instructions.

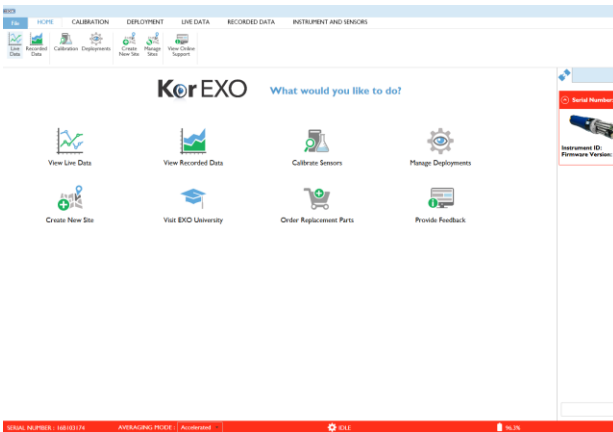

Figure 57. Example of Kor dashboard.

STEP 5 | Install the uncleaned sensors including the uncleaned anti-fouling guard and collect a stabilized pre-clean reading.

A pre-cleaning read-out is a snapshot of raw data output from the sensor (**Figure 57**).

Navigate to the Dashboard in the Kor Software by selecting the Runner icon in the top left banner on the screen identified in **Figure 57**.



PRO TIP: The white information box is red (as shown in Figure 57 above in the upper right hand corner of the screen) when the sensor is storing a fault code. A fault could be something as simple as low D batteries or an indication of a hardware issue. To find out what the fault means, connect to the Multisonde via the Kor software and click on the Options icon, and then the Multisonde button. On this screen, the "Fault bit field" section will have an Explain button. Click on the Explain button to determine the fault. Submit an incident ticket with the fault information to AIS Science/Advanced Engineering stakeholders.



Figure 58. Pre-Cleaning and Post-Cleaning Examples

STEP 6 | Clean each sensor probe. Follow the instructions to clean each probe per Section 5.3.10.



Figure 59. Capture Post-Clean Reading using Same Bucket of Water

STEP 7 | After cleaning the probes and copper guard, reinstall the cleaned copper guard and collect a post-clean reading. (Ensure the copper guard is clean prior to installing on the sensor.) Record a stabilized post-clean reading.

Use the same water in the bucket that was used for the pre-clean reading.

Figure 59 displays an example of this in the DSF Lab.

The objective of this process is to collect data to determine the impact of biofouling on the data across sites.

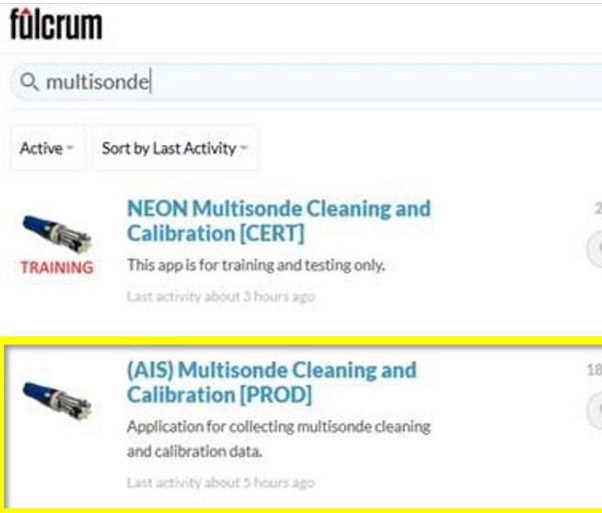

Figure 60. Submit Pre-clean/Post-clean Results in Fulcrum

STEP 8 | Submit the pre-clean/post-clean results electronically via the Fulcrum application (Figure 60).

Submit an incident ticket, if issues are encountered while conducting this procedure.

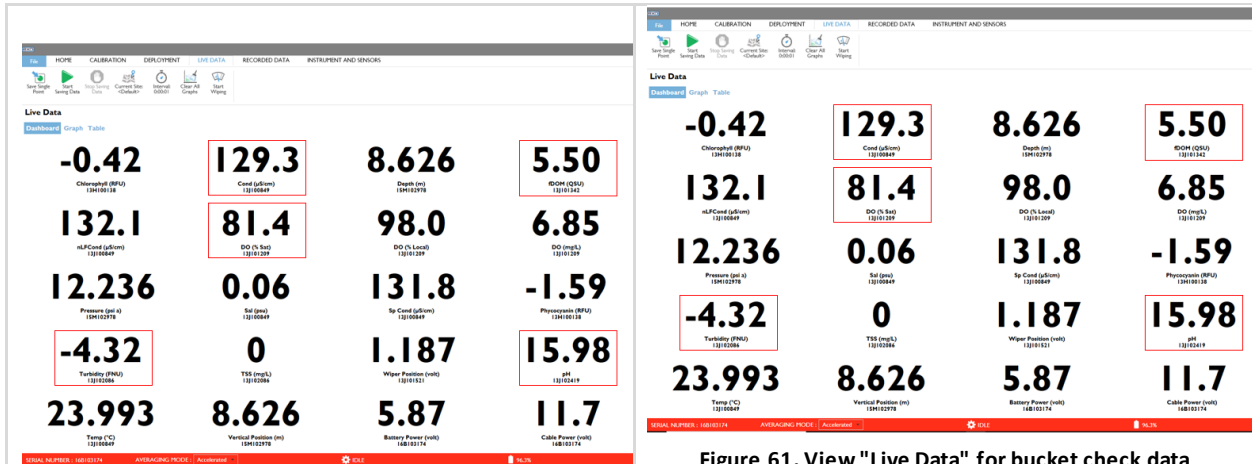

Figure 61. View "Live Data" for bucket check data

Figure 61. View "Live Data" for bucket check data
Figure 61 provides an example of what measurements to capture for the Multisonde's pre- and post-cleaning measurements. Input this information into the Fulcrum Application shown in Figure 60.

STEP 8 | If the Multisonde was not calibrated on the previous site visit, move on to the next section, Section 5.4, to calibrate each sensor probe. Conduct the calibration procedure every four (4) weeks, post-sensor refresh, and after any repairs (which includes any sensor the Domain receives from HQ), as well.

5.3.10 Biweekly Probe Sensor Cleaning Procedures

Biofouling is the growth of organisms (algae, plants, microorganisms, etc.) on the surface of water quality/chemistry sampling instruments. Biofouling may have negative impacts on AIS instrument data and on the lifespan of instruments. Since the initial deployment of an AIS site, we have observed the negative effects biofouling has on data collection. In one particular instance, chlorophyll data was out of its expected range due the growth of green algae on the optical sensing lenses. A significant amount of Multisonde field PM focuses on controlling the influence of biofouling on the sensors. The central wiper and copper anti-fouling guard are two anti-fouling components that aim to prevent biofouling accumulation on the sensor; however, these preventions are not enough alone. The sensor requires manual routine cleanings.

Removing biofouling allows AIScience the opportunity to quantify the site-specific effects of biofouling on specific sensors in our data products. In order to quantify the effects of biofouling, Field Science must collect pre- and post-cleaning sensor data for each sensor from the same bucket of water. This enables the future correction of data and provides data to inform, and possibly predict in the future, how often certain sites need to clean biofouling off their Multisonde probe sensors.



5.3.10.1 Turbidity, Chlorophyll, and fDOM Optical Sensor Probes

Optical sensor lenses are made of sapphire to protect the windows of these probes. Clean the sapphire lenses using the guidance below. Use the following equipment: powder-free rubber gloves, lint-free cloths, DI water, green plastic scrub pads (NO METAL), and isopropyl alcohol.

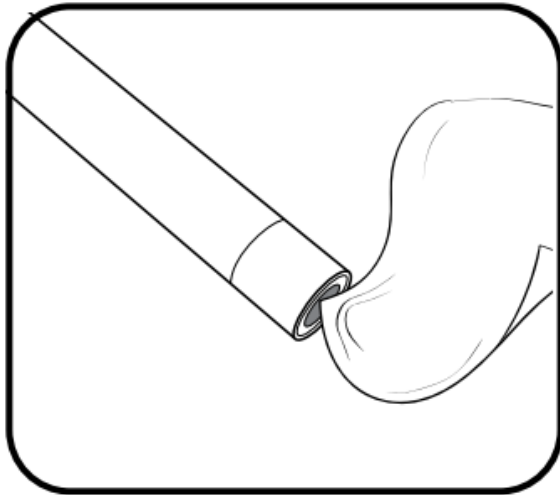

Figure 62. Clean Optical Sensor Windows

Inspect the optical surface at the tip of the sensor and wipe it clean with a lint-free cloth and DI water, if necessary. As much as possible, prevent scratches and damage to the sensing window when handling and cleaning these probes. Be aware, large scratches to the sensing window may affect the sensor’s ability to accurately measure.

For stubborn biofouling, use isopropyl alcohol instead of DI water to clean this sensor.

Wear powder-free rubber gloves when cleaning sensor probes.



Figure 63. Example of Biofouling on Sensor Probes

If a significant amount of biofouling has accumulated on the sensing window, Technicians may use a green plastic scotchbrite scrub pad or equivalent, as long as there is no metal material in the pad. The optical sensing windows are sturdy enough to handle deliberate scrubbing on areas where thick biofouling accumulation is present.

Figure 63 is an example of a high amount of biofouling on the probes.

Submit an incident ticket if you are unable to remove biofouling from these sensor probes.

5.3.10.2 Dissolved Oxygen (DO) Optical Sensor Probe

Dissolved Oxygen sensors require specific maintenance instructions because of their sensitive sapphire lenses. Field Science Technicians should routinely perform these steps in order to achieve the highest levels of sensor accuracy. **Do not use isopropyl alcohol to clean this sensor. Never use organic solvents to clean a DO sensor.**

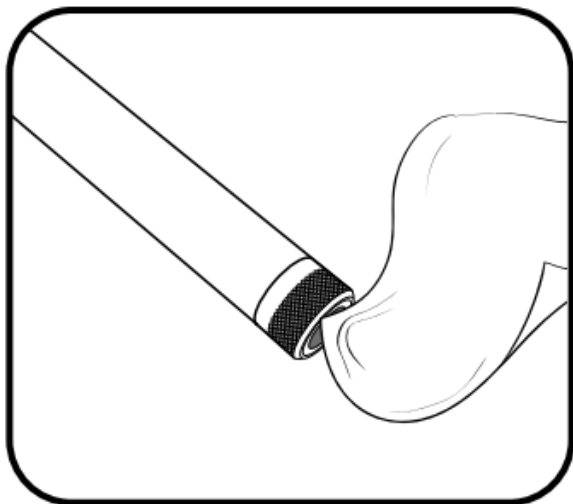

Figure 64. Clean DO Probe Sensor

Field Science Technicians should periodically inspect the optical surface at the tip of the sensor and wipe it clean with a non-abrasive, lint-free cloth, if necessary (**Figure 64**).

Wear powder-free rubber gloves when cleaning sensor probes.

As much as possible, prevent scratches and damage to the sapphire sensing window. Avoid getting fingerprints on the window. If necessary, wash with warm water, dish soap, and rinse with DI water.

Submit an incident ticket if you are unable to remove biofouling from the sensor probes.

5.3.10.3 pH/ORP Sensor Probes

Clean the pH/ORP probe sensors of deposits, biofouling or other. **Do not attempt to physically scrub or swab the glass bulbs. The bulbs are fragile and break, if pressed with sufficient force.**

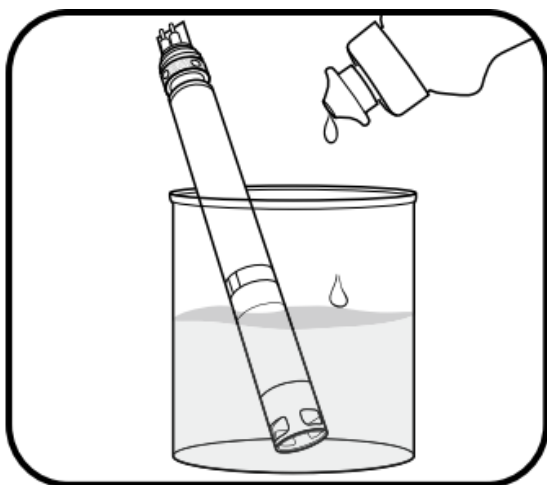

Figure 65. Clean pH/ORP Sensor Probe

If you are unable to clean the biofouling using DI and a kimwipe, soak the sensor for 10-15 minutes in a solution of clean tap water and a few drops of dishwashing liquid (**Figure 65**). Following the soak, rinse the sensor with DI water and inspect.

Wear powder-free rubber gloves when cleaning sensor probes.

If contaminants remain or response time does not improve, continue to the vinegar soak.

Submit an incident ticket if you are unable to remove biofouling from the sensor probes.



Title: NEON Preventive Maintenance Procedure: AIS Surface Water Quality Multisonde		Date: 04/19/2022
NEON Doc. #: NEON.DOC.001569	Author: B. Nance, D. Monahan, M. Mahal, M. Cavileer	Revision: D



Figure 66. Example of Biofouling on Sensor Probes

Figure 66 is an example of medium accumulation of biofouling on the pH/ORP sensor probe.

Submit an incident ticket if you are unable to remove biofouling from the sensor probes.

5.3.10.4 Conductivity & Temperature Sensor Probe

The conductivity and temperature (C/T) sensors require minimal maintenance. As much as possible, prevent impact to the sensor's exposed thermistor. The only parts of the conductivity and temperature sensor that require special maintenance are the channels leading to the internal electrodes.

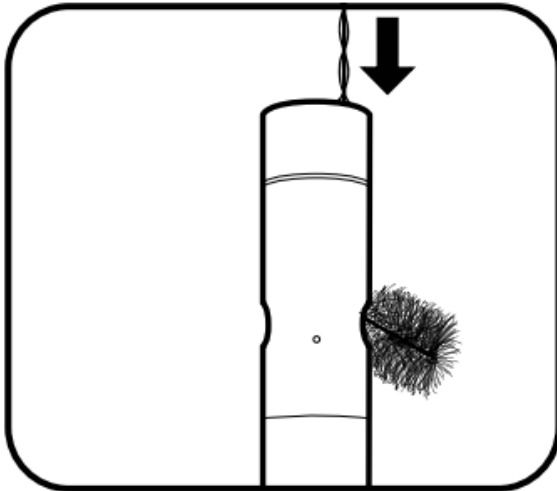

Figure 67. Clean Conductivity & Temperature Sensor Probe



Figure 68. YSI C/T Sensor Cleaning Brush SKU: 599470

Clean electrode channels with a brush provided by YSI with the sensor (**Figure 68**).

Wear powder-free rubber gloves when cleaning the sensor probe.

Dip the sensor cleaning brush (included in the Multisonde maintenance kit) in clean water, insert at top of channels, and sweep the channels 15-20 times (**Figure 67**).

If deposits have formed on the electrodes, use a mild solution of dish soap and water to brush the channels.

If necessary, soak in white vinegar to aid cleaning. Rinse the channels with clean water following the sweepings or soak.

Submit an incident ticket if you are unable to remove biofouling from the sensor probes.

5.4 Field Calibration Procedure

Calibrate the Multisonde every four (4) weeks in the field. Review the following sections first before conducting calibrations in the field. Reference Section 5.4.2.10 for calibration pass, fail and override requirements.

***Note:** Do not calibrate the Multisonde if the calibration solutions/DI water start to freeze or if Technicians are unable to safely access the sensor. Submit a ticket to notify AIS Staff that the Domain was unable to calibrate the sensor due to freezing temperatures or unanticipated safety hazards.

5.4.1 Domain Lab Preparation

This procedure is first because it requires additional preparation time in the Domain Support Facility and onsite with the Multisonde sensor. Each Domain maintains a Chemical Hygiene Plan and Biosafety Manual; reference this manual for guidance on working with calibration chemicals in lab and in the field. Follow instructions for PPE per the NEON Program’s Safety Office and the Chemical SDS.

5.4.1.1 Calibration Solution Lot Numbers

The lot (or batch) number “is an important element of quality control. It identifies the run during which the calibration solution was produced. If calibration solutions have the same batch number, they were



Title: NEON Preventive Maintenance Procedure: AIS Surface Water Quality Multisonde		Date: 04/19/2022
NEON Doc. #: NEON.DOC.001569	Author: B. Nance, D. Monahan, M. Mahal, M. Cavileer	Revision: D

produced from the same starting materials under the same conditions”¹. **Figure 69** displays an example of lot numbers on various calibration solutions.

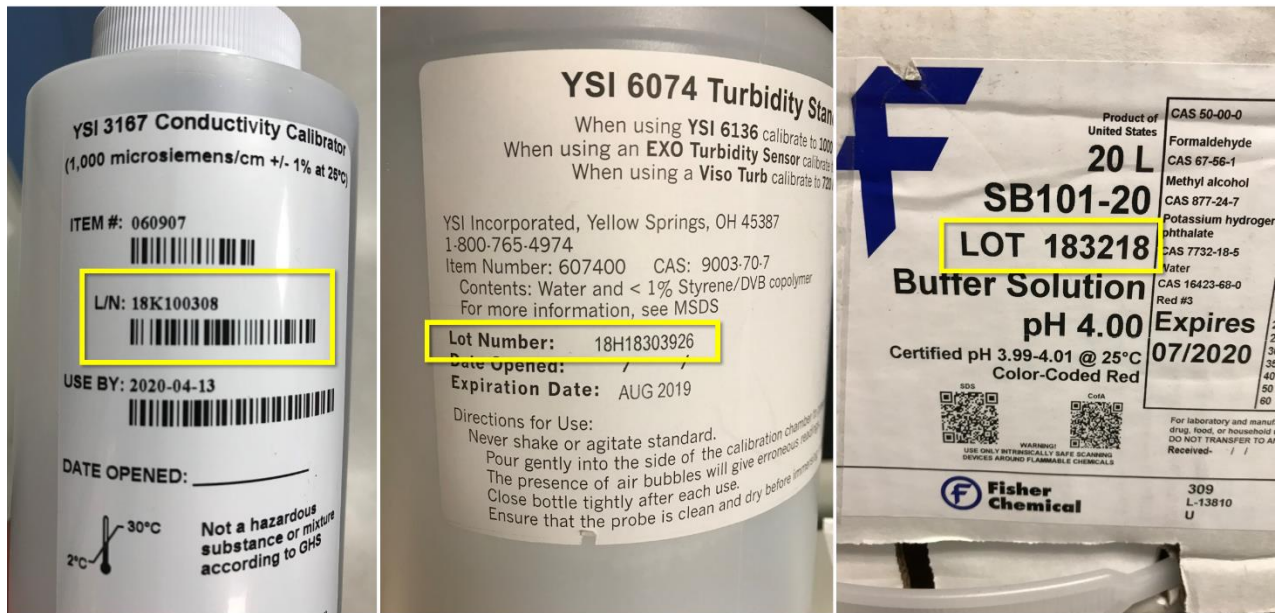

Figure 69. Lot Numbers on Multisonde Calibration Solutions

For solutions CVAL is providing Field Science, the solution lot numbers are located on the label as shown in **Figure 70**.

¹ <https://es.hach.com/asset-get.download.jsa?id=25593611788>



Title: NEON Preventive Maintenance Procedure: AIS Surface Water Quality Multisonde		Date: 04/19/2022
NEON Doc. #: NEON.DOC.001569	Author: B. Nance, D. Monahan, M. Mahal, M. Cavileer	Revision: D

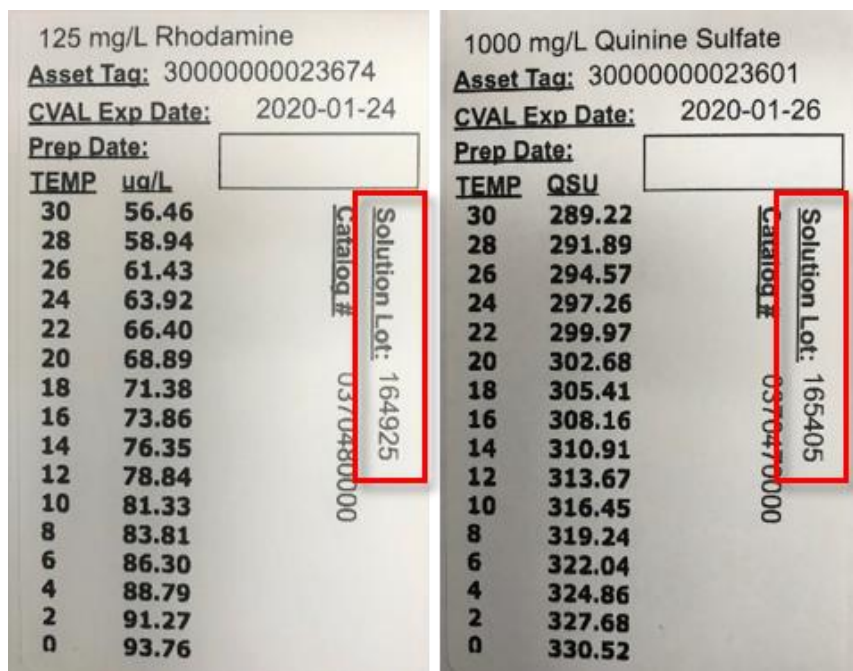

Figure 70. Solution Lot Numbers for Rhodamine and Quinine Sulfate

Know stock solution lot numbers before heading to the field to calibrate the Multisonde. During the field component of the calibration procedure, Technicians must input the stock solution lot numbers into the Kor Software. Review the procedure in **Table 16** to understand the calibration process to verify materials and information required to complete the process when in the field.

PRO TIP: Technicians may set up certain fields to auto-populate information in the Kor software during cleanings/calibrations. Specifically, manufacturer (MFG) names and changing Conductivity from 10000 to 1000. See Section 8 for instructions on how to make these changes.

5.4.1.1.1 Wet Chemistry Best Practices

To maintain calibration solutions, employ basic good chemistry practices. To avoid contamination, never place a solution directly into the stock solution bottle. An aliquot of solution should always be poured into a secondary container (e.g., a beaker) that has been rinsed / primed with the solution first. Be aware that if the container is newly washed and has water remaining, as this will affect the final concentration – ideally, the secondary container should be air-dried and rinsed with the solution prior to filling. Triple rinse glassware with DI then single rinse with solute if different (e.g., Sulfuric Acid). For fDOM and Chlorophyll (Chla), always mix the stock solution before making a calibration solution. Mix the solution by inverting the bottle 3-5 times.

Pipetting

CVAL recommends the following equipment in **Table 11**.



Title: NEON Preventive Maintenance Procedure: AIS Surface Water Quality Multisonde		Date: 04/19/2022
NEON Doc. #: NEON.DOC.001569	Author: B. Nance, D. Monahan, M. Mahal, M. Cavileer	Revision: D

Table 11. Solution Preparation Equipment

Item	Description	Item Number	Brand
5mL Pipette	5 mL Pyrex Volumetric Pipette Class A	7103C-5	Pyrex
10mL Pipette	10 mL Pyrex Volumetric Pipette Class A	7103C-10	Pyrex
1mL Pipette	1 mL Pyrex Graduated Pipette Class A	7070-1	Pyrex
2L Flask	2 L Pyrex Volumetric Flask Class A	5640-2L	Pyrex
Pipette Stand	Cast Iron Support Ring Stand, 8"x 5"	7-G15-A	American Educational
Pipette Stand Clamp	Double Burette/Tube Clamp, 7/8" Width Capacity	CH0258B	Eisco
Pipette Bulb	Three Valve Rubber Pipette Filler, 54mm Diameter	CH0580A	Eisco
Pipette Pump	2 mL Blue Pipette Pump	F37897-0000	Bel-Art
Pipette Controller	Macro Pipette Controller, 0.1-200 mL	26202	BrandTech
Absorbent Liner	Absorbent Liner Roll, 20"x 3600"	AL20300	Jaece Industries

- Prime pipette with liquid first, and discard as waste. Pull fresh aliquot for measurement.
- For volumetric pipettes, be aware of TD (To Dispense) and TC (To Contain) measurement lines.
- For graduated pipettes, do not dispense below the 1 mL measurement line. The measurement is a differential between two markings. Reference **Figure 74** for a reference of these measurement lines.

5.4.1.2 Calibration Solution Requirements

Table 12 below provides a description of calibration solution requirements and creation instructions from stock solutions (fDOM and Chlorophyll/Chla) to calibrate each probe sensor. Field Science must prepare these solutions prior to each calibration event. Wear the required PPE to handle each solution per Safety and Field Science laboratory guidance per the Domain’s Chemical Hygiene Plan and Biosafety Manual. At a minimum, these are safety glasses and gloves. CVAL provides two bottles of two stock solutions to create calibration solutions for Chlorophyll and fDOM. This is to ensure consistency and traceability of the solution concentration to NIST standards.

Table 12. Calibration Solution Requirements and Creation Instructions

Sensor	Calibration Solution Requirements and Instructions
Chlorophyll <i>a</i> (Chla/Total Algae)	This sensor requires a two-point calibration. One standard must be fresh de-ionized water (0 µg chlorophyll/L) and the second standard is with Rhodamine WT solution. CVAL provides Field Science two 1 L stock solutions for Chla, 125 mg/L Rhodamine WT. This solution has a 1-year shelf life. To avoid having to coordinate replacements with exact expiration dates, CVAL ships a new solution bottle every six months. Once Field Science receives the replacement solution, return the remaining stock solution and bottle to CVAL. CVAL evaluates the returned solution for drift. CVAL aims to have 3 bottles in rotation, with 2 at each domain at all times. Note that one bottle of each solution is more than sufficient for 6 months. The second bottle is for back up, if the solution spills or Field Science suspects contamination. The solution ships in brown opaque HDPE. Storage in the Domain requires refrigeration. Stock Solution Creation Instructions (see Section 5.4.1.1.1 for required glassware): Field Science prepares this solution in the DSF using a 1000 mL volumetric flask. Transfer 5 mL of stock solution (~125 mg/L) into the flask using a volumetric pipette. Flush the pipette with a squirt bottle of fresh DI water to rinse all contents into solution. Fill the flask to volume with DI water. Do



Sensor	Calibration Solution Requirements and Instructions
	<p>not put pipette directly in the stock solution bottle. Pour a small amount into a beaker and pull solution from that aliquot. Do prime the pipette with solution first and discard into a waste beaker. (Use 10 mL of stock solution if preparing 2 L calibration solution.) The 0.625 mg/L calibration solution expires after 24 hours. The solution is light sensitive. CVAL recommends using an amber bottle or wrap bottle in foil. This calibration solution requires temperature correction. <i>See Section 5.4.1.2.3 for supporting information and examples.</i></p>
<p>Conductivity</p>	<p>This sensor requires a one-point calibration. It requires the use of 1000 $\mu\text{S}/\text{cm} \pm 0.1\%$ via a YSI 500 mL bottle. Do not open the bottle until it is time to calibrate the sensor in the field. Store these bottles in their factory-direct containers at room temperature. The bottle must be unopen prior to calibration to maintain the integrity of the solution. Do not use opened or past calibration date solutions. It is OK to use opened bottles to rinse, but never to calibrate. This calibration solution requires temperature correction. <i>See Section 5.4.2.3 for supporting information and examples.</i></p>
<p>DO</p>	<p>This sensor requires a one-point calibration. The field calibration of DO sensors uses 100% saturated air onsite. This calibration requires approximately 1 cm of DI water in the calibration cup to reach equilibrium with the surrounding ambient air. There are no pre-site visit preparation requirements. However, this sensor requires DI water when placing it in storage and/or shipping back to HQ. <i>See Section 5.4.2.8 for supporting information and examples.</i></p>
<p>fDOM</p>	<p>This sensor requires a two-point calibration. One standard must be fresh de-ionized water (0 μg QSU) and the other standard should be approximately 300 $\mu\text{g}/\text{L}$ quinine sulfate solution. CVAL provides Field Science two 250 mL stock solutions for fDOM, 1000 mg/L quinine sulfate in 0.1N H₂SO₄. This solution has a 1-year shelf life. To avoid having to coordinate replacements with exact expiration dates, CVAL ships a new solution bottle every six months. Once Field Science receives replacement solution, return any remaining stock solution and bottle to CVAL. CVAL evaluates returned solution for drift. CVAL aims to have 3 bottles in rotation, with 2 at each domain at all times. Note that one bottle of each solution is more than sufficient for 6 months. The second bottle is for back up, if the solution spills or Field Science suspects contamination. The solution ships in brown opaque HDPE container. Storage in the Domain requires refrigeration. Do not store any sensor in quinine sulfate solution. Stock Solution Creation Instructions (see Section 5.4.1.1.1 for required glassware): Field Science prepares 300 $\mu\text{g}/\text{L}$ of calibration solution in the Domain Support Facility using graduated pipette. First, transfer 0.3 mL of stock solution into a 1000 mL volumetric flask half filled with 0.1 N H₂SO₄. (Use 0.6 mL of stock solution if preparing 2 L calibration solution and bring to volume with H₂SO₄.) Do not dispense volume below the 1 line at the bottom of the graduated pipette. The solution expires in 5 days. This solution is light sensitive; handle and travel to site protecting the solution from the sun (wrap in foil or use an opaque HDPE bottle when transporting). This calibration solution requires temperature correction. <i>See Section 5.4.1.2.2 for supporting information and examples.</i></p>



Title: NEON Preventive Maintenance Procedure: AIS Surface Water Quality Multisonde		Date: 04/19/2022
NEON Doc. #: NEON.DOC.001569	Author: B. Nance, D. Monahan, M. Mahal, M. Cavileer	Revision: D

Sensor	Calibration Solution Requirements and Instructions
pH & ORP	This sensor requires a three-point field calibration with 4, 7, and 10 pH buffer solutions. Science requirements allows for the use of either 20 L carboys or 4 L bottles of 4, 7, and 10 buffers. Field Science must maintain the buffer solutions in lab conditions (room temperature) in order to use them to calibrate the pH probe. For buffers in carboys, lab conditions allow Field Science to transfer and store the solutions into smaller containers. Once a buffer solution is transferred into a smaller container, it expires within five calendar days. The buffer solutions are only viable for calibration use within those 5 days. Additionally, this sensor requires 4 pH buffer solution when storing and/or shipping back to HQ. Field Science may rinse the pH probes with opened or expired pH solution. Only use fresh solutions for calibrations. This calibration solution requires temperature correction. <i>See Section 5.4.2.7 for supporting information and examples.</i>
Turbidity	This sensor primarily requires a three-point calibration for stream/river sites and two-point calibration for lake sites and TOOL. If the Turbidity measurement is outside the range for a two-point or three-point calibration for your lake/river or stream site, respectively, submit an incident ticket to notify AIS Science to determine if a two-point calibration site requires a three-point calibration and vice versa. Turbidity is calibrated using a styrenedivynlbenzine copolymer standard. The first standard is 0 FNU (DI water). The other two standard turbidity values are 124 and 1010 FNU. Store these solutions in the DSF lab at room temperature. In the lab, turbidity standards expire one year after manufacture, and six months after opening. Do not allow these standards to freeze. <i>See Section 5.4.2.4 for supporting information and examples.</i>

Arrive on site with all solution temperatures as close to site ambient temperature as possible. This will reduce the temperature fluctuations during calibration and enable the likelihood of a more accurate and successful calibration. To achieve this, consider storage conditions of the calibration solutions 12 hours prior to use at the site. This may require different handling/storage of solutions throughout the year and may include the following actions:

- Using a cooler
- Storing in equal volumes
- Storing outside the night prior to departure to the site
- Keeping the solutions out of direct sunlight

5.4.1.2.1 Stock Solution Tracking

CVAL and AIS Science oversee and manage the quality of stock solutions using the Fulcrum application via the (AIS) Calibration Solution Tracking application and the (AIS) Multisonde Cleaning and Calibration application (**Figure 71**). Use the Fulcrum application to verify receiving stock solution, to track calibration solutions (dilutions), and to collect cleaning and calibration data.



Title: NEON Preventive Maintenance Procedure: AIS Surface Water Quality Multisonde		Date: 04/19/2022
NEON Doc. #: NEON.DOC.001569	Author: B. Nance, D. Monahan, M. Mahal, M. Cavileer	Revision: D



(AIS) Calibration Solution Tracking [PROD]

App for entering information about calibration solutions used in the field for the mutlisonde.

Last activity 1 day ago



NEON Multisonde Cleaning and Calibration [PROD]

Application for collecting multisonde cleaning and calibration data.

Last activity 3 days ago

Figure 71. Multisonde Fulcrum Applications

Select calibration solution dilutions by name (Figure 72) to reference their temperature correction tables during calibration using the NEON Multisonde Cleaning and Calibration [PROD] application.

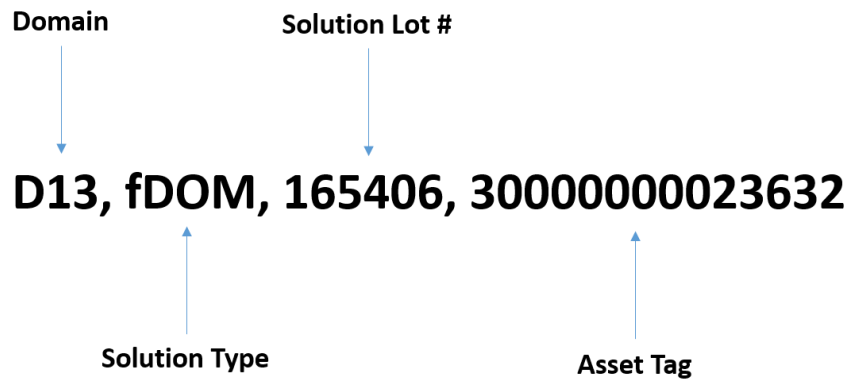

Figure 72. Solution Dilution File Name for Multisonde Cleaning and Calibration [PROD] Fulcrum Application

5.4.1.2.2 Calibration Solution Preparation: fDOM Sensor

Prepare a quinine sulfate calibration solution in the DSF Lab prior to heading out into the field to conduct calibrations on the fDOM probe sensor. Table 13 provides basic instructions on how to prepare this calibration solution dilution.



Table 13. Calibration Solution Preparation: fDOM Sensor

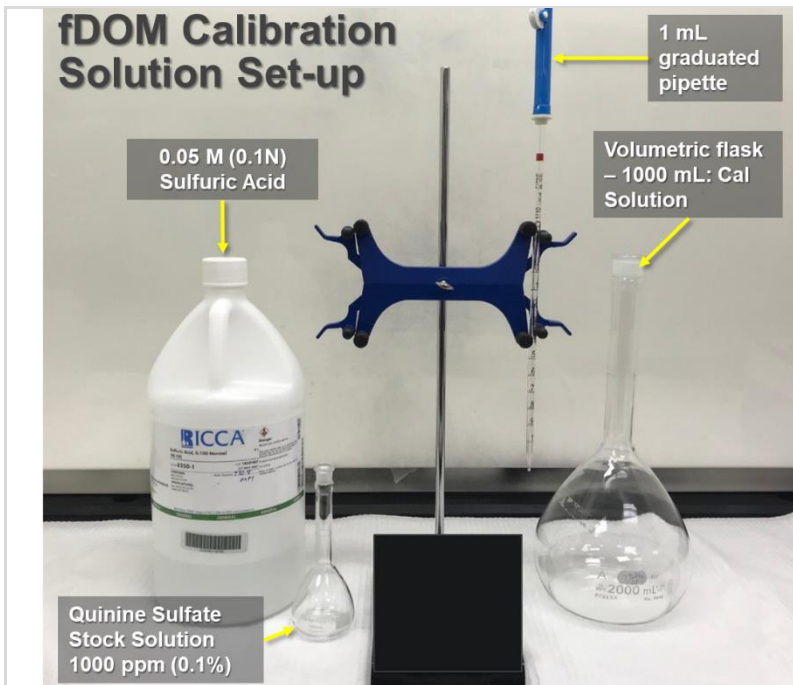

Figure 73. fDOM Calibration Solution Set-up

STEP 1 | In the DSF Lab, prepare the quinine sulfate calibration solution.

CVAL is providing a stock solution of 1000 mg/L quinine sulfate in 0.1 N H₂SO₄ to Field Science.

Set up the calibration solution materials and then fill half a 1000 mL volumetric flask with 0.1 N H₂SO₄ (**Figure 73**).

Wear the appropriate PPE and follow Domain Chemical Hygiene and Biosafety Manual protocols.

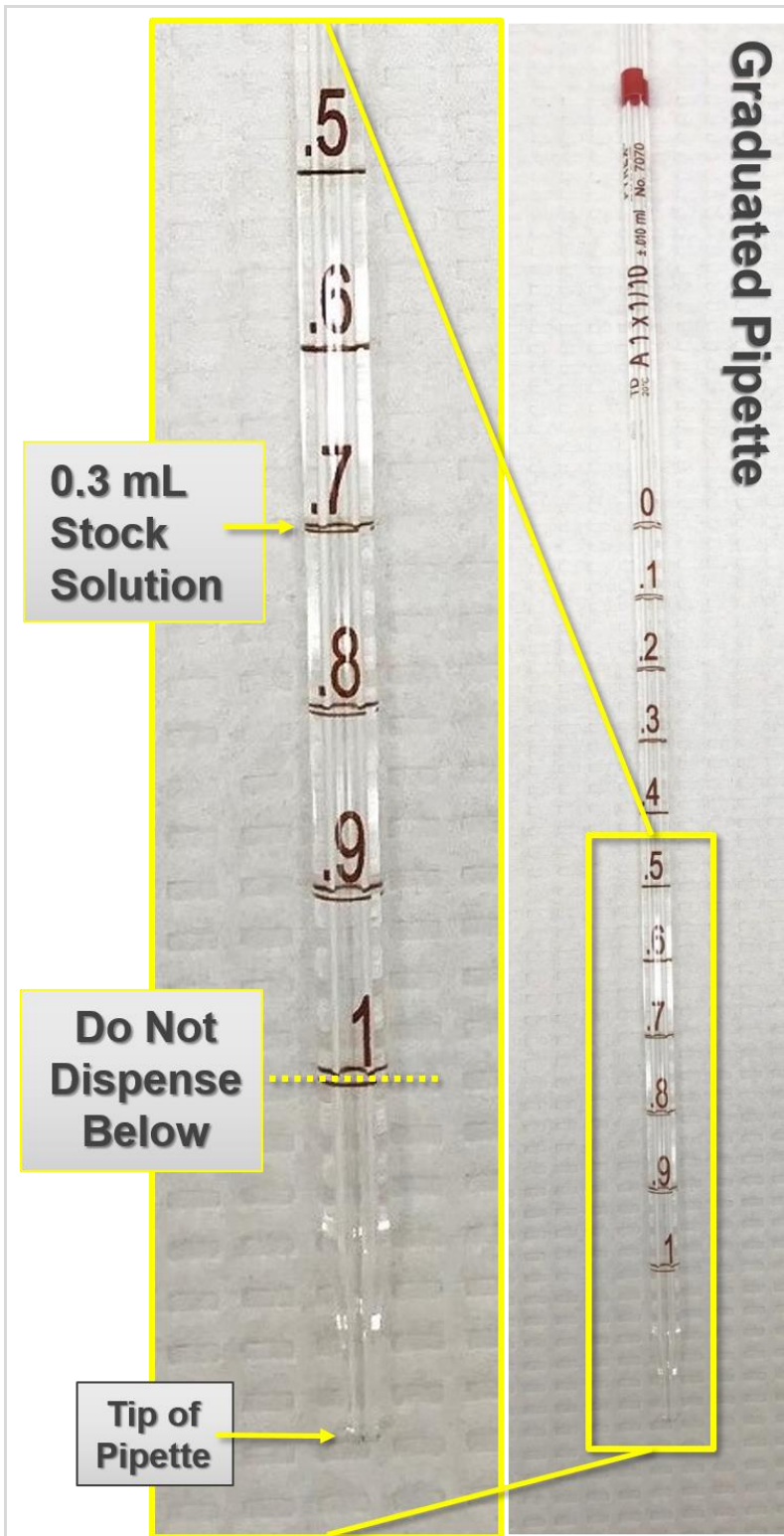

Figure 74. Graduated Pipette Use for fDOM Calibration Solution

STEP 2 | Prepare the 300 ug/L fDOM calibration solution. Fill the flask approximately half way with 0.1 N H₂SO₄. Dilute 0.3 mL of stock solution into the 1000 mL volumetric flask (**Figure 74**).

Transfer the 0.3 mL using a graduated 1 mL pipette.

When using the 1 mL pipette, do not dispense below the 1 mL line at the bottom. Measure the volume of liquid as a differential. For example. Fill to 0.7 mL and discharge to the 1 mL line. **Figure 108** illustrates this measurement. **Do not dispense volume below the 1 mL line of the graduated pipette.**

Note: Use the bottom of the meniscus for measuring liquid volumes.

Note: Use 0.6 mL of stock solution if preparing a 2 L calibration solution.

Field Science may prepare a 2 L solution, if more volume is required for calibration. Field science should use the same 1 mL pipette and use 0.6 mL measurements rather than two 0.3 aliquots. For example, for 600 ug/L, use 0.6 mL stock solution, but do not dispense below the 1 line.



Figure 75. Prepared fDOM Calibration Solution with Amber/HDPE Bottles

STEP 3 | For storage and when traveling to site, protect this solution from light by using an amber or HDPE bottle (Figure 75).

The diluted calibration solution expires after 5 days.

5.4.1.2.3 Calibration Solution Preparation: Total Algae/Chlorophyll Sensor

Prepare a Rhodamine WT calibration solution in the DSF Lab prior to heading out into the field to conduct calibrations on the Total Algae/Chlorophyll probe sensor. Table 14 provides basic instructions on how to prepare this calibration solution dilution.

Table 14. Calibration Solution Preparation: Total Algae/Chlorophyll Sensor

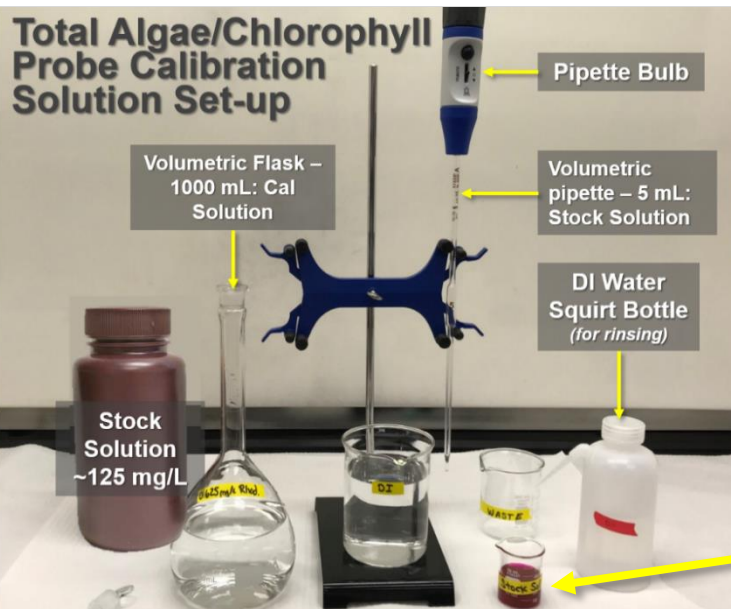

Figure 76. Total Algae/Chlorophyll Calibration Solution Preparation

STEP 1 | In the DSF Lab, prepare the Rhodamine WT calibration solution (dilution with DI water).

Set up the calibration solution materials and then fill half a 1000mL volumetric flask with DI water (Figure 76).

Wear the appropriate PPE and follow Domain Chemical Hygiene and Biosafety Manual protocols.

Note: Never place the pipette directly into the stock solution bottle. Always, pour a small amount of stock solution into a small beaker and pull from that aliquot.



STEP 2 | Pour a small amount of stock solution into a small beaker. Prime the pipette with stock solution first. Discard this solution into a waste beaker. Then transfer 5 mL of stock solution into the 1000 mL (1 Liter) flask using the primed volumetric pipette. Fill the pipette to the “TC” (To Contain) line. Dispense into the 1000 mL flask. Use a rinse bottle with fresh DI water to flush the remaining contents in the pipette into the flask. Fill the 1000 mL flask to volume with DI water (**Figure 77**). Gently invert the flask three times to mix the solution dilution (Rhodamine is more viscous than water).

 *Note: Use the bottom of the meniscus for measuring liquid volumes.*

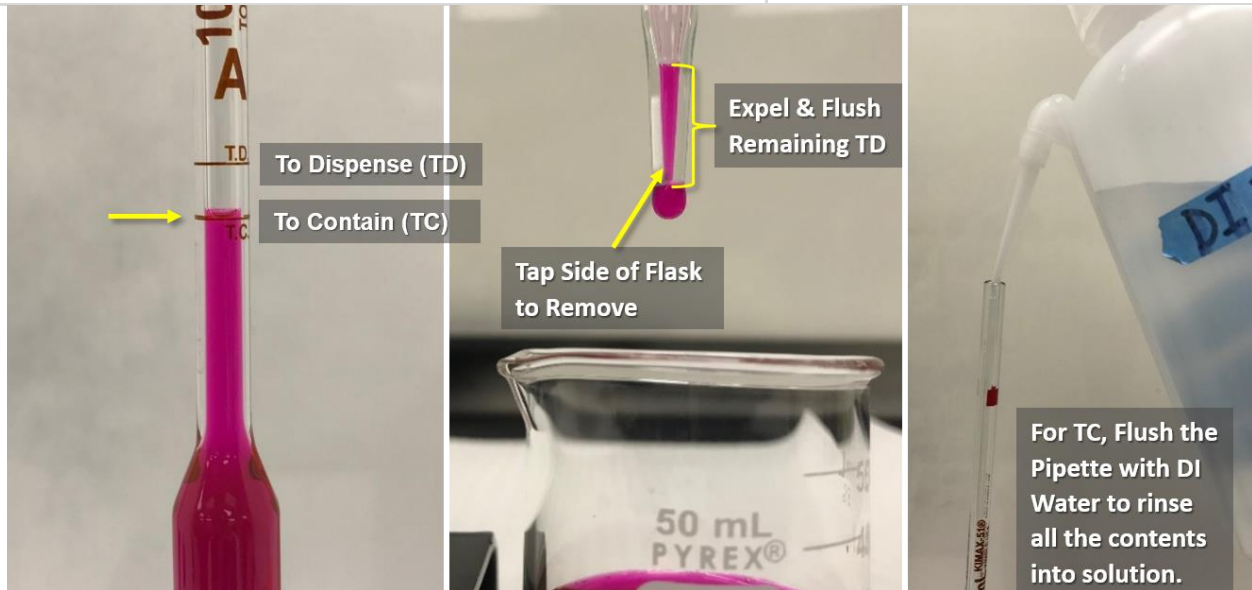

Figure 77. Dilute 5 mL of Stock Solution into 1000 mL Flask and Bring to Volume with DI Water

STEP 3 | A and B of **Figure 78** displays the creation of a 0.625 mg/L Rhodamine WT with DI water from CVAL provided stock solution. The solution is light sensitive. Protect it from light by either covering it in foil or by using an amber HDPE container (C and D in **Figure 78**), when storing or transporting the solution to site.

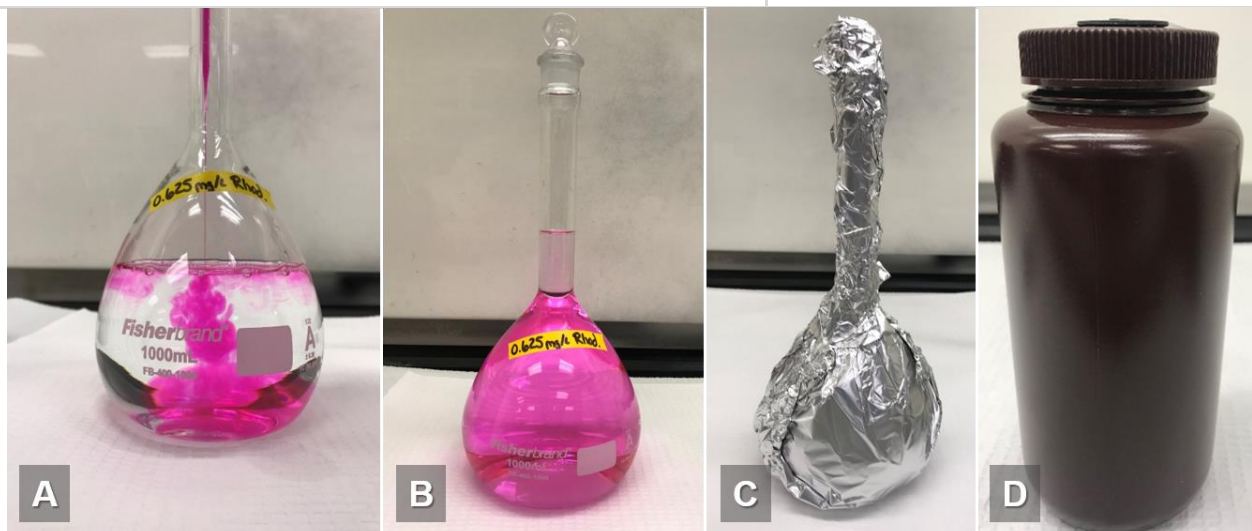

Figure 78. Prepare Total Algae/Chlorophyll Calibration Solution with Rhodamine WT and DI Water



The calibration solution expires after 24 hours.

5.4.1.3 Deionized (DI) Water Requirements

DI water must meet the following minimum requirements:

	Type I	Type II	Type III	Type IV
Electrical conductivity, max, $\mu\text{S}/\text{cm}$ at 298 K (25°C)	0.056	1.0	0.25	5.0
Electrical resistivity, min, M $\Omega\text{-cm}$ at 298 K (25°C)	18	1.0	4.0	0.2
pH at 298 K (25°C)	A	A	A	5.0 to 8.0
Total organic carbon (TOC), max, $\mu\text{g}/\text{L}$	50	50	200	no limit
Sodium, max, $\mu\text{g}/\text{L}$	1	5	10	50
Chlorides, max, $\mu\text{g}/\text{L}$	1	5	10	50
Total silica, max, $\mu\text{g}/\text{L}$	3	3	500	no limit

Figure 79. DI Water Minimum Requirements: ATSM Type II²

Poor quality, old, or improperly stored DI water can cause bad blank readings. The intent here is to have sterile, nitrate and organic-free blank water for maintenance of optical sensors. Therefore, Field Science must conduct the following procedure before heading into the field to calibrate Multisonde optical sensors.

1. Acquire fresh Milli-Q DI water from the domain support facility. The DI water is fresh if it was filtered with 24 hours to meet the minimum standard specification in **Figure 79**.
2. Seal/store DI water in a HDPE container (note that for the SUNA, you MUST use combusted glass or clean Teflon container – these containers are also acceptable for Multisonde calibration DI water source). DI water stored in plastic may have plastic molecules that have leached into the DI water that can absorb UV over the spectral range of the sensor, and will cause an incorrect reading.
3. Rinse bottles and caps with fresh Milli-Q DI water at least three (3) times before use.

5.4.2 Field Calibration Procedures

Calibrate Multisonde sensor probes according to guidance in Section 5.3.1, during Sensor Refresh, and/or post-corrective actions on the sensor (e.g., sensor was dry or not functioning correctly). After bi-

² The measurement of pH in Type I, II, and III reagent waters has been eliminated from this specification because these grades of water do not contain constituents in sufficient quantity to significantly alter the pH. Source: <https://www.astm.org/DATABASE.CART/HISTORICAL/D1193-99E1.htm>



Title: NEON Preventive Maintenance Procedure: AIS Surface Water Quality Multisonde		Date: 04/19/2022
NEON Doc. #: NEON.DOC.001569	Author: B. Nance, D. Monahan, M. Mahal, M. Cavileer	Revision: D

weekly maintenance is complete, calibrate the probes using the procedures in **Table 16**. This procedure requires the following equipment: a fully charged laptop with version 1.1.8 of the Kor software downloaded, USB signal output adapter cable to connect to the sensor, calibration solutions and DI water per Section 5.4.1.2.2, calibration cup, cleaning materials per Section 5.3.8, extra pair of D-Cell batteries, a bucket to catch solutions onsite for disposal elsewhere, 5-gallon bucket(s) to calibrate Multisonde(s), lint-free cloths to dry components in-between rinses, black plastic guard, a couple pairs of nitrile powder-free gloves, basic tools per Section 6.2.3 to remove the wiper brush, and a black plastic calibration guard.

5.4.2.1 Calibration Solutions: Field Equilibration Procedure

YSI EXO Multisonde has a built in temperature correction. However, the YSI Kor software requires Field Science to input a temperature corrected value for fDOM, Chlorophyll, and pH calibration solutions. For probe sensors that require multiple point calibrations, the temperature corrected value derives from the first-point calibration solution. To maintain consistent temperature values, Field Science must equilibrate all solutions. The calibration solutions for Chlorophyll, Conductivity and Temperature, fDOM, and Turbidity must equilibrate to ambient temperature. Calibrate DO using water saturated air, which is equilibrated for 15 in its calibration cup. Equilibrate pH solutions to stream temperatures. The NEON program equilibrates these two probe sensors to stream temperature as a redundancy. Instructions for both methods are below in **Table 15**.

Table 15. Ambient Air and Stream Temperature Equilibrium Guidance

Ambient Air Temperature Equilibration <i>(Chlorophyll, Conductivity and Temperature, fDOM, Turbidity & DO)</i>	Stream Temperature Equilibration (pH)
<p>A. When packing solutions: DI and standard, try to store in bottles so that the volume is roughly the same this will allow greater time to equilibrate to the sites ambient air temperature.</p> <p>B. When on site, let solutions sit for <u>30-60 minutes</u> in the shade. This timeframe allows the solutions to equilibrate with the surrounding ambient air temperature. The aim is to equilibrate each solution at the same ambient air temperature.</p> <p>C. For DO equilibrium: Pour approximately 1 cm of DI water into the calibration cup and allow it to sit for 15 minutes.</p>	<p>A. Submerge a wash bottle full of DI water and pH calibration buffer solutions directly into the surrounding body of water. Be sure the wash bottle is secure and will remain in place, submerged without contamination for 30-60 minutes. The temperature of the DI water/buffer solutions must reach the same temperature as the body of water of the Multisonde location onsite.</p> <p>B. Alternatively, use a five-gallon bucket or dairy crate to equilibrate to the site’s ambient water temperature (Figure 80) with the following procedure.</p> <p>C. Section 5.4.2.1.1 below provides procedural details for this method.</p>



5.4.2.1.1 Stream Temperature Equilibration Procedure (pH only)

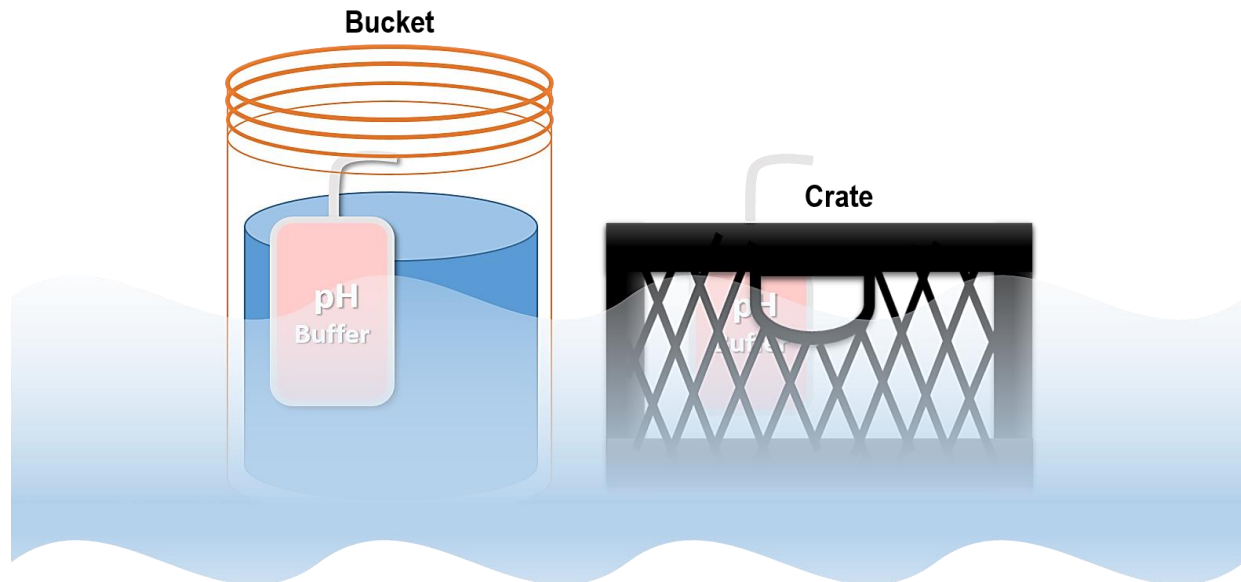

Figure 80. Alternate Setups for pH and DI Water Temperature Equilibration

1. Place approximately 18 inches of water from the site (e.g., stream, river or lake) into a 5-gallon bucket or skip this step and use a dairy crate.
2. Place the bucket or crate in the water. Ensure it is secure and will not float away. HQ recommends using a dairy crate since it allows the water flow through, instead of around, which results in achieving equilibrium more quickly.
3. Place wash bottle of DI water and buffer solutions into water bath.
4. Let stand at least **30-60 minutes** for the temperature of the DI water and buffer solutions to reach the same temperature as the environment. After ~30-60 minutes, the assumption is the DI water and buffer solutions are at ambient stream/lake/river temperature. If not, due to extreme heat temperatures and the bucket in direct sunlight, exchange the water in the bucket for fresh water and continue waiting until the DI water/buffer solutions are at ambient water temperature.

5.4.2.2 Field Calibration and Validations Procedures

Table 16 provides an instructional overview of steps and best practices Field Science must be aware of when calibrating the Multisonde sensor probes. After this section, information to calibrate each probe sensor is under its respective section title, which includes sensor-specific solution preparation information. **Read this section in its entirety before traveling to an AIS site to conduct calibrations.** See *Section 5.4.2.10 for the criteria that determines if a calibration is a success or failure.*



Note: If the solutions are freezing during the validation or calibration process, or Technicians are unable to access the Multisonde due to ice/unsafe working conditions, do not continue preventive maintenance/validations/calibrations.

Table 16. Field Calibration/Validation Procedure

STEP 1 | IMPORTANT: Verify calibration solutions are not expired. Expired calibration solutions cannot be used for sensor probe calibrations.

In addition, it is assumed the sensor probes are clean from the previous procedure in Section 5.3.9 and 5.3.10, **Table 10**. Dirty equipment contaminates calibration solutions.

STEP 2 | Immediately upon arrival onsite, place a milk crate with the pH buffer solutions and DI water into the stream or submerge the solutions in a bucket of stream/river water.

This allows the solutions to equilibrate while conducting other site maintenance and when conducting pre- and post- cleaning procedures/readings.



Figure 81. Remove Central Wiper Brush

STEP 3 | It is assumed that the brush was removed during the cleaning process. If not, remove the central wiper brush and clean the area around and under where the brush was installed. (Biofouling may accumulate under the brush over time.) Additionally, the copper in the assembly degrades the fDOM calibration solution (quinine sulfate solution) within minutes.

Use a 0.050-inch Allen wrench to remove the setscrew securing brush to the wiper assembly (**Figure 81**). (Acidic calibration solutions eat away at the bristles and may add contaminants into the solutions during calibrations.)

See Section 6.2.3 for additional information on how to remove the central wiper brush and/or assembly.



STEP 4 | Triple rinse the sensor probe(s), the black calibration guard, and the calibration cup with DI water before running and between probe sensor calibrations (**Figure 82**). Triple rinse with the solution or buffer before calibrating to that buffer or solution during the calibration of a sensor probe. The purpose of rinsing the Multisonde is to remove or dilute all fluid in the sensor that may affect calibration.

1. Fill the calibration cup with DI or calibration solution halfway to the first fill line.
2. Install the calibration/storage cup; screw the collar tight enough to ensure it does not leak. *(For optical sensors, use the black calibration guard before installing the calibration/storage cup.)*
3. Shake the Multisonde for ~15 seconds, rinsing all sensors and crevices on the sensor head. **Use this method for all sensors with the exception of Turbidity. DO NOT SHAKE TURBIDITY CAL SOLUTIONS.** It causes bubbles/aeration, which affects the calibration process.
4. Discard the rinse solution.
5. Fill the calibration cup again (halfway to the first fill line), and rinse and repeat two more times.



Figure 82. Triple Rinse Sensors & Calibration Cup with DI Water (Source: [ER \[08\]](#) Slide 10)

The triple rinse procedure is a vital step in performing an accurate calibration; it ensures that once the sensor is in the calibration cup, it is measuring from the solution, buffer, or blank reading from the sensors. Capture all solution and standards used for calibration and rinsing in a separate container and dispose of the fluid per Domain protocols, in accordance with local, state, and tribal laws.

Do not set any of the probes on the ground or in a dirty area or they require additional rinsing. Do not reuse DI water that was already used to rinse a sensor.

Do not shortcut or ignore this step for sensor probe calibrations; skimping on rinsing may negatively influence calibration values. Rinse 3x in-between each sensor probe calibration with DI water or expired calibration solution used to calibrate the next sensor!



Figure 83. Multisonde Black Plastic Guard for Calibration of Optical Sensors

STEP 5 | OPTICAL SENSORS ONLY:

Install the black calibration guard (Figure 83) to calibrate the Multisonde’s optical sensors: Chlorophyll, fDOM, DO, and Turbidity.

Ensure the guard is clean to prevent it from influencing the calibration results.

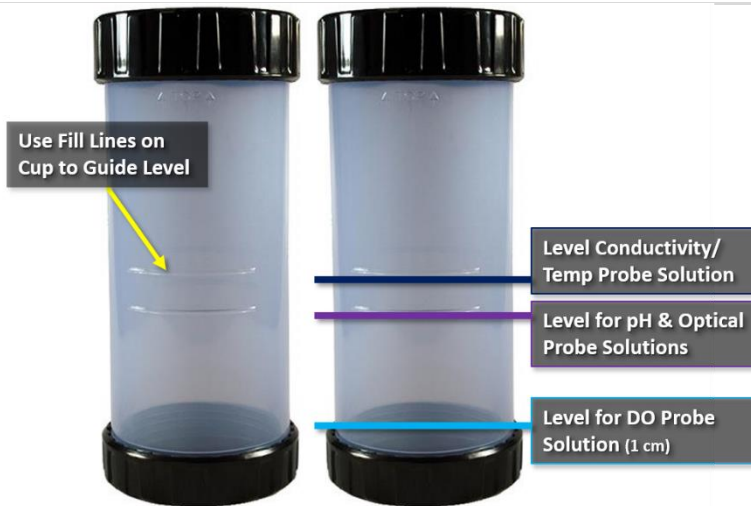

Figure 84. Amount of Calibration Solution to Use for each Sensor Probe

STEP 6 | Install the calibration cup with the calibration solution required to calibrate the sensor probe.

For Optical (except DO) and pH probes, fill to the first line in the calibration cup for each solution. For the C/T probe, fill to the second line. The DO probe requires “water saturated air”. The solution should not touch the probe. **Figure 84** provides an overview of each fill line for calibrations.

A subsection for each sensor probe, their calibration requirements, and process using the software, proceed after these generic instructions in this table.

STEP 7 | For sites with two Multisondes that collect measurements in the same body of water: these sites must conduct a bucket test to validate the calibration to determine if it is successful. To conduct this test, fill 1/4 - 1/3 of a 5-gallon bucket with stream water (river water for FLNT) and place both



Multisondes in the bucket at the same time. If the water is sitting in the bucket for a long duration, replace it with fresh stream/river water. Sites with one Multisonde do not require a bucket test.

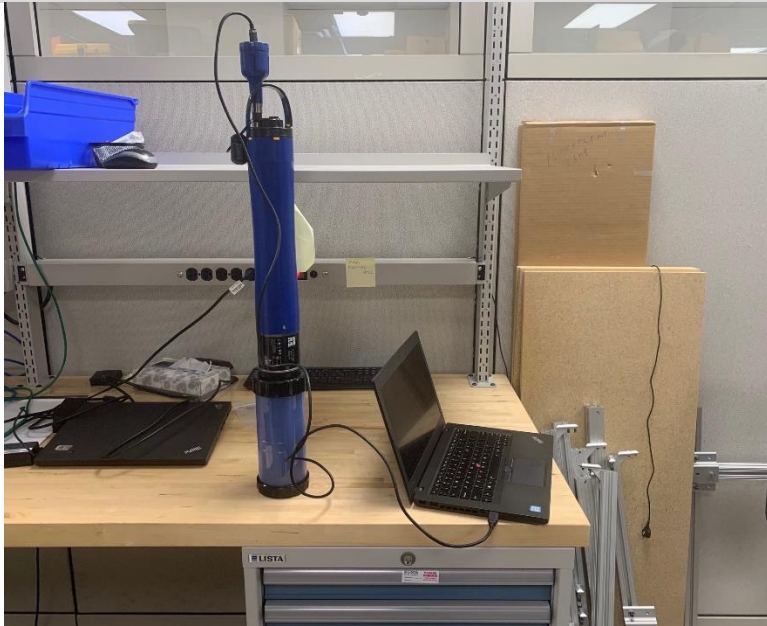

Figure 85. Connect to the Multisonde

STEP 8 | Connect to the Multisonde per Section 5.3.8.

Skip this step if you are already set up.

Figure 85 is an example of connecting to the Multisonde through USB connection.

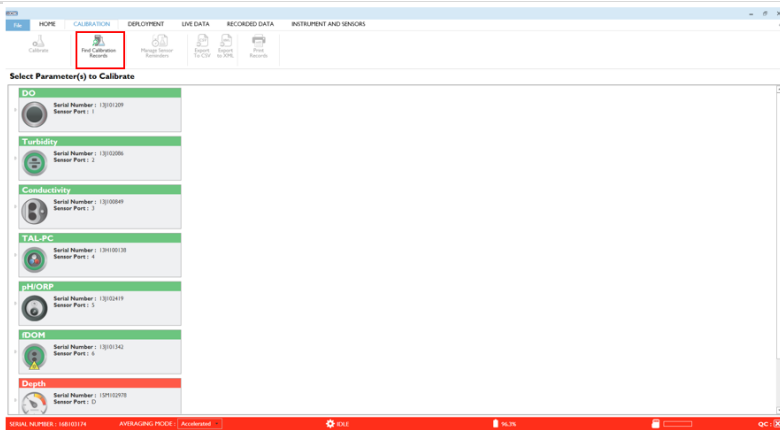

Figure 86. Navigate to calibration menu.

STEP 9 | Open the Kor software.

In the Kor software, select the calibration icon in the top banner (**Figure 86**).

The software lists each port with their associated sensor in a column on the left-hand side of the screen capture in **Figure 86**.

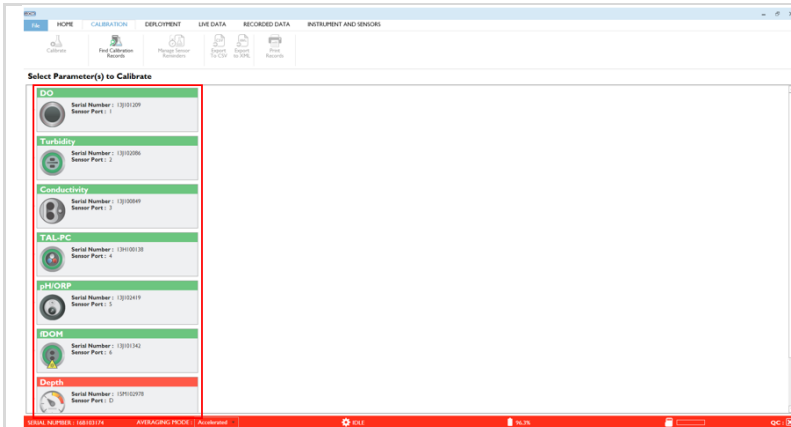

Figure 87. Select parameters for calibration.

STEP 10 | Select Under the Calibration section, it lists each sensor probe on the left of the screen (**Figure 87**).

AIS Science recommends calibrating the sensor probes in the following order:

1. Conductivity/Temperature
2. Turbidity
3. Chlorophyll (Chla)
4. fDOM
5. pH/ORP
6. DO

Conductivity must always occur before pH.

Important Rules and Best Practices:

- Due to the pH solutions high conductance, Field Science must calibrate the Conductivity/Temp before the pH probe sensor.
- Use the black guard to calibrate optical sensors: fDOM, DO, Turbidity, chlorophyll.
- AIS Wadeable stream sites do not calibrate the depth sensor. AIS Buoy sites must calibrate the depth sensor (this is not applicable to FLNT or single stream sites, such as BLUE).
- The bucket test is applicable to wadeable stream sites and the D03 FLNT buoy because these are sites with two Multisondes to allow AIS Science staff to compare calibration data.
- Chlorophyll, fDOM, Turbidity, DO and pH requires an input for temperature corrections.
 - pH requires stream water equilibrium.
 - Chlorophyll, fDOM, and Turbidity require ambient air equilibrium. The objective is to allow the DI water and calibration solution temperatures to stabilize and synchronize temperatures as much as possible.
 - DO requires water-saturated air equilibrium – allow the DI water to humidify the calibration cup by letting it sit in the calibration cup for at least 15 minutes before calibrating. Do not screw on the calibration cup tightly; a quarter turn of the calibration cup should allow for barometric pressure equilibration.
- Use a milk crate to equilibrate and maintain pH buffer solutions at stream temperature. Milk crate is easy to secure with a string to shore and maintain the solutions without floating downstream.
- Use the Fulcrum Calibration and Cleaning Solutions application to calculate temperature corrected values.
- Each calibration requires entering solution lot numbers, ensure these are available and correct.
- Do not forget to triple rinse in-between sensor calibrations.



Title: NEON Preventive Maintenance Procedure: AIS Surface Water Quality Multisonde		Date: 04/19/2022
NEON Doc. #: NEON.DOC.001569	Author: B. Nance, D. Monahan, M. Mahal, M. Cavileer	Revision: D

- It is OK to use buffer solutions to rinse the pH sensor in the order of 7, 10 and 4. Seven must be first.
- Cease calibrations if the solutions are freezing during the calibration. Submit a ticket to report the missed PM bout in the NEON Program’s Issue Management and Reporting System to ensure AIS Science staff are aware for data quality purposes.
- Domain 11 recommends packing a bus tub bin for catching spills, a funnel with a waste container (an old solutions utility gallon jug suffices), a couple buckets to place the Multisondes in (if calibrating both Multisondes at the same time), and two extra buckets to use as a chair and desk.
- Have hardcopies of the calibration procedure and Grape Port Mapping handy. Ensure hard copies are from the latest version via the Document Warehouse.
- Bring extra D Cell batteries to address any sensor calibration issues caused by low battery power.
- If the first sensor calibration fails, you must attempt at least two more calibration on that sensor before considering the sensor to have failed. If the sensor fails three (3) calibration attempts, the sensor requires corrective action.
- Upload Calibration Files to CVAL using the IS Control and Monitoring Suite. Reference Section 8.



STEP 11 | Apply powder-free nitrile rubber gloves to handle the sensor probes without contaminating the calibration process from dirt/oils on our hands. If the rubber gloves are dirty, replace them with a fresh pair to prevent influencing probe calibrations.

RINSE SENSOR PROBES 3X WITH DI TO PREPARE FOR CALIBRATION.

5.4.2.3 Field Calibration Procedure: Conductivity

Ensure the conductivity sensor is clean before conducting calibrations (reference Section 5.3.10.4).



Figure 88. Bryce Nance is Gently Rotating the Multisonde to Remove Bubbles

STEP 1 | After triple rinsing the sensor and calibration cup, calibrate the Conductivity and Temperature sensor probe.

Pour the conductivity standard into a clean and dry or pre-rinsed EXO calibration cup. Calibration for this probe requires 1000 $\mu\text{S}/\text{cm} \pm 0.50\%$ solution from an unopened YSI 500ml bottle. Do not use any solution from a previously opened bottle.

Fill the calibration cup up to the second marked line to ensure the standard is above the vent holes on the conductivity sensor (**Figure 84**).

Immerse the probe end of the Multisonde into the solution, and gently rotate and/or move the Multisonde up and down to remove any bubbles from the conductivity cell (**Figure 88**).

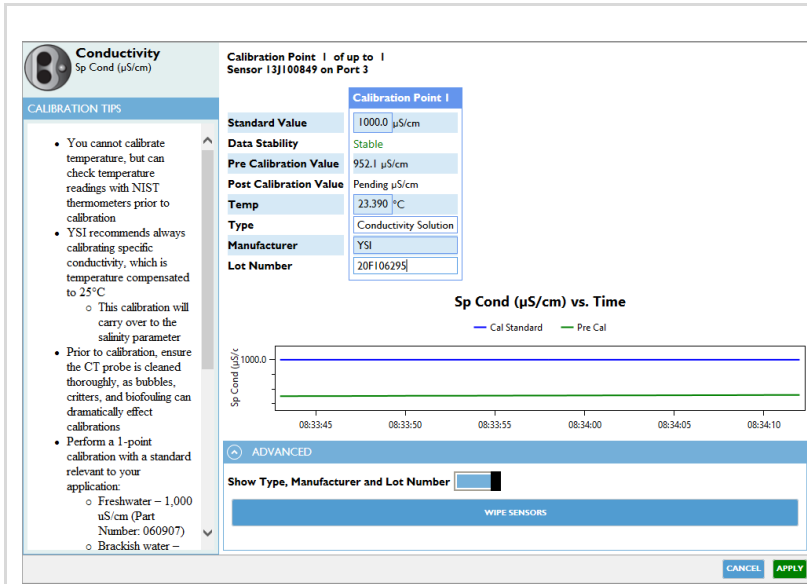

Figure 89. Input data in editable fields.

STEP 2 | Open the Kor software.

Select the probe and correct units ((Sp Cond (µS/cm)) under the Calibration Menu. Input the following information for a one-point calibration:

- Enter Standard Value: 1000.00
- Enter Type: Conductivity Solution
- Enter Manufacturer: YSI
- Enter Solution Lot Number
- Enter temperature

While inputting data, standard is automatically stabilizing.

Note: If the data does not stabilize after 40 seconds, gently rotate the Multisonde or remove/reinstall the calibration cup to make sure there are no air bubbles in the conductivity cell.

STEP 3 | Observe the pre calibration value readings and the data stability. When the calibration window states “Stable”, click “Apply” (Figure 90) in the bottom right of the **Device Calibration** window to accept this calibration point.

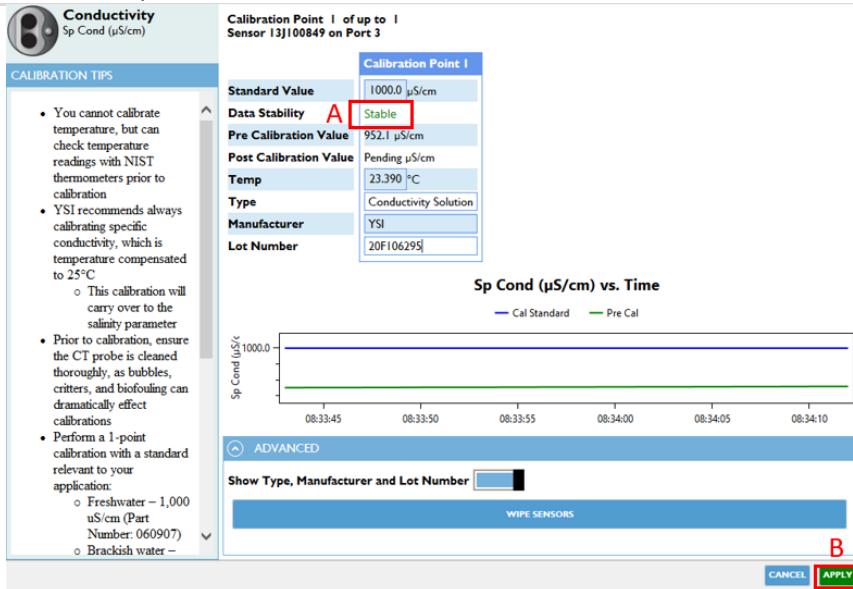

Figure 90. Wait for stable data before applying.

STEP 4 | View the **Calibration**

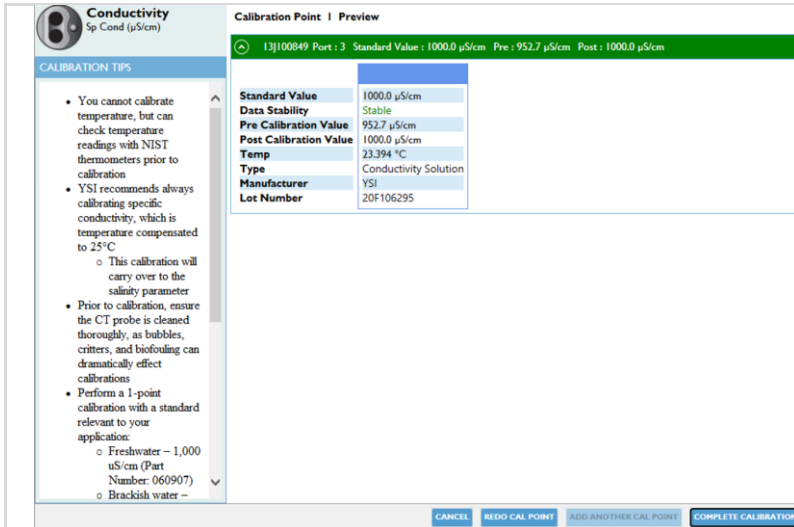



Figure 91. Successful calibration summary page.

Summary for Cal Point 1 to determine if the calibration was successful. The QC score informs the pass/fail status for the field calibration. A passing calibration results in a green bar as shown in **Figure 91**.

 *Note: If calibration results in a red QC score, CVAL sets a suspect calibration flag when ingesting Multisonde calibration files. A suspect calibration generally means the calibration result is a failure. If the sensor fails again, conduct a factory reset and re-calibrate the sensor two more times to verify the results are accurate.*

Click **“Complete Calibration”** to return to the sensor Calibration Menu.

RINSE SENSOR PROBES 3X WITH DI TO PREPARE FOR NEXT CALIBRATION.

5.4.2.4 Field Calibration Procedure: Turbidity

Ensure the turbidity sensor is clean before conducting calibrations (reference Section 5.3.10.1).

STEP 1 | Calibrate the turbidity sensor probe. Use a black guard to calibrate this sensor. This calibration point varies across sites: Lakes conduct a 2-point calibration, with the exception of TOOL. Streams, rivers and TOOL conduct a 3-point calibration. Submit an incident ticket if there are site-specific reasons to change to either a 2-point calibration for streams/river sites, 3-point calibration for lake sites, or upon AIS Science direction.



Figure 92. Pour Solution at an Angle to Decrease Aeration

STEP 2 | Pour in the DI Water into a clean, pre-rinsed calibration cup to immerse the probe end.

Tilt the calibration cup and pour the solution at a 45° angle slowly to decrease aeration (Figure 92).

Fill the calibration cup up to the first marked line. Triple rinse sensors between each calibration point.

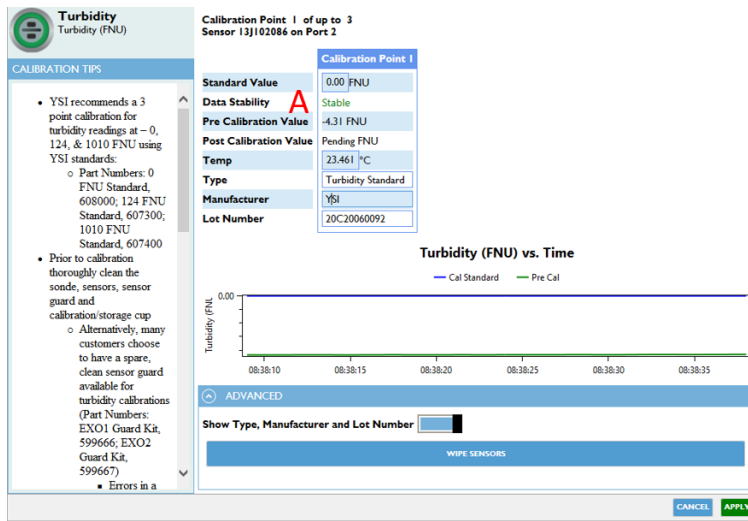

Figure 93. First calibration point.

STEP 3 | In the Kor software, select the port with the Turbidity sensor probe in the Calibration Menu. Select **Turbidity FNU** units. Next, in the **Device Calibration** window, input the following information:

- Enter Standard Value or 0.0 for the first calibration point
- Enter Temperature of solution
- Enter Type [DI water]
- Enter Manufacturer
- Enter Solution Lot Number

While entering values, probes will begin stabilizing. Wait until data is stable [A in **Figure 93**].

Note: Pay careful attention while submersing the sensor for bubbles on the face of the turbidity sensor. Do not trap bubbles on the sensing area of this probe sensor. Gently tap the calibration cup with hand to dislodge trapped bubbles.

STEP 4 | When the data are stable, click “Apply” to accept this calibration point (**Figure 93**).

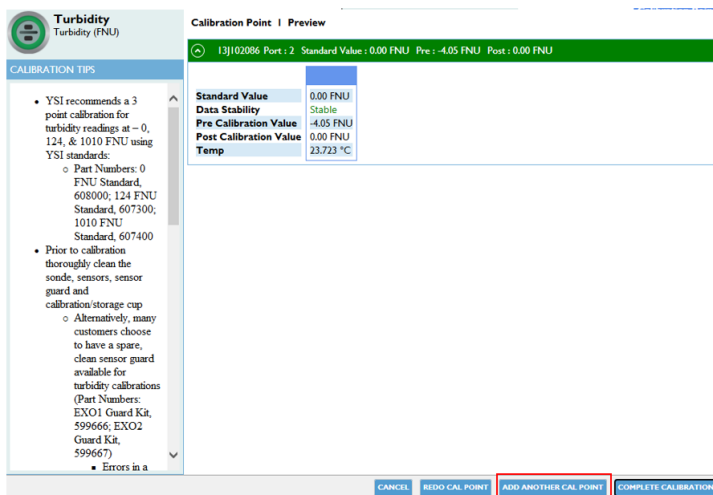

Figure 94. Continue adding calibration points.

STEP 5 | Click on “Add Another Cal Point” (**Figure 94**) in the lower right corner of the **Device Calibrations** window to move to the next calibration point.

This will take you to a new calibration screen. Enter the data for next calibration point as shown in **Figure 93**.

Note: While temperature input is required, turbidity is not temperature dependent. Use 124FNU for a 2-point and 1010FNU for a 3-point.

Site type determines between 2 and 3 point calibrations:



- Lake/River buoy calibrate 2 point
- Stream sites calibrate 3 points

STEP 6 | Triple rinse the sensors, Multisonde guard and calibration cup with a small amount of the turbidity standard for the second calibration point. **Do not shake the solution or Multisonde; it aerates the solution, which affects the calibration.** Discard this rinse in a waste bucket and fill the cup with the second calibration standard. Click “OK” to proceed to the next calibration point.

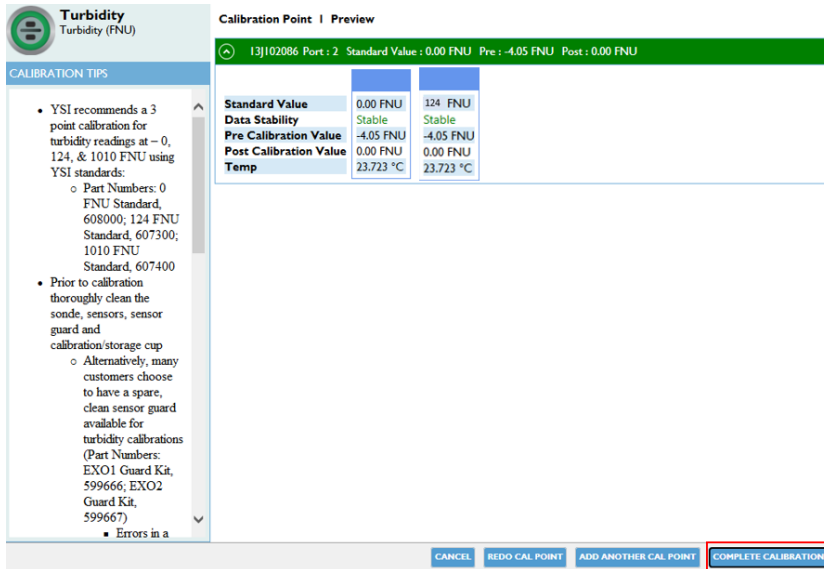

Figure 95. "Complete Calibration" once appropriate number of points complete.

STEP 7 | Again, wait until the window states Stable Data to click “Apply” and follow the guidance below that is applicable to your site.

FOR 2-POINT CALIBRATIONS: Click “Complete” to complete a 2-point calibration.

FOR 3-POINT CALIBRATIONS: Triple rinse the sensor probes. Then click “Add Another Cal Point” to calibrate the sensor using the 1010 FNU Turbidity Standard.

STEP 8 | Rinse the sensors, Multisonde guard and calibration cup with a small amount of the turbidity standard for the third calibration point. **Do not shake the solution or Multisonde; it aerates the solution, which affects the calibration.** Discard this rinse in a waste bucket and fill the cup with the third calibration standard.

STEP 9 | For the final calibration point, when the data is Stable, click “Apply”, and then click “Complete Calibration”. The **Device Calibration** window will provide a Calibration Summary. The color of the border informs the pass/fail status for the field calibration. A passing calibration results in a green bar. See Section 5.4.2.10 for more information on the field calibration pass/fail criteria.



Note: If calibration results in a red bar, CVAL sets a suspect calibration flag when ingesting Multisonde calibration files. A suspect calibration generally means the calibration result is a failure. If the sensor fails again, conduct a factory reset and re-calibrate the sensor two more times to verify the results are accurate.

STEP 10 | Click “Exit” to return to the sensor calibration Menu. **Discard all used Turbidity standards.**

RINSE SENSOR PROBES 3X WITH DI TO PREPARE FOR NEXT CALIBRATION.



5.4.2.5 Field Calibration Procedure: Chlorophyll (TAL-PC) (Buoy Only)

Ensure the Chlorophyll sensor is clean before conducting calibrations (reference Section 5.3.10.1).

STEP 1 | Calibrate both channels of the Chlorophyll sensor probe. Use the black guard to calibrate this optical sensor. Fill the calibration cup to the first fill line with DI water (0 µg chlorophyll/L).

(AIS) Multisonde Cleaning and Calibration [PROD] (editing)

ARIK, April 8, 2019 / Chlorophyll

Select Chlorophyll Solution: D10, chla, February 13, 2019, 165384, 30000000023717

Chla Dilution ID: D10|D13.chla.20190408

Chla Solution Temp (C): 20.2

Chla Temp Corrected Value: 68.16138

S1/buoy Chlorophyll (or FLNT Pump)

S1 Chlorophyll calibration required?

S2 Chlorophyll (or FLNT Standpipe)

S2 Chlorophyll calibration required?

Chlorophyll Comparison

This section will calculate additional information based on comparisons of S1 and S2 post-calibration values across the two multisondes. If calibrations are not required based on table 4, this section will compare the post-cleaning readings.

S1 Chlorophyll Bucket: 2.02

S2 Chlorophyll Bucket: 3.51

Chlorophyll Comparison Successful?: comparison unsuccessful

Readings do not match within threshold. Please recalibrate both sensors and enter new post-calibration readings below.

S1 Second chlorophyll measurement in bucket:

S2 Second chlorophyll measurement in bucket:

Figure 96. Calibration Solution Application in Fulcrum

This sensor requires temperature correction for both parameters.

In the Fulcrum Application, under the chlorophyll calibration record, there is a field for solution temperature. Fill this out once the second calibration point has been started. This will insure the most accurate temperature reading.

KOR v2

HOME | CALIBRATION | DEPLOYMENT | LIVE DATA | RECORDED DATA | INSTRUMENT AND SENSORS

Select Parameter(s) to Calibrate

- Turbidity (Serial Number: 13102086, Sensor Port: 2)
- Conductivity (Serial Number: 13100949, Sensor Port: 3)
- TAL-PC** (Serial Number: 13100138, Sensor Port: 4)
- pH/ORP (Serial Number: 13102419, Sensor Port: 5)
- IDOM (Serial Number: 13101342, Sensor Port: 6)
- Depth (Serial Number: 13102928)

PARAMETER TYPE LAST CALIBRATION DATE

Chlorophyll (RFU)	-factory Calibration	CALIBRATE	FACTORY RESET CALIBRATION
Phycocyanin (RFU)	-factory Calibration	CALIBRATE	FACTORY RESET CALIBRATION

SERIAL NUMBER: 16810174 | AVERAGING MODE: Accelerated | IDLE | BLN

Figure 97. Kor v2 has two values to calibrate.

STEP 2 | In the Kor software, select the port with the Chlorophyll sensor probe in the Calibration Menu.

Technicians will be calibrating both TAL-PC data streams:

- Chlorophyll (RFU)
- Chlorophyll (ug/L)

Pro-tip: If using a computer for the first time, you will need to configure the software. Select "File"; "Settings"; "Chlorophyll"; turn On RFU and ug/L.

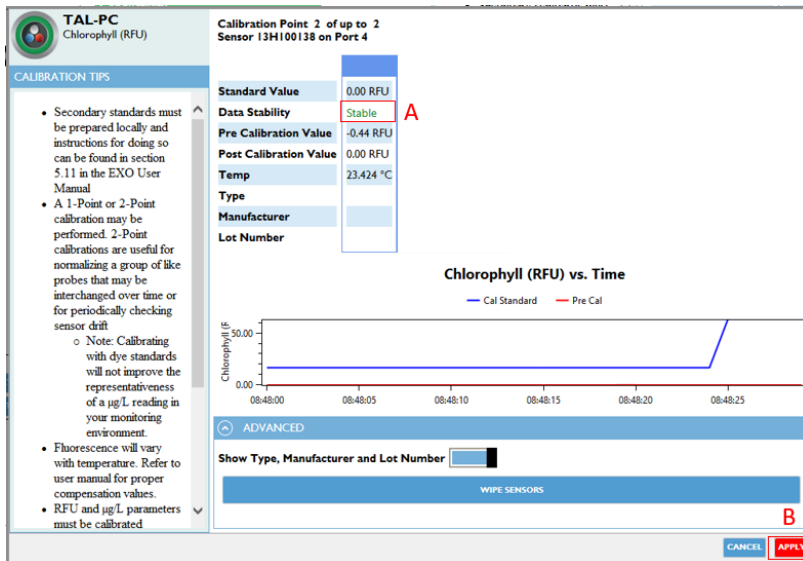

Figure 98. Enter values in software.

STEP 3 | In the **Device Calibration** window, input the following information for a 2-point calibration process (A in **Figure 98**):

- Enter Standard Value: 0.
- Enter Type: Pure Water (DI Water)
- Enter Manufacturer: Domain and CVAL
- Enter Lot Number: Blank for DI Water and use the Cal ID for Rhodamine

STEP 4 | When the window displays Stable Data in green (A in **Figure 98**), select the option to “**Apply**” (B in **Figure 98**)

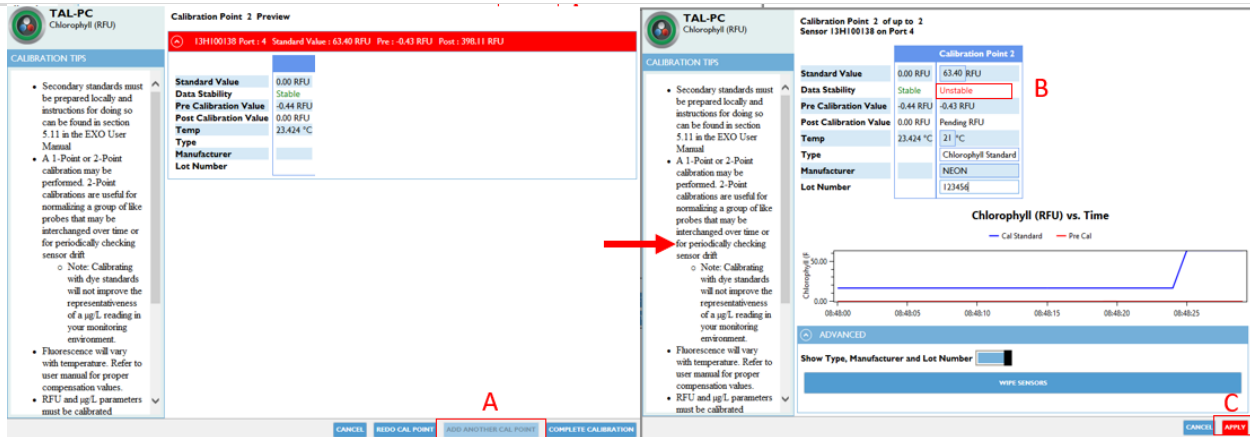



Figure 99. Complete first calibration point and then proceed to second.

STEP 5 | Triple rinse the sensors, Multisonde guard and calibration cup with a small amount of the standard for the second calibration point. Discard this rinse, and then fill the cup to the first fill line with the second point solution, Chlorophyll calibration standard: ~66 µg/L Rhodamine WT calibration solution. (This value varies across sites since it is based upon the stock solution and temperature correction.)

STEP 6 | In the second TAL-PC calibration point screen, enter the required information as well as the temperature corrected value.



Title: NEON Preventive Maintenance Procedure: AIS Surface Water Quality Multisonde		Date: 04/19/2022
NEON Doc. #: NEON.DOC.001569	Author: B. Nance, D. Monahan, M. Mahal, M. Cavileer	Revision: D

 *Note: **63.40 ug/L is a site-specific value (in Figure 99).** The next standard for the second calibration point uses a temperature corrected value. These values are site-specific. Determine these values in the Cleaning and Calibration Solution Fulcrum Application. If Fulcrum is unavailable, determine the temperature correction manually by referencing the label on the stock solution bottle.*

STEP 7 | When the window displays Stable Data in green, select the option to “**Apply**” (C in **Figure 99**). Then click “**Complete Calibration**” (**Figure 95**) to return to the calibration menu.

STEP 8 | Repeat **Step 1 to Step 7** for the **Chlorophyll (ug/L)** calibration parameter.

Discard all used Chlorophyll standards.

 *Note: If calibration results in a red bar, CVAL sets a suspect calibration flag when ingesting Multisonde calibration files. A suspect calibration generally means the calibration result is a failure. If the sensor fails again, conduct a factory reset and re-calibrate the sensor two more times to verify the results are accurate*

RINSE SENSOR PROBES 3X WITH DI TO PREPARE FOR NEXT CALIBRATION.



5.4.2.6 Field Calibration Procedure: Fluorescent Dissolved Organic Matter (fDOM)

Ensure the fDOM sensor is clean and rinsed with DI before conducting calibrations (reference Section 5.3.10.1).

STEP 1 | Calibrate the fDOM sensor probe onsite. Use the black guard to calibrate this optical sensor.

IMPORTANT: Ensure the wiper has been removed from the Multisonde. The copper in the assembly degrades the quinine sulfate standard solution within minutes.

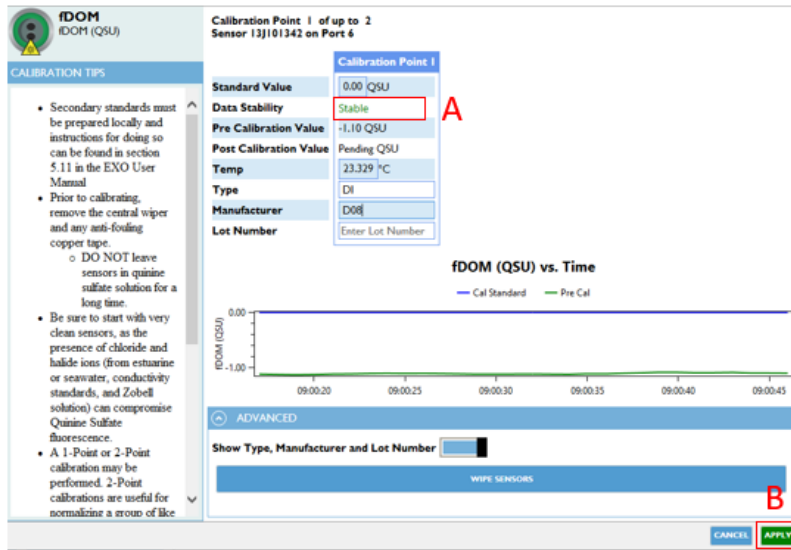

Figure 100. Enter values for first calibration point.

STEP 2 | In the Kor software, select the port with the fDOM sensor probe in the Calibration Menu. Input the following information for the first point of a two-point calibration:

- Enter Standard Value: 0.00
- Enter Type: Pure Water (DI Water) and Quinine Sulfate
- Enter Manufacturer: CVAL
- Enter Solution Lot Number: Use Cal ID for QS solution

Wait for stable values (A in Figure 100) and then press “Apply” (B in Figure 100) to continue to second point.

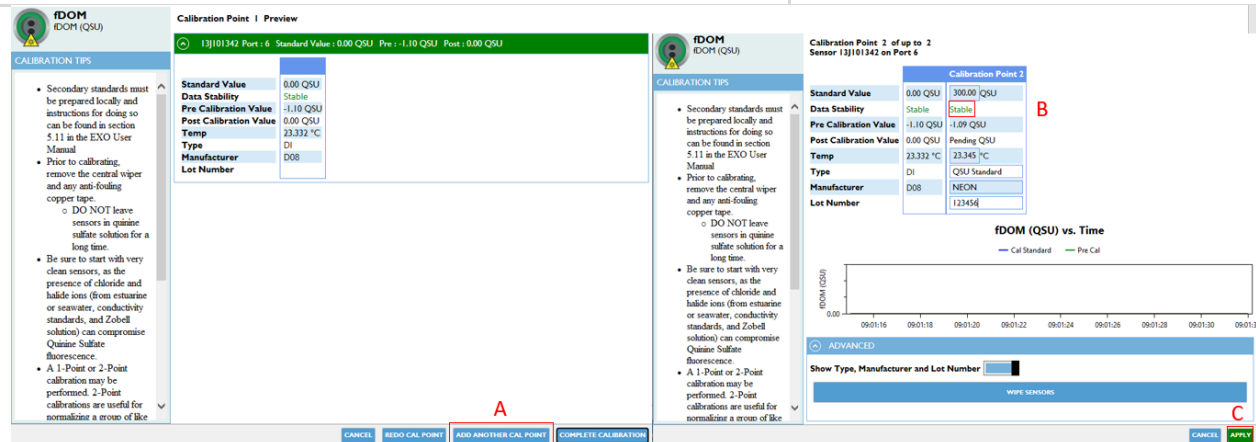

Figure 101. Proceed to second calibration point.

STEP 4 | Triple rinse the sensor with the standard calibration solution (before proceeding).



Title: NEON Preventive Maintenance Procedure: AIS Surface Water Quality Multisonde		Date: 04/19/2022
NEON Doc. #: NEON.DOC.001569	Author: B. Nance, D. Monahan, M. Mahal, M. Cavileer	Revision: D

STEP 5 | In the new window, click **“Add Another Calibration Point”** (A in **Figure 101**), to proceed to the next solution in the second calibration point. Once data is stable (B in **Figure 101**), hit **“Apply”** (C in **Figure 101**) to complete calibration.

STEP 6 | Review the Calibration Summary data to determine if the sensor passes/fails calibration. The QC score informs the pass/fail status for the field calibration. A passing calibration results in a green status bar.

 *Note: If calibration results in a red bar, CVAL sets a suspect calibration flag when ingesting Multisonde calibration files. A suspect calibration generally means the calibration result is a failure. If the sensor fails again, conduct a factory reset and re-calibrate the sensor two more times to verify the results are accurate. If calibration results in a caution (exclamation point) or failure QC score, or if you perform an override, CVAL sets a suspect calibration flag when ingesting Multisonde calibration files. A suspect calibration generally means the calibration result is a failure. If the sensor fails again, conduct a factory reset and re-calibrate the sensor two more times to verify the results are accurate.*

Afterwards, click **“Exit”** in the **Device Calibration** window to return to the sensor Calibration Menu. **Discard all used fDOM calibration solution.**

RINSE SENSOR PROBES 3X WITH DI TO PREPARE FOR NEXT CALIBRATION.



5.4.2.7 Field Calibration Procedure: pH

Ensure the pH sensor is clean before conducting calibrations (reference Section 5.3.10.3).



Figure 102. pH Probe Calibration Buffer Solutions

STEP 1 | This sensor requires three buffer solutions for a three-point calibration: pH 7.00, pH 10.00, and pH 4.00

Figure 102 is displaying from left to right: pH 4.00, pH 7.00, and pH 10.00.

These solutions require minimal preparation.



Figure 103. pH Buffer Solutions in Stream

STEP 2 | When onsite, equilibrate the solutions in the stream water (**Figure 103**). Reference Section 5.4.2.1 for instructions.

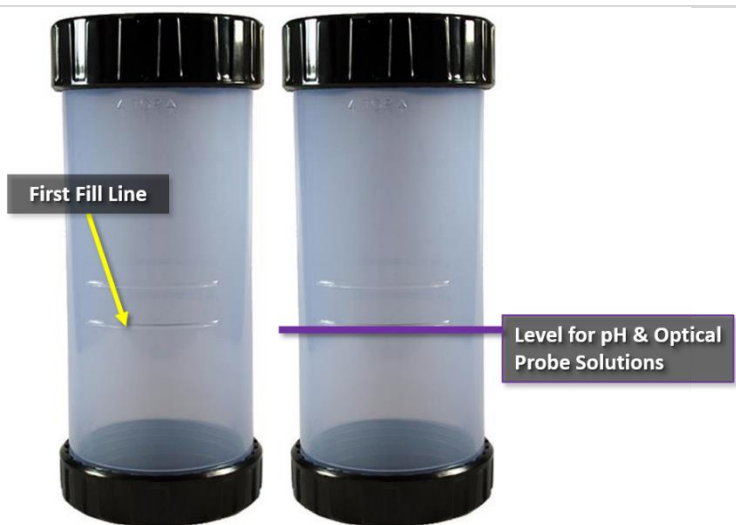

Figure 104. Fill the Calibration Cup with Buffer Solution to 1st Line

STEP 3 | Triple rinse the calibration cup with the pH 7.00 buffer (first calibration solution) and then fill the calibration cup to the first fill line with this first solution standard (Figure 104).

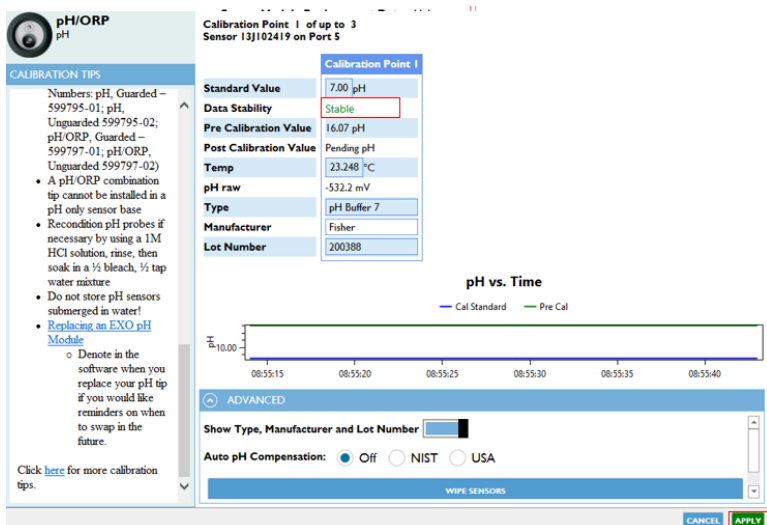

Figure 105. First calibration point.

STEP 4 | In the Kor software, select the port with the pH sensor probe in the Calibration Menu and then select pH to proceed. In the Device Calibration window, input the following information for a 3-point calibration process (Figure 105):

- Enter Standard Value: *This is site-specific. Use the temperature corrected value determined using the Fulcrum Calibration and Cleaning Application or determine it manually using the label of the stock solution bottle.*
- Enter Type: pH 7 Buffer
- Enter Manufacturer
- Enter Solution Lot Number

Once data is stable, click “**Apply**” to progress to the second calibration point.

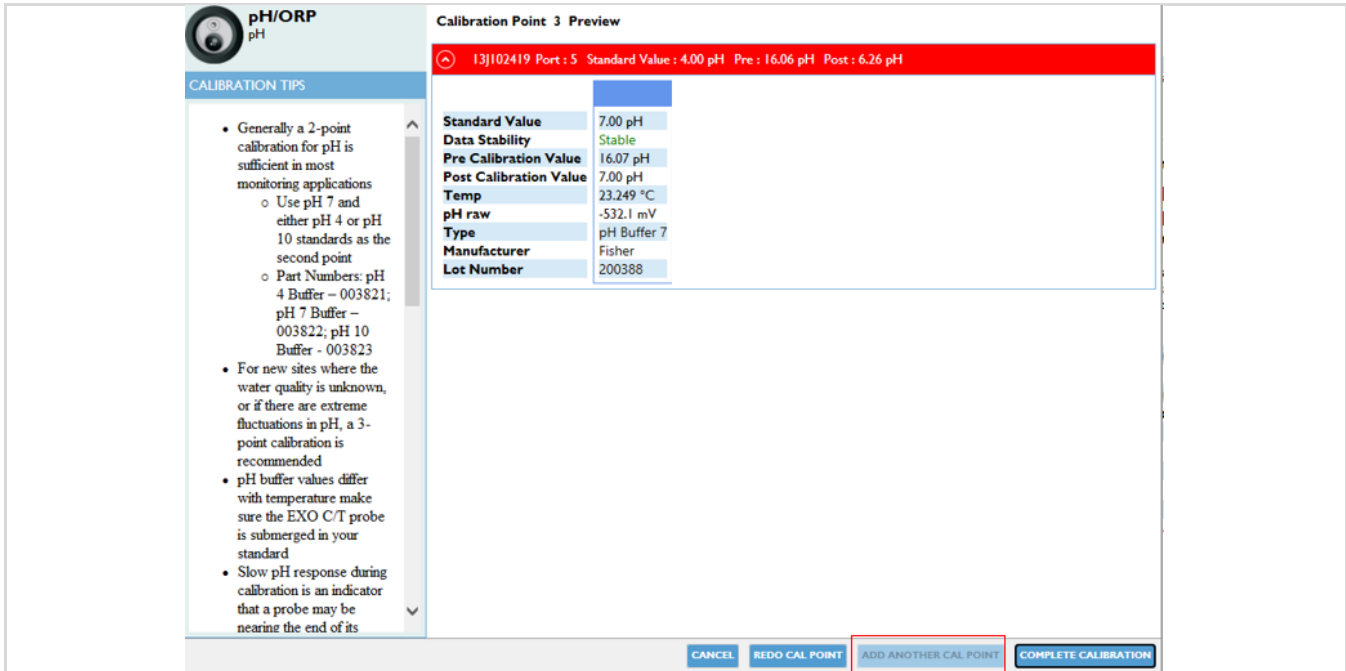



Figure 106. From this menu, select "Add Another Cal Point" to proceed to the second and third values.

STEP 6 | For Calibration Point 2 of 3, repeat the same actions as the previous step. Triple rinse with each standard between each step. It is OK to use expired buffer solutions for the triple rinse. Do not use expired solutions for the calibration step. Click "OK" in the Proceed to Standard pop-up window (**Figure 106**).

STEP 7 | For the final calibration point (Calibration Point 3 of 3), again, wait for the data to stabilize, then click "Apply", and then click "Complete Calibration".

STEP 8 | Review the Calibration Summary data to determine if the sensor passes/fails calibration. The QC score informs the pass/fail status for the field calibration. A passing calibration results in a green status bar.

 *Note: If calibration results in a red bar, CVAL sets a suspect calibration flag when ingesting Multisonde calibration files. A suspect calibration generally means the calibration result is a failure. If the sensor fails again, conduct a factory reset and re-calibrate the sensor two more times to verify the results are*

Click "Exit" to return to the Calibration Menu.

RINSE SENSOR PROBES 3X WITH DI TO PREPARE FOR NEXT CALIBRATION.

5.4.2.8 Field Calibration Procedure: Dissolved Oxygen (DO)

Ensure the DO sensor is clean before conducting calibrations (reference Section 5.3.10.2).



Figure 107. Fill Bottom of Calibration Cup with DI Water for DO Probe

STEP 1 | Calibrate the DO sensor probe. Use the black guard to calibrate this optical sensor.

Fill the calibration cup with just enough DI water to cover the bottom of the calibration cup. (**Figure 107**). The DI water must not touch the DO probe. Be careful – do not allow water droplets on the sensing window of the DO probe.

Do not fully tighten the calibration cup to the Sonde body. This allows for venting and for barometric pressure to equalize.

Allow 15 minutes for the DI water in the calibration cup to reach equilibrium with the surrounding ambient air. *Reference Section 5.4.2.1 for more information.*

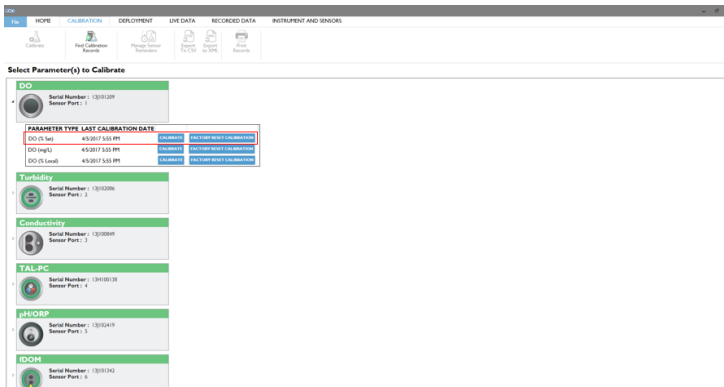

Figure 108. Select ODO % Sat.

STEP 2 | In the Kor software, select the port with the DO sensor probe. Under the Calibration Menu, select **ODO % sat** unit (**Figure 108**).

STEP 3 | Input the following information in the **Device Calibration** window for a 1-point calibration process (**Figure 109**):

- BarommHg: This is **site-specific**. Use the value from the barometer (barometric sensor) that resides on the nearest Met Station. Field

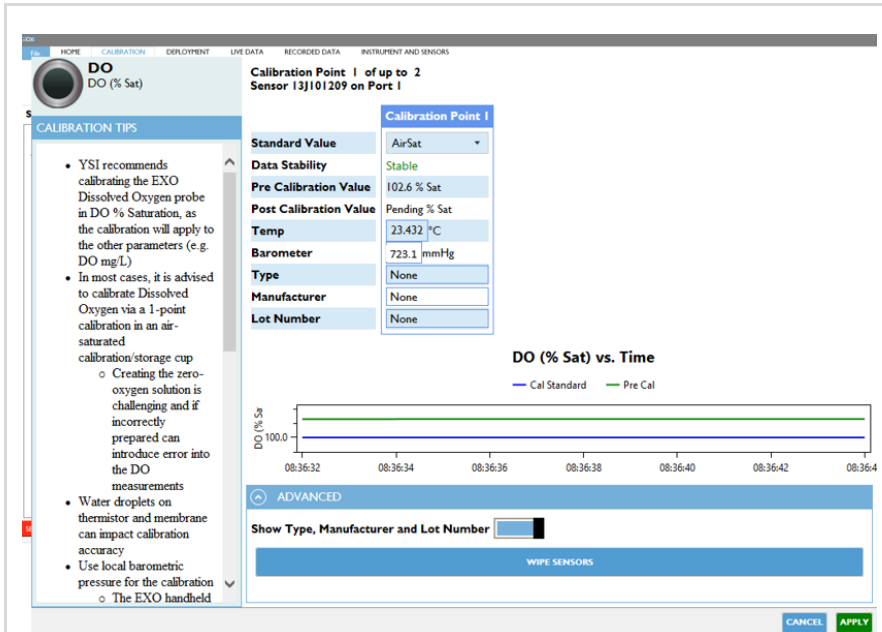

Figure 109. Enter values for first calibration point.

Science may also use their Domain’s YSI Handheld if it matches the values of the barometer on the Met Station at least 3x a year. If no barometric data can be utilized, DO NOT calibrate. If this causes more than a month of delay, contact AIS Science staff to find an alternative source of data.

- Select 1-Point Calibration
- Enter Standard Value: Saturated Air
- Enter Type: Air-Saturated
- Enter Manufacturer: DI Water

Ensure the DI Water has had at least 15 minutes to reach equilibrium in the calibration cup. Once 15 minutes have passed and data remains stable, click “**APPLY**”.

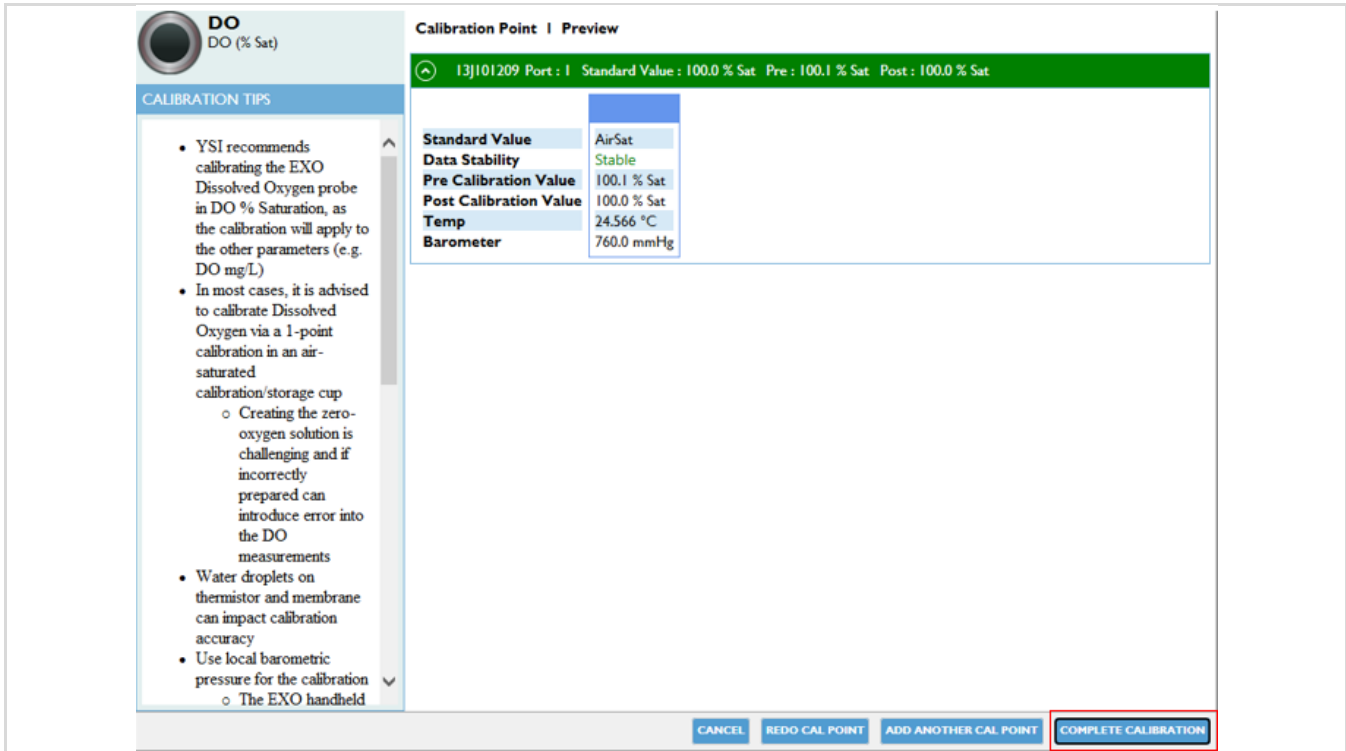



Figure 110. Complete the single point calibration..

STEP 4 | Review the Calibration Summary data to determine if the sensor passes/fails calibration. The QC score informs the pass/fail status for the field calibration. A passing calibration results in a green status bar.

 *Note: If calibration results in a red bar, CVAL sets a suspect calibration flag when ingesting Multisonde calibration files. A suspect calibration generally means the calibration result is a failure. If the sensor fails again, conduct a factory reset and re-calibrate the sensor two more times to verify the results are accurate.*

Click “Exit” to return to the Calibration Menu.

RINSE SENSOR PROBES 3X WITH DI TO PREPARE FOR NEXT CALIBRATION.
(If this is your last calibration, then disregard this step.)

5.4.2.9 Field Calibration Procedure: Depth Sensor (Buoy Sites Only)

This section only applies to Multisondes at AIS Buoy sites, with the exception of the D03 FLNT Buoy. Ensure the depth sensor is clean per Section 5.3.6.

STEP 1 | Conduct a single point calibration to calibrate the depth sensor. The depth sensor is a pressure transducer in the body of the Multisonde. This calibration does not require the use of solutions. The Multisonde must be above water, in ambient air.

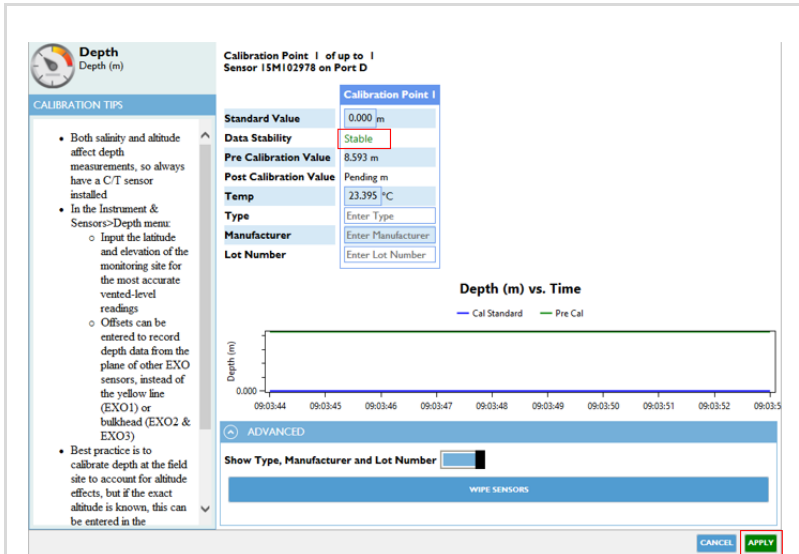

Figure 111. Depth calibration point.

STEP 2 | In the Kor software, under the Calibration Menu, select Depth. Input the following information (**Figure 111**):

- Select 1-point calibration
- Enter Standard Value: 0.00

Wait for data to become stable, then click “Apply” (**Figure 108**).

STEP 3 | Observe the readings and when the data are Stable, or when data shows no significant change for approximately 40 seconds, click “Apply”, and then “Complete Calibration”. Review the Calibration Summary data with Section 5.4.2.10 to determine if the sensor passes/fails calibration. The QC score informs the pass/fail status for the field calibration. A passing calibration results in a green status bar. Click “Exit” to return to the Calibration Menu.

5.4.2.10 Pass/Fail Calibration Criteria

5.4.2.10.1 Cleaning Bout Criteria

Every two weeks a cleaning preventative maintenance bout must be performed. Refer Section 5.3.9 for probe-specific instructions on technique and cleaning solutions to be used. After entering clean sonde readings into Fulcrum, a Successful/Unsuccessful determination will be made using specific criteria.

Conductivity	> 2% difference
pH	> 0.4 pH
Turbidity	> 5FNU or > 10% difference, whichever is greater
fDOM	> 2 QSU or >2% difference, whichever is greater
DO	> 2% difference

Figure 112. S1/S2 Clean comparison criteria.



Title: NEON Preventive Maintenance Procedure: AIS Surface Water Quality Multisonde		Date: 04/19/2022
NEON Doc. #: NEON.DOC.001569	Author: B. Nance, D. Monahan, M. Mahal, M. Cavileer	Revision: D

5.4.2.10.2 Calibration Bout Criteria

Upload the Multisonde Calibration files via the IS Control and Monitoring Suite. Instructions on this process are in Section 8 Field Calibration Data Transmission Instructions on page 112.

The following flow charts provide a high-level summary of the calibration pass/fail process. **Figure 113** applies to sites with two Multisondes, sites that employ the bucket test. **Figure 114** applies to sites with one Multisonde. These sites do not conduct a bucket test. If the Multisonde fails calibration in either process, submit an incident ticket to inform AIS Science staff for data quality monitoring/tracking and to coordinate troubleshooting/replacement with other HQ departments.

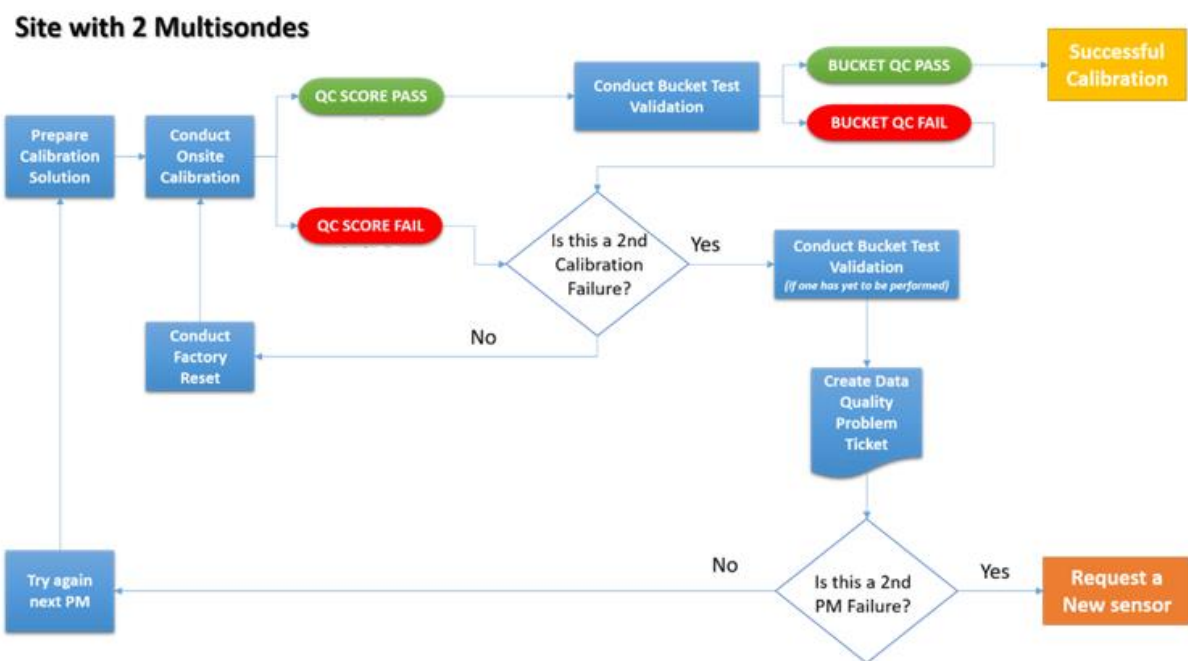

Figure 113. Calibration Pass/Fail criteria for sites with two (2) multisondes.



Title: NEON Preventive Maintenance Procedure: AIS Surface Water Quality Multisonde		Date: 04/19/2022
NEON Doc. #: NEON.DOC.001569	Author: B. Nance, D. Monahan, M. Mahal, M. Cavileer	Revision: D

Site with 1 Multisonde

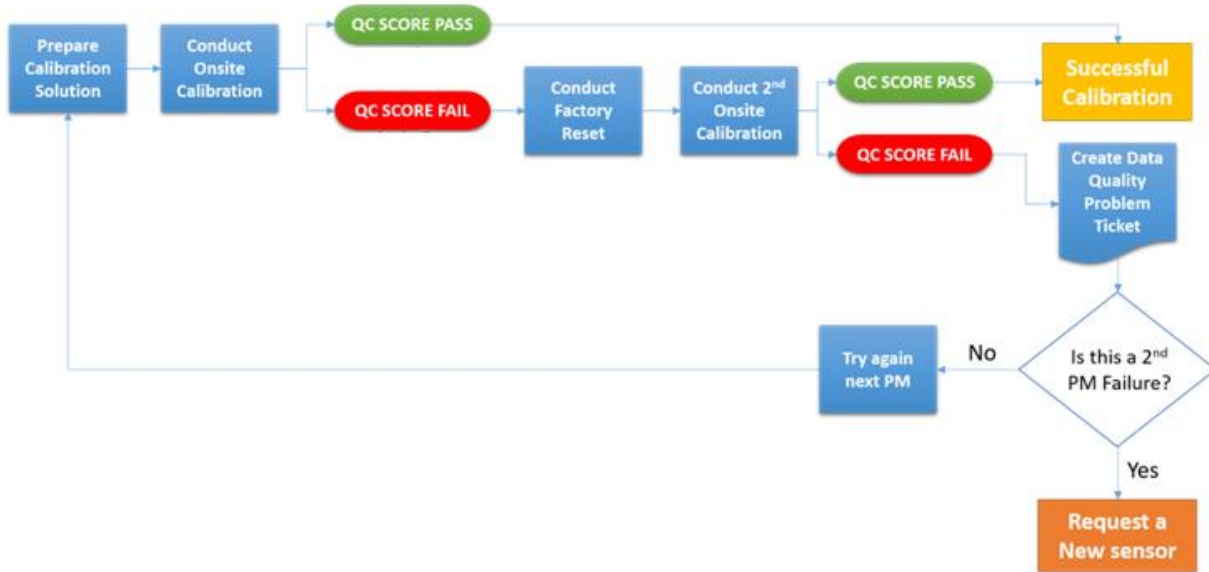

Figure 114. Calibration Pass/Fail criteria for sites with one (1) multisonde.

The following section provides detail on passing and failing (Section 5.4.2.10.3).



5.4.2.10.3 PASS/FAIL CRITERIA

The QC Score determines whether the sensor passes or fails calibration. Sensors that pass calibration result in a green bar in the final calibration summary window (**Figure 115**). The sensor fails calibration if it results in a red bar in the final calibration summary window (**Figure 116**).

Calibration Point | Preview

13|I01342 Port: 6 Standard Value: 0.00 QSU Pre: -1.10 QSU Post: 0.00 QSU

Standard Value	0.00 QSU
Data Stability	Stable
Pre Calibration Value	-1.10 QSU
Post Calibration Value	0.00 QSU
Temp	23.332 °C
Type	DI
Manufacturer	D08
Lot Number	

Buttons: CANCEL, REDO CAL POINT, ADD ANOTHER CAL POINT, COMPLETE CALIBRATION

Figure 115. Green bar indicates a successful calibration.

Calibration Summary

13|I02419 Port: 5 SmartQC™

Calibration Date: 8/4/2021
 pH 4 and 7 Delta Slope: 0.38 mV
 0.13 mV per Decade
 pH 7 and 10 Delta Slope: -0.28 mV
 -0.09 mV per Decade

Standard Value	7.00 pH	10.00 pH	4.00 pH
Data Stability	Stable	Stable	Stable
Pre Calibration Value	16.07 pH	16.06 pH	16.06 pH
Post Calibration Value	7.00 pH	10.01 pH	6.26 pH
Temp	23.249 °C	23.251 °C	23.257 °C
pH raw	-532.1 mV	-531.8 mV	-531.7 mV
Type	pH Buffer 7	pH Buffer 10	pH Buffer 4
Manufacturer	Fisher	Fisher	Fisher
Lot Number	200388	200389	200387

Enter calibration notes:

Buttons: VIEW CALIBRATION WORKSHEET, EXIT

Figure 116. Red bar indicates a failed calibration.

If a sensor fails calibration after three attempts, initiate corrective actions. Leave the sensor that failed calibration installed onsite. When returning to the Domain or upon internet connection, submit an incident ticket for AIS data quality and troubleshooting. As soon as possible, and certainly no later than

Title: NEON Preventive Maintenance Procedure: AIS Surface Water Quality Multisonde		Date: 04/19/2022
NEON Doc. #: NEON.DOC.001569	Author: B. Nance, D. Monahan, M. Mahal, M. Cavileer	Revision: D

your next preventive maintenance bout, return to the site with fresh calibration solution (to rule out calibration solution issues) and DI water to conduct calibrations again for passing scores.

If the sensor fails during the second trip with new/fresh calibration solutions and DI water, leave the sensor onsite and request a new sensor in a task under the same incident ticket that was created initially to inform AIS Science of the failed calibrations.

5.5 Saving Calibration Files

After completing any calibration work, the data file needs to be saved and uploaded to HQ (Section 8). Before disconnecting from Multisonde, navigate to the **“Field Calibration Record”** tab and select **“Export to CSV”**. This will bring up a window to select all calibrations associated with the current PM bout. Save this file to **“C:\Test_Data\Sonde_Data”** for upload once back at domain.

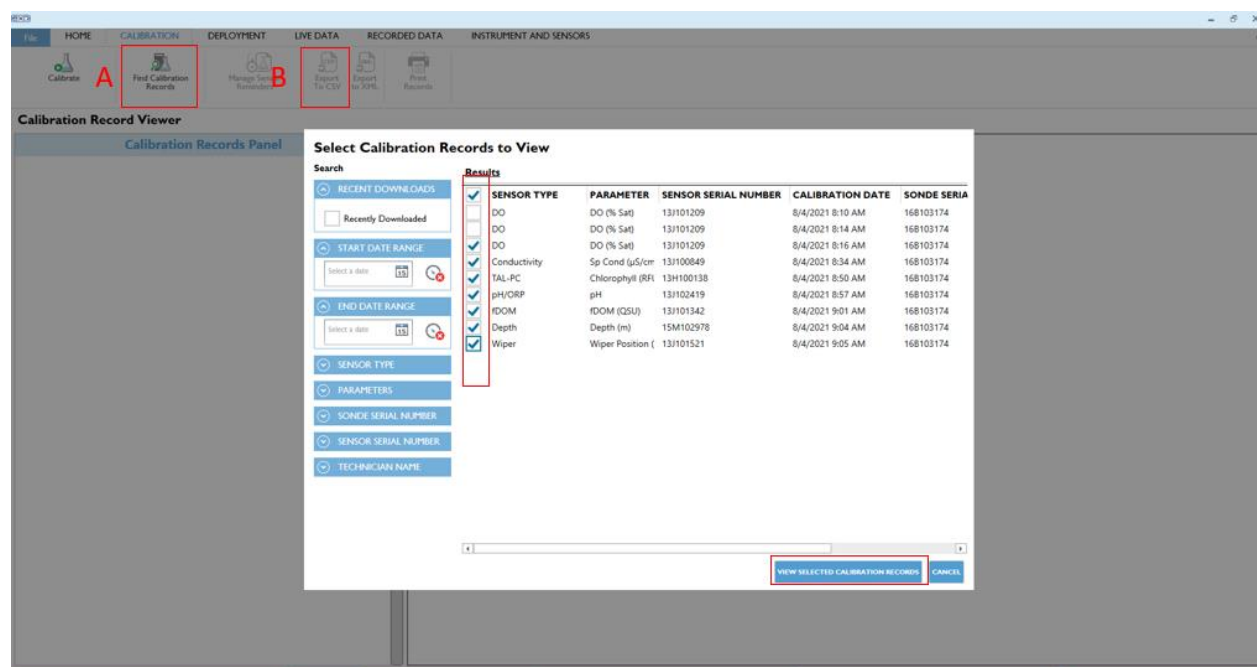

Figure 117. At the end of every PM, collect calibration into one CSV.

5.6 Seasonal Maintenance (Stream Sites)

This section addresses seasonal changes in stream flow that may affect the sensor function and data collection. Per aquatic science requirements, sensors and infrastructure shall be installed and adjusted seasonally, as directed by HQ and according to the preventative maintenance documentation. In order to sample vital sections of the stream to capture data indicative of the stream, water quality, temperature, and nutrient measurements must be captured at 50% ($\pm 20\%$) of the total water depth. This requirement excludes temporary changes in water depth, which may occur from large and rapid due to storm events. Conduct the following actions to address the scenarios in **Table 17** to ensure sites



Title: NEON Preventive Maintenance Procedure: AIS Surface Water Quality Multisonde		Date: 04/19/2022
NEON Doc. #: NEON.DOC.001569	Author: B. Nance, D. Monahan, M. Mahal, M. Cavileer	Revision: D

maintain compliance with AIS science requirements. Reference AD [04] for thresholds and seasonal guidance on the sensors that mount to the AIS Buoy.

Table 17. Seasonal Maintenance: Stream Flow Changes



Figure 118. Dry Stream Bed (D14 SYCA)

SCENARIO 1 | As mentioned above, per aquatic science requirements, the Multisonde needs to be set to record data from 50 % (\pm 20%) depth. This requirement aims to capture data from the most well mixed and representative part of the water column.

Lower and raise the Multisonde body (and SUNA) to maintain the sensors at this depth requirement.

In addition, whenever AIS sensor locations change onsite, Field Science must complete a Location Tracking form in the Fulcrum Application to inform AIS SCI of the new location. Update the Site As-Built documentation with this change.

DO NOT move the Level Troll unless it is for Sensor Refresh or Corrective Maintenance in coordination with HQ.

If water levels drop to a level where Field Science can no longer move the sensor to submerge the probes in water, create an incident ticket to inform AIS Science that the Multisonde is dry.

Remove the DO and pH sensor probes from the Multisonde, IF the streambed is dry, meaning the probes are no longer in a “moist” environment. However, if there is any chance a pulse may occur within seven (7) days, do not remove the sensor. Consult with AISCI for authorization to remove these sensors and report the removal date/time.



Figure 119. Winter Season Ice Accumulation (D18 OKSR)

SCENARIO 2 | The Multisonde remains onsite in its installation location during the winter, with exception of Multisondes in Alaska (Domain 18 and 19). However, if Field Science is aware that the stream may completely freeze (ice down to the substrate; no water flowing) under within 2 weeks/before the next site visit, consult with AIS SCI for authorization to remove the sensor. See AD [04] for lake and river seasonal guidance.

In D18/19, streams tend to freeze to the streambed. AIS Science requests that D18/19 Aquatic Field Ecologists/Technicians monitor streams to assess if sites conditions change (the stream no longer completely freezes). Submit an incident ticket to inform AIS SCI of any changes.

For D18 Oksrukuyik Creek (OKSR): See RD [11]. Remove the stream sensors when the site alternate power system is OFF for the winter season.



Figure 120. NEON.D07.LECO.DP1.20002 High Flow Events

SCENARIO 3 | For imminent high-flow events (**Figure 120**), the site is likely not safe to access. Consult the NEON program Safety office and AIS SCI staff for guidance.



Figure 121. Seasonal Hazards

SCENARIO 4 | Seasonal hazards (e.g., **Figure 121**) vary from site to site. Consult the NEON program Safety office and AIS science staff for guidance.

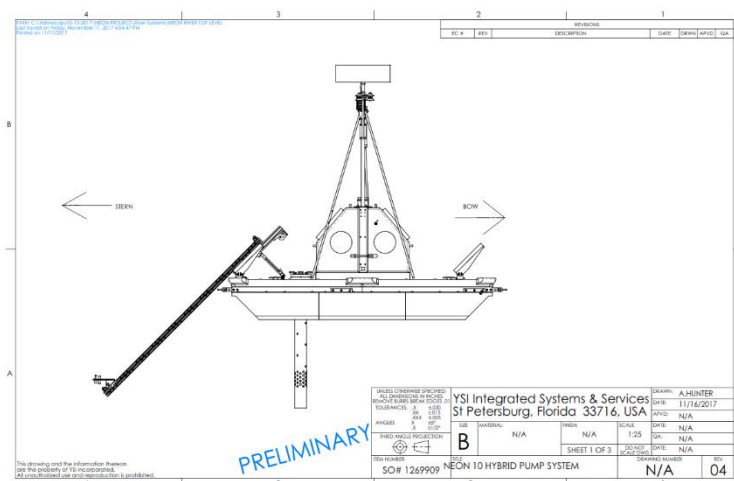

Figure 122. D03 FLNT River Buoy Drawing with Standpipe

SCENARIO 5 | This is a unique scenario that will likely only apply to the D03 FLNT Buoy. The FLNT Buoy has two standpipes for the SUNA and Multisonde. These affix to the grated deck below the buoy (part of the submerged underwater sensor set). When the Domain is anticipating a potential low flow event, submit an incident ticket and consult with AIS Science to determine the best course of action.

If low flow is imminent, remove the standpipes from the buoy. Adjust the Multisonde intake tubes to prevent the pump from collecting river substrate/mud. Per AIS Science, new depths for tubing should be 0.5m and 0.75m. Verify with AIS Science if these measurements require adjustments depending on the flow dynamics of the river. See *INC0023136 in ServiceNow* for historical information.



6 REMOVAL AND REPLACEMENT (SUBSYSTEM ONLY)

6.1 Equipment

Table 18. Equipment for Sensor and Subsystem Removal and Replacement

Maximo No.	Description	Quantity
Tools		
GENERIC	Open Ended Wrenches	Set
MX109759	Ratchet set	Set
MX109746	Allen Wrenches (5/16 Allen Wrench to remove Multisonde enclosure)	Set
MX101649	Greenlee 0254-40 10 Pc T-Handle Hex Key Set	1
MX101639	Screwdriver set (flathead screwdriver to open Combo boxes)	1
MX102345	Measuring Tape	1
MX105024	Torque Wrench	1
NEON, Safety	Aquatic PPE	A/R
MX101632	PETZL Headlamp, Wide Beam, Gray	1
NEON, Safety	LOTO Equipment	A/R
MX102703	Digital Multi-Meter (DMM)	1
MX109755	Flush cut pliers or scissors (to remove zip ties)	1
MX102767	11-in-1 Screwdriver/Nut driver w/Interchangeable Blade	1
MX104238	SK Alum Edge Folding Utility Knife w/Belt Clip, Blue 3.5"	1
MX103120	Anti-static wristband	1
Consumable items		
	UV-resistant Zip ties	A/R
MX105865	3M Bag, ESD Shielded, 8 inch x 11 inch, Cushioned	1
MX105931	3M Bag, ESD, Static Shield, 6 x 8 Inches, Zip Closure, Non-Cushioned	1
MX105864	3M Bag, ESD Shield, 6 Inch X 7 Inch, Cushioned	1
MX105866	3M Bag, ESD Shielded, 14 Inch X 15 Inch Cushioned	1
MX105935	3M Bag, ESD, Static, 15 x 18 Inches, Zip-Closure Top	1
GENERIC	Masking tape	Roll
GENERIC	Sharpie/Paint pen	1
GENERIC	Boxes (to transport non-decontaminated sensors back to Domain)	A/R

 *Note: Maintain original product packaging for use in future sensor swaps (calibration and validation), temporary storage, or to return defective equipment.*

6.2 Removal and Replacement Procedure

The Field Operations Manager is responsible for managing the removal and replacement of the sensors onsite for preventive maintenance and/or sensor swaps, as well as field calibration and validation of sensors, as appropriate. CVAL is responsible for the annual calibration and validation of select sensors and manages the Domain sensor swap schedules. **Reference RD [07] for the standard operating procedures for the annual Sensor Refresh process and delineation of sensor, administrative and logistical requirements.**



To minimize data downtime and optimize the availability of sound data, coordinate instrumentation and subsystem **annual** calibration, validation and preventive maintenance requirements to occur within the same timeframe.

6.2.1 Stream Sites (S1 and S2)

Conduct the following removal and replacement procedures for the Multisonde at wadeable stream sites in **Table 19** and **Table 20**, respectively. Reference *AD [05]*, *NEON.DOC.003880 NEON Preventive Maintenance Procedure: AIS Stream Infrastructure* for additional information to support or compliment this procedure. This procedure contains some relevant information for Multisondes that sample along a vertical profile from the AIS Buoy.

6.2.1.1 Removal Procedure

Table 19 provides basic instructions on how to remove the Multisonde and its subsystem equipment for Sensor Refresh.

Table 19. Multisonde Removal Procedures for Stream Sites



Figure 123. AIS Combination Box - 5 Amp Breakers

STEP 1 | Power down S2 from the Combo Box. Use a flathead screwdriver to open the Combo box (**Figure 123**).

Reference AD [06] for additional guidance on the AIS power distribution system.

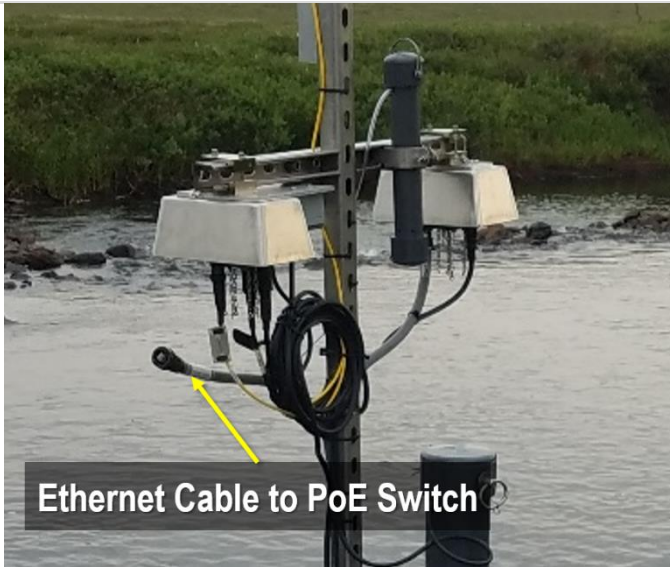



Figure 124. Disconnect Ethernet Cable (RJF) from Merlot Grape

STEP 2 | Disconnect the Ethernet Cable (RJF/Eth to Comm on AIS Interconnect Mapping) from the 12V Merlot Grape that powers and acquires data from the Multisonde. This cable connects to the PoE Switch. **Figure 124** shows this cable disconnected from the Grape. Drape the cable over the anchor or device post if zip ties do not hold it in place above water. Do not allow the cable connector to get wet or dirty.

 *Note: Always remove the Ethernet cable from the Grape prior to connecting and disconnecting sensor cables; this de-energizes the Grape (data acquisition device) to prevent damage to the mechanism.*

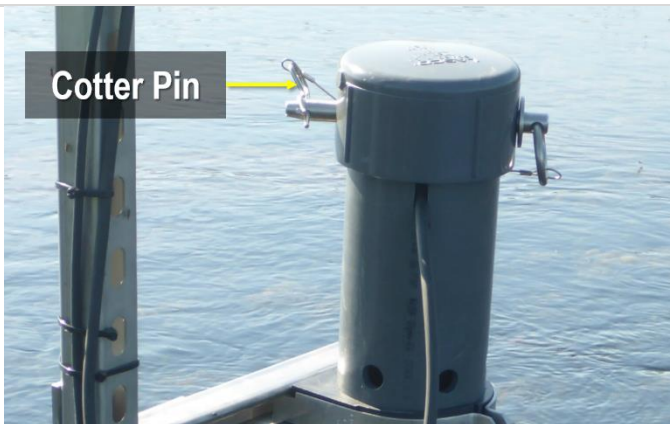

Figure 125. Remove Cotter Pin to Remove PVC Slip Cap

STEP 3 | Remove the cotter pin securing the PVC slip caps that cover the top of each PVC enclosure (**Figure 125**).

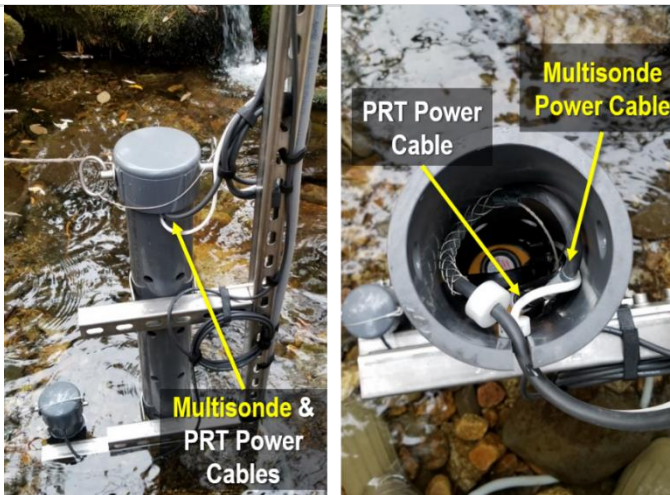

Figure 126. Disconnect Sensor Power Cable

STEP 4 | Remove the Multisonde and disconnect the sensor power cable that connects to the Grape (**Figure 126**). The Multisonde uses a 12V Merlot Grape. These either mount to the stream anchor above the sensor or nearby on a device post onshore. Remove zip ties that are securing the sensor cable to the anchor, using snips, as appropriate to remove the cable, if necessary, otherwise drape the cable above water to prevent submerging the connectors. HQ recommends placing a dummy plug over the sensor 6-pin bulkhead connector to protect it from getting wet.



STEP 5 | Remove each Multisonde probe using the Multisonde probe removal tool (**Figure 127**). Insert the probe tool securely into the locking nut and turn it left. Over time, removing/reinstalling sensors on the Multisonde wear down/strip the locking nuts. Ensure the tool is securely in the hole before turning and try not to over-torque when removing to prevent the tool from stripping the nut.

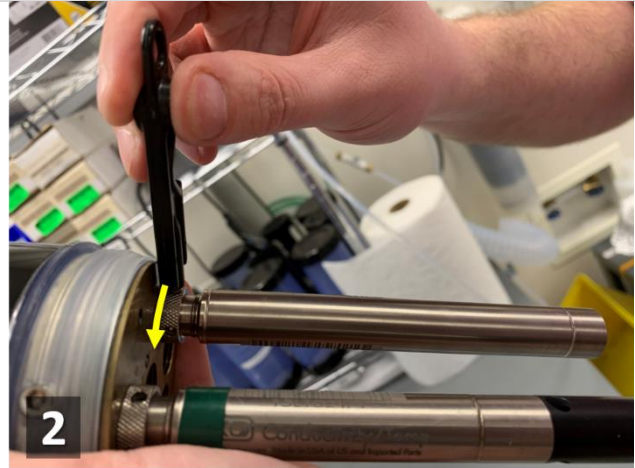

Figure 127. Use the Multisonde Probe Tool to Remove each Sensor Probe from the Multisonde

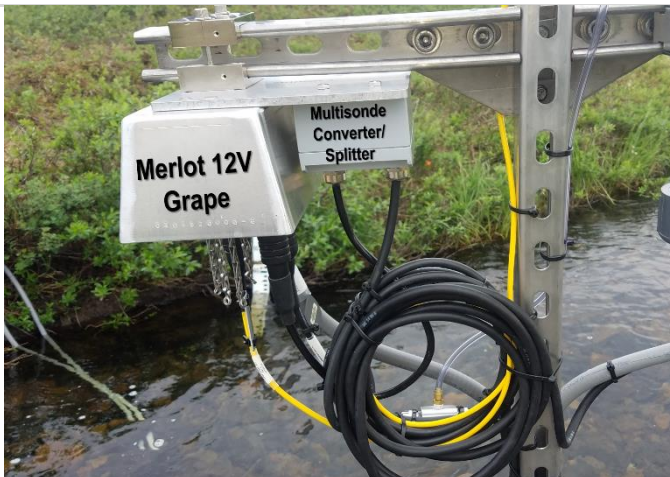

Figure 128. Multisonde Merlot Grape in Grape Shield with Converter/Splitter Box

STEP 6 | If not already complete, remove the other sensor connections from the 12V Merlot Grape and remove the Grape for Sensor Refresh (**Figure 128**). The converter/splitter box remains on the anchor unless removing the sensor for winterization. If moving for winterization, remove the entire assembly that mounts to the Unistrut.

Remove the four screws that affix the Grape to the Grape Shield (also referred to as a bread pan) using a hex wrench.

It may be easier to remove the Grape Shield(s) from the anchor Unistrut to prevent losing the four screws that secure the Grape to the shield. Use a 3/16" hex wrench to remove the entire assembly with the Grape. Store Grapes without caps in an ESD bag.

6.2.1.2 Replacement Procedure

Table 20 provides basic instructions on how to replace the Multisonde and its subsystem equipment for Sensor Refresh.



Table 20. Multisonde Replacement Procedures for Stream Sites

STEP 1 | Reinstall new or “refreshed” sensor probes (**Figure 129**). Ensure the Multisonde bodies at stream sites remain in their original location to ensure the sensor aligns with its CFGLOC in Maximo. *For more information on why this matters, see Section 9 Multisonde Configuration in Maximo on page 119.*

 *Note: If the sensor is brand new from YSI, then the connector is pre-greased.*



Figure 129. How to Reinstall a Sensor Probe



Figure 130. Reinstall the Multisonde Grape

STEP 2 | Reinstall a new 12V Merlot Grape into a Grape Shield (**Figure 130**) by threading the four screws that affix the Grape to the Grape Shield using a hex wrench.

Reference AD [10] for AIS Grape Mapping.

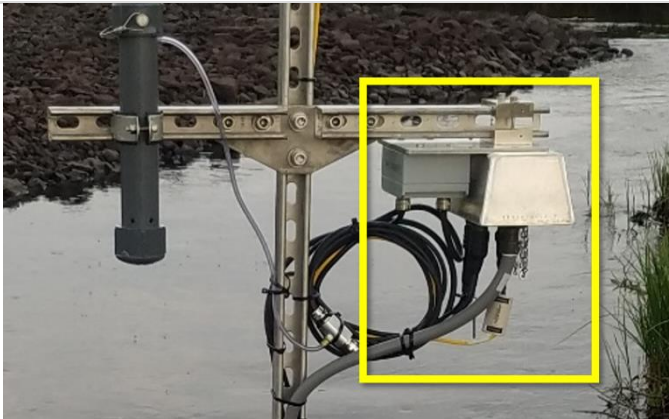

Figure 131. Connect Sensor Cables to Grape

STEP 3 | Remove dust caps on sensor connections and Eth-To-Comm connector. Reconnect sensor and armored Ethernet cable in accordance with AD [10]. **Figure 131** is a complete installation of the Multisonde subsystem Grape.

Use the dust caps from the new Merlot when shipping back the old Merlot for Sensor Refresh.

Ensure the caps are decontaminated if used on a non-decontaminated Grape when returning Grapes to HQ.



Figure 132. Multisonde Cable Dressing - Complete Installation

STEP 4 | Dress cables with zip ties to look similar to **Figure 132**.

Use flush cuts to cut off the remaining zip tie to ensure the cut zip tie is flush. Do not litter the site with leftover zip ties. Ensure these are disposed of properly.

STEP 5 | Restore power to S1 or S2 from the Combo Box (reference **Figure 123**).

STEP 6 | Verify the Multisonde probe data streams are present via the Location Controller (LC) and the sensor shows up in the SAS Report the next day. If the Multisonde is not in the SAS Report in the next reporting period, ensure the Multisonde Probes CFGLOGs are accurate in Maximo (reference Section 9



Multisonde Configuration in Maximo on page 119 for more information). Double check to see if the probe data streams are streaming through an SSH Client like PuTTY or the LC Monitoring and Control Suite.

If the data streams are accurate in Maximo, but not showing up in the LC Control and Monitoring Suite, the SAS Report, or daily status emails, power-cycle the Multisonde Grape through the PoE Switch. Power the Grape down for 10-15 minutes. Do this if the Multisonde disappears in the daily status emails from Engineering Services or the SAS Report. Submit a ticket if the Multisonde data are not streaming to conduct remote troubleshooting with HQ guidance, as applicable.

 *Note: If there any issues during this process and require HQ assistance onsite, use the Engineering Service Line: 720-836-2470.*

6.2.2 Lake and River Sites (Buoy)

For lake and river sites, to include D03 FLNT, reference Section 6 in *AD [04], NEON.DOC.004613 NEON Preventive Maintenance Procedure: AIS Buoy* for removal and replacement procedures. This procedure also includes maintenance on the infrastructure for the Multisonde vertical profiling system (i.e., the Winch System or for D03 FLNT, the Pump System and PVC Fixed Tube).

6.2.3 Central Wiper Brush Removal & Replacement

STEP 1 | Ensure the Multisonde is not sampling and the central wiper brush is currently not in use.

STEP 3 | Loosen setscrew with a 0.050 inch Allen wrench. Remove the old brush assembly and clean any residue from wiper shaft and wiper end cap.

STEP 4 | Install the new brush assembly by gently pressing the wiper arm down against the shoulder on the wiper shaft.

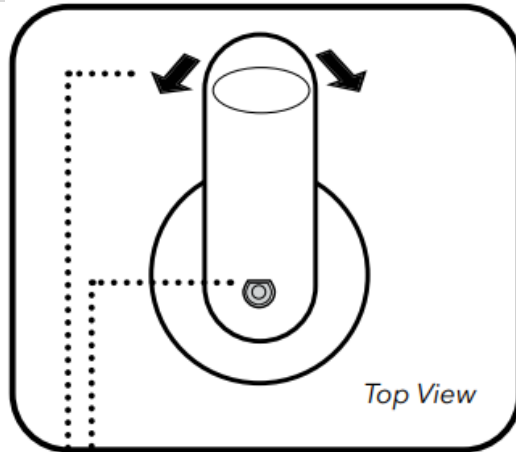

Align set screw in D shaft
Rock brush back and forth

Figure 133. Rock Brush to ensure Fit against the D Shaft

STEP 5 | Tighten setscrew to a torque of 4 inch-pounds.

While tightening, gently and slowly rock the brush to ensure a tight fit against the D shaft (**Figure 133**).

Check snugness of wiper by gently rocking 5 degrees in either direction.



6.3 Cleaning & Packaging of Returned Sensor

Field Science staff decontaminate, package, and ship sensors back to the CVAL at the NEON Program HQ (Battelle) for annual Sensor Refresh (swap)/calibration requirements. Please note: if a sensor is defective, submit an incident in the NEON Program’s Issue Reporting and Management System and affix a red tag with the incident number on it (Figure 141).

Note: Asset tags (Figure 134) for each sensor must return with the sensor shipment to HQ. Each sensor must reflect CFGLOC changes in the NEON Program Asset Management System. If an asset tag is missing for a sensor, contact the NEON HQ property management office for guidance and awareness for when the shipment arrives at HQ. Do not send the asset tag for the Multisonde body to HQ during Annual Sensor Refresh. This must remain with the sensor.



Figure 134. Multisonde Probe Sensor Asset Tags

Important: DO NOT tamper with, change or reassign asset tags from Data Generating Device (DGDs) without direct consent from HQ property management office. This prevents chain of custody and/or data issues that tie to asset tags.

6.3.1 Decontamination Requirements

Conduct decontamination procedures when shipping the sensor to HQ for annual Sensor Refresh, Winterization or Repair Lab. In addition, per NEON.AIS.4.1735, all vehicles, trailers, boats, tools, protective outerwear, and any other items that encounter an aquatic or riparian environment, require decontamination prior to site access. Reference RD [03], NEON.DOC.004257 NEON Standard Operating Procedure (SOP): Decontamination of Sensors, Field Equipment and Field Vehicles for instructions to prevent cross-contamination of invasive species and other biological matter from sites.

Note: Field Science must not transport non-decontaminated sensors in the same shipping and packing materials that are for shipping decontaminated sensors to CVAL. Use a plastic liner to protect the shipping materials from site biologics.



Title: NEON Preventive Maintenance Procedure: AIS Surface Water Quality Multisonde		Date: 04/19/2022
NEON Doc. #: NEON.DOC.001569	Author: B. Nance, D. Monahan, M. Mahal, M. Cavileer	Revision: D

6.3.2 Long- and Short-Term Probe Sensor Storage Requirements

This section identifies storage as “long-term” or “short-term” in accordance with ER [02] and ER [03] in **Table 21**. Long-term denotes storage during times of long inactivity (over winter, end of monitoring season, etc.). Short-term denotes transitory timeframes and temporary breaks in service due to seasonal environmental events, repair, and/or refresh activities. Store the sensor body in a dry environment between -20 and +80°C.

Table 21. Probe Sensor Storage Requirements

Probe Sensor	Storage Requirements
<i>Optical Sensor Long- and Short-Term Storage</i>	Turbidity, Chlorophyll, and fDOM require minimal precautions. Users can either remove the sensors or leave them installed in the Multisonde for long- and short-term storage. If left installed on the Multisonde, follow guidelines for Multisonde storage. If users remove them from the Multisonde, the sensors may be stored in dry air in their shipping cap (to protect against physical damage).
<i>Conductivity/ Temperature Sensor Short-Term Storage</i>	When in regular field use, the sensor should remain installed on the Multisonde in an environment of water-saturated air. Place approximately 0.5 in (1 cm) of any water (deionized, distilled, tap, or environmental) in the bottom of the calibration cup. Insert the Multisonde and sensor into the cup and screw it on tightly to prevent evaporation.
<i>Conductivity/ Temperature Sensor Long-Term Storage</i>	Store the sensors either dry or wet, installed on the Multisonde or detached. However, before storage, clean the sensor per Section 5.3.8 to ensure the sensor is in good working order for the next deployment season.
<i>Dissolved Oxygen Sensor Short-Term Storage</i>	<p>When in regular field use, the ODO sensor should remain installed on the Multisonde. Place approximately 0.5 in (1 cm) of any water (deionized, distilled, tap, or environmental) in the bottom of the calibration cup. Insert the Multisonde and sensor into the cup and screw it on tightly to prevent evaporation.</p> <p> <u>Note: Do not submerge the Multisonde pH sensor probe in distilled water.</u></p> <p>Field Science should always store DO sensors in a moist or wet environment in order to prevent sensor drift. However, rehydrate DO sensors be left in dry air for longer than eight hours. To rehydrate, soak the DO</p>



Title: NEON Preventive Maintenance Procedure: AIS Surface Water Quality Multisonde		Date: 04/19/2022
NEON Doc. #: NEON.DOC.001569	Author: B. Nance, D. Monahan, M. Mahal, M. Cavileer	Revision: D

<i>Probe Sensor</i>	Storage Requirements
<i>Dissolved Oxygen Sensor Long-Term Storage</i>	<p>sensor cap in warm (room temperature) tap water for approximately 24 hours. Following this soak, calibrate the sensor and store it in a moist environment.</p> <p>Leave the sensor installed in the Multisonde, and submerge it in clean water in the calibration cup. Screw the cup on tightly to prevent evaporation. Field Science may also store the ODO sensor by itself in two ways. One, submerge the sensing end of the sensor in a container of water; occasionally check the level of the water to ensure that it does not evaporate. Two, store the sensor in water-saturated air. YSI does not recommend storing the sensor with the connector end unmated or exposed. If unmated, cover with plastic connector cap.</p>
<i>pH/ORP Sensor Short-Term Storage</i>	<p>Field Science Technicians should always store pH sensors in a moist or wet environment in order to prevent sensor drift. When in regular field use, the sensor should remain installed on the Multisonde in an environment of water-saturated air. Place approximately 0.5 in (1 cm) of water (tap or environmental only) or pH 4.00 calibration solution in the bottom of the calibration cup. Insert the Multisonde and sensor into the cup and screw it on tightly to prevent evaporation. Rehydrate pH sensor in pH 4 buffer, 24 hours prior to reinstallation.</p>
<i>pH/ORP Sensor Long-Term Storage</i>	<p>Remove the sensor from the Multisonde and insert its sensing end into the bottle (the sensor's original shipping materials). Install the bottle's O-ring and cap then tighten. This bottle contains a 2 molar solution of pH 4 buffer. If this bottle is not available, place the probe in a similar container. Do not store the pH or pH/ORP sensor in Zobell solution, DI or distilled water. Rehydrate pH sensor in pH 4 buffer, 24 hours prior to reinstallation.</p>

6.3.3 Packaging Requirements

Post-decontamination, package the sensor. Table 22 provides the shipping requirements for each probe sensor. Table 23 provides instructions on how to unpack a Multisonde probe to maintain the original packaging for use in sensor refresh.



6.3.3.1 Probe Sensor Shipping Requirements

For Sensor Refresh, only ship the probes with each asset tag. Do not send the wiper module or sensor body. The probes for Turbidity, Dissolved Oxygen (DO), Conductivity/ Temperature, Chlorophyll and fDOM (fluorescent dissolved organic matter) require annual Refresh. Ship each sensor with their asset tag using the following guidance in **Table 22**.

Table 22. Probe Sensor Shipping Requirements



Figure 135. General Probe Sensor Packaging for Shipping/Handling

See Section 6.3.3.2, Table 23. Reverse the instructions to package the Turbidity, Conductivity/ Temperature, Chlorophyll (Total Algae/Chla) and fDOM (fluorescent dissolved organic matter) sensor probes (**Figure 135**).



Figure 136. DO Sensor Probe Shipping Requirements

Ship the DO sensor using a sensor cap with a damp sponge (**Figure 136**) or in a plastic baggy/plastic wrap with a wet paper towel/cloth.

When receiving sensor cap, prior to installation, ensure the cap's container remains moist. Once the sensor cap is installed on the sensor, maintain this environment by placing approximately 0.5 in (1 cm) of water (deionized or distilled) in the bottom of the calibration cup and screw it tightly onto the Multisonde to prevent evaporation. You may also store the sensor by submerging the cap end in water.



Title: NEON Preventive Maintenance Procedure: AIS Surface Water Quality Multisonde		Date: 04/19/2022
NEON Doc. #: NEON.DOC.001569	Author: B. Nance, D. Monahan, M. Mahal, M. Cavileer	Revision: D



Figure 137. pH Probe Shipping Requirements

To ship the pH sensor, remove the sensor from the Multisonde and insert its sensing end into the bottle (the sensor’s original shipping materials) Install the bottle’s O-ring and cap then tighten. This bottle contains 2 molar solution of pH 4 buffer (Figure 137).

Ensure the O-ring on the bottle is securely seated and flush. Invert the bottle to test it for leaks (flip it upside down). If it leaks, remove the O-ring and reseal it correctly. Submit an incident caused by change ticket if the shipping materials leak regardless for additional guidance to proceed from CVAL.

6.3.3.2 Probe Sensor Packaging Guidance

Table 23 provides instructions on how to unpack a Multisonde probe to maintain the original packaging for use in sensor refresh.

Table 23. How to Unpack a Sensor Probe

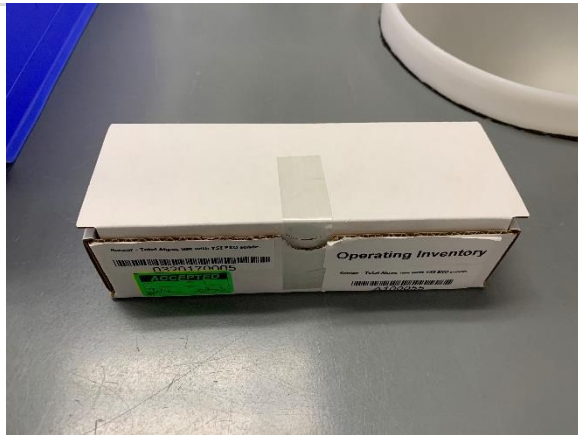

Figure 138. Sensor Packaging/Cardboard Box

STEP 1 | Open the sensor probe box (Figure 138) and remove the insert containing the sensor probe and asset tag.

STEP 2 | The following numbers correlate with the numbers in Figure 139.

1. This is what the sensor packaging looks like upon removal from its shipping container.
2. Flatten the two side flaps of the insert with the probe.
3. Expand the insert by pulling the two flaps beneath the probe out.



Figure 139. Remove the Sensor from the Box and Expand the Sides of the Cardboard Insert

STEP 3 | The following numbers correlate with the numbers in **Figure 140**.

1. Bring the two flaps upwards to add slack to the plastic covering surround the cardboard insert.
2. Pull the sensor and asset tag out.



Figure 140. Move the Sides of the Insert up to Create Slack in Plastic Packaging to Remove Sensor and Asset Tag

6.3.4 Shipping

Note: For any Non-CVAL initiated sensor returns, please notify CVAL of the return via the NEON program’s issue management and reporting system.

Complete an External Transfer Request (ETR), Bill of Lading and Site Manifest pack list per in accordance with RD [07] or via the Issue Management System and return to the NEON program HQ using the following address:

BATTELLE, ATTN: CVAL
1685 38TH STREET, SUITE 100
BOULDER, CO 80301

Only include sensors/subsystems for Sensor Refresh. Additional equipment must ship separately as they may require attention from other NEON HQ departments. Sensor refresh shipments go direct to CVAL. If sensors are shipping to HQ to address a trouble ticket, per guidance via the Issue Management System, return to the NEON program HQ using the following address with an ETR and a red defective tag:



Title: NEON Preventive Maintenance Procedure: AIS Surface Water Quality Multisonde		Date: 04/19/2022
NEON Doc. #: NEON.DOC.001569	Author: B. Nance, D. Monahan, M. Mahal, M. Cavileer	Revision: D

BATTELLE, **ATTN: REPAIR LAB**
 1685 38TH STREET, SUITE 100
 BOULDER, CO 80301

6.4 Sensor Refresh Record Management of Assets

In addition to the physical movement of devices, the sensor refresh process requires dedicated and accurate record management of asset movement and location. **Reference RD [07] for the standard operating procedures for the annual Sensor Refresh process and delineation of sensor, administrative and logistical requirements.**

6.4.1 NEON Asset Management and Logistic Tracking System Requirements

Field Science must update the instrumentation records via the NEON’s project Asset Management and Logistic Tracking System (MAXIMO). NEON HQ must maintain accurate record keeping on the location, date, and time offline of an instrument to ensure NEON HQ, Computer Infrastructure, Data Products, and CVAL are aware to apply the correct algorithms, calibrations, and processing factors. Reference RD [08] for additional information on Sensor Refresh administrative procedures. Ensure the CFG location reflects the current site of the sensor. All devices leaving a CFGLOC must move to SITE first, then DxxSUPPORT, and then TRANSIT.

The Multisonde is unique as it requires Field Science Technicians to manually install the Multisonde body and each sensor probe EEPROM ID into the associated CFGLOC in Maximo. The Multisonde body is only able to stream to the LC as one EEPROM ID, so the LC asks Maximo for the additional EEPROMS, and reassigns the incoming data by the individual probe EEPROM IDs. *See Section 9 for more information on the Multisonde configuration in Maximo.*

 **Note: In general, to minimize for CI, all devices leaving a CFGLOC must move to SITE first, then DxxSUPPORT, and then TRANSIT.**

 *Note: An important exception when assigning CFG locations are Grape data loggers. Grapes remain at the SITE level (a four-letter site code) or a more specific location within the hierarchy. Do not assign Grapes to a CFG location using the “CFGLOC” prefix. Grapes are data loggers and log data from sensors from specific CFG locations.*

After installation of the sensors, verify sensor data state of health (Data Product) in the [SAS report](#) (this report updates every 24 hours) and the IS Monitoring Suite (optional) the next day. Validate sensor data stream(s) and LO data are Active (in green).

6.4.2 Remote Connection Program Information Requirements

For AIS buoy sites, if there is a need to access LoggerNet™ (Profiler and MET Software) remotely (from the Domain or HQ), ENG must shut down the RTU program for the site (software that collects and transmits the data from the AIS Buoy to HQ). The RTU program uses the same port we would use to



<i>Title:</i> NEON Preventive Maintenance Procedure: AIS Surface Water Quality Multisonde		<i>Date:</i> 04/19/2022
<i>NEON Doc. #:</i> NEON.DOC.001569	<i>Author:</i> B. Nance, D. Monahan, M. Mahal, M. Cavileer	<i>Revision:</i> D

connect remotely to communicate with LoggerNet™. Generate a request via the NEON Issue Management/Reporting System to coordinate to contact the Software Engineers in the NEON HQ, Engineering Department. Otherwise, verify the Buoy sensor data from the Oz Grape using PuTTY (note the data streams are collected in bursts via radio transmission).



Title: NEON Preventive Maintenance Procedure: AIS Surface Water Quality Multisonde		Date: 04/19/2022
NEON Doc. #: NEON.DOC.001569	Author: B. Nance, D. Monahan, M. Mahal, M. Cavileer	Revision: D

7 ISSUE REPORTING OUTPUTS

Use this metadata sheet in **Table 24**. Multisonde Issue Reporting Datasheet to track and/or communicate maintenance tasks and findings by technician/site/date. Follow local paper-based and electronic record management procedures.

Table 24. Multisonde Issue Reporting Datasheet

Issue Reporting Datasheet		
Datasheet field	Entry	
Domain and Aquatic Site Code		
Maintenance Time and Date		
Maintenance Technician		
Preventive Maintenance	Issue Noted	Issue Summary
Cables & Connectors - Condition Check	<input type="checkbox"/>	
Multisonde Grape – Condition Check	<input type="checkbox"/>	
Multisonde Mount – Condition Check	<input type="checkbox"/>	
Multisonde External Surface and Anti-fouling components – Condition Check	<input type="checkbox"/>	
Multisonde Batteries – Condition Check	<input type="checkbox"/>	
Multisonde Probe Sensors – Condition Check	<input type="checkbox"/>	
Multisonde Probe Sensors – Cleaning	<input type="checkbox"/>	
Multisonde Probe Sensors – Calibrations	<input type="checkbox"/>	
Sensor - Other Specific Checks (<i>Sensor and cable ties are secure, no corrosion is occurring on the captive discs, etc.</i>)	<input type="checkbox"/>	
Environmental Information (<i>Any significant weather events occur that may correlate with the issue summary?</i>)	<input type="checkbox"/>	
Sensor Removal (<i>due to seasonal conditions such as significant freezing, ice heaving and accumulations, etc.</i>)	<input type="checkbox"/>	
Notes		

For Multisonde corrective actions, ensure proper tracking of the asset via the NEON Issue Management and Tracking System (i.e., ServiceNow) to establish a chain of custody of the asset between Engineering, Manufacturing and CVAL.

Conduct the following tasks to ensure the proper management of the asset between sites:



Title: NEON Preventive Maintenance Procedure: AIS Surface Water Quality Multisonde		Date: 04/19/2022
NEON Doc. #: NEON.DOC.001569	Author: B. Nance, D. Monahan, M. Mahal, M. Cavileer	Revision: D

1. For each issue where NEON, HQ is replacing a defective instrument/subsystem at an AIS site, create an incident and assign incident tasks to HQ personnel in the NEON Issue Management and Reporting System for the defective asset from the reported issue.
2. Ship all defective equipment/assets with a red "Rejected" tag. **Figure 141** displays the minimum information requirements for each tag.

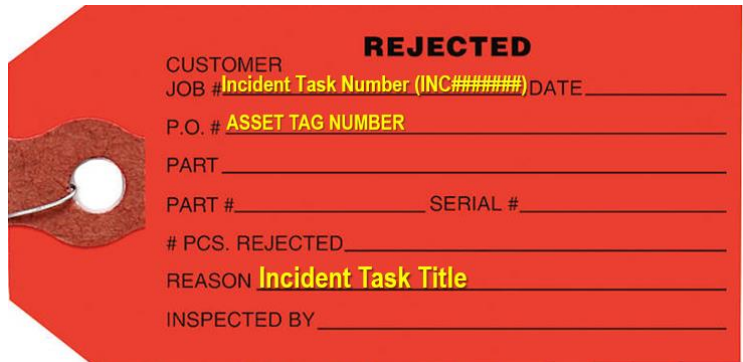

Figure 141. Red Rejected Tag for Defective Assets (MX104219)



8 FIELD CALIBRATION DATA TRANSMISSION INSTRUCTIONS

This procedure requires the IS Control and Monitoring Suite. Download this software via the following location: N:\Common\CVL\Field_Calibration\Required Directory\Test_Data\Current Executables\IS Control and Monitoring Suit (ensure you are running the most current version). This program is a BETA version and subject to change. Changes in the submission process will be communicated via ServiceNow.

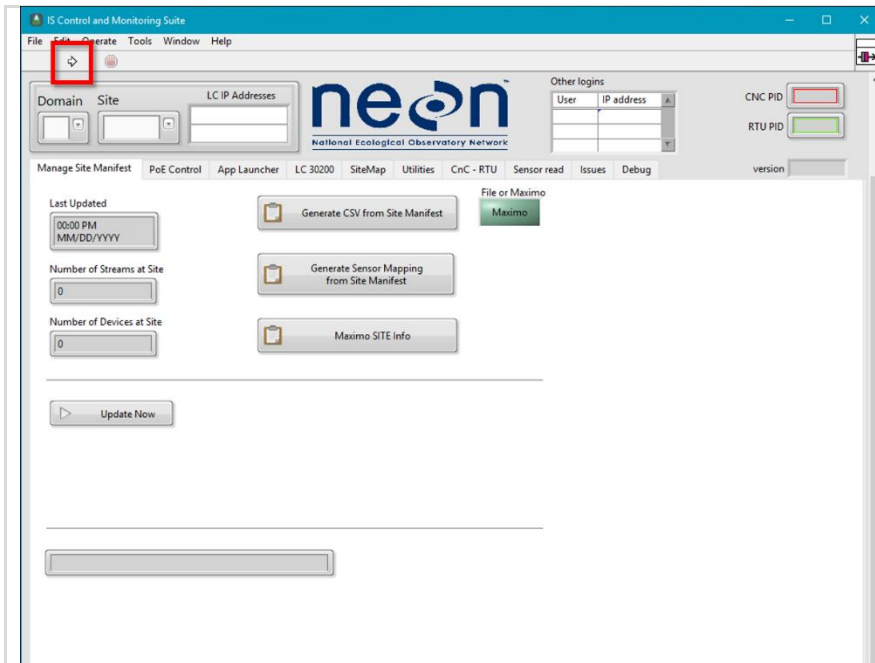

Figure 142. Select the Run Icon in the Upper Left Hand Corner

STEP 1 | Launch the IS Control and Monitoring Suite and select the Run icon in the upper left hand corner of the window (white arrow in Figure 142 and Figure 143).

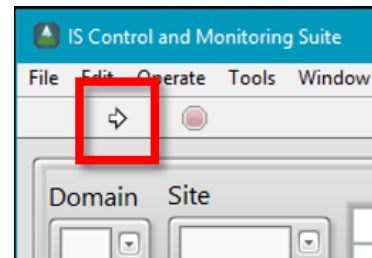

Figure 143. Close-up of Run Icon

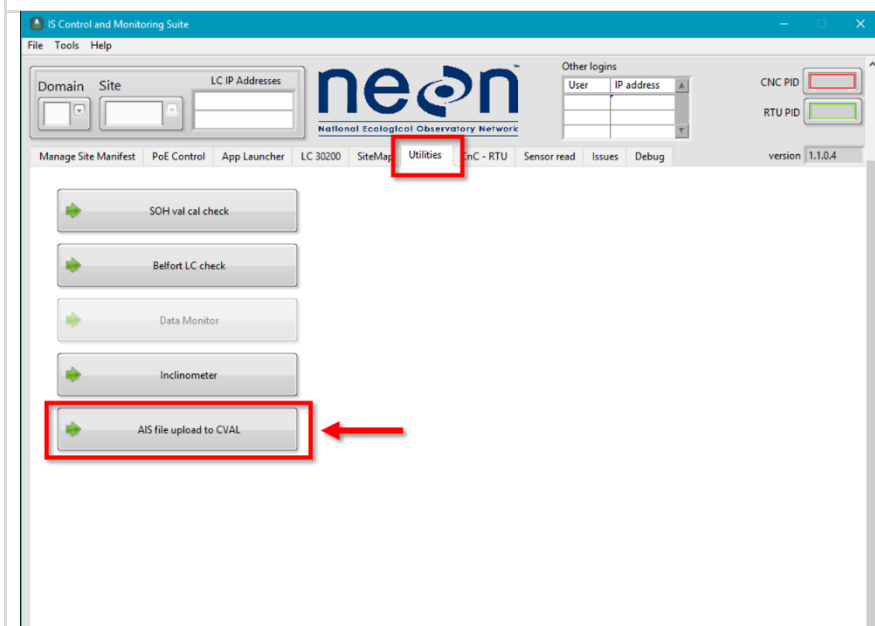

Figure 144. Navigate to the Utilities Tab and Select "AIS file upload to CVAL"

STEP 2 | Navigate to the Utilities tab and select "AIS file upload to CVAL" (Figure 144).

Note: This procedure does not require you to select your Domain or Site.

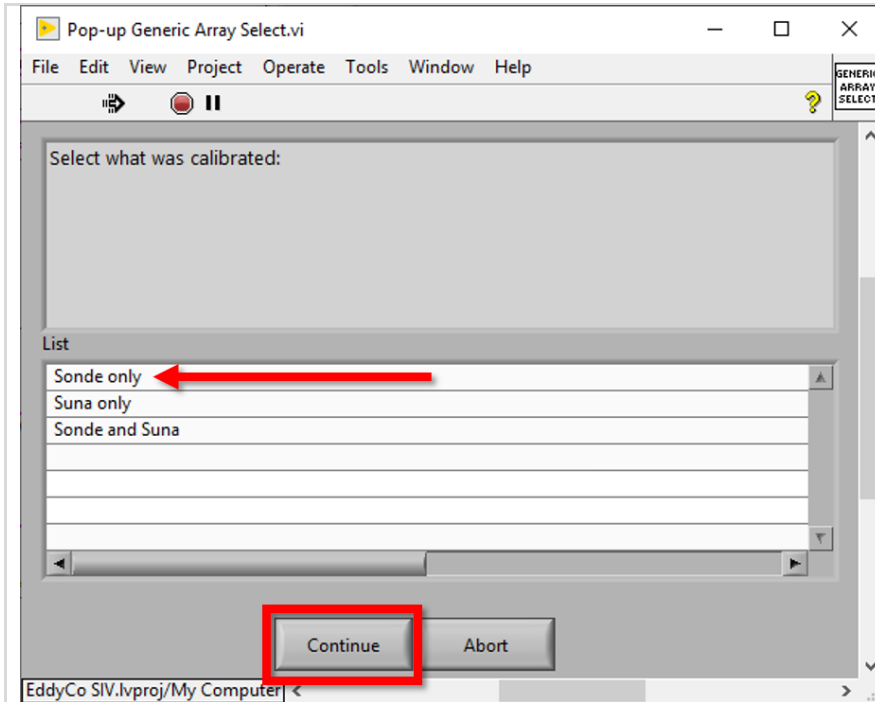



Figure 145. Select Sonde only to upload Multisonde Calibration Data Pop-up Window

STEP 3 | Select the **Sonde only** to upload the calibration data for the Multisonde (**Figure 145**). Click “**Continue**” to move to the next step.

 *Note: This procedure assumes you are calibrating the Multisonde (**Sonde only**); however, select the **Sonde and SUNA** option if you have calibration data for both the Multisonde and the SUNA (Nitrate Analyzer).*

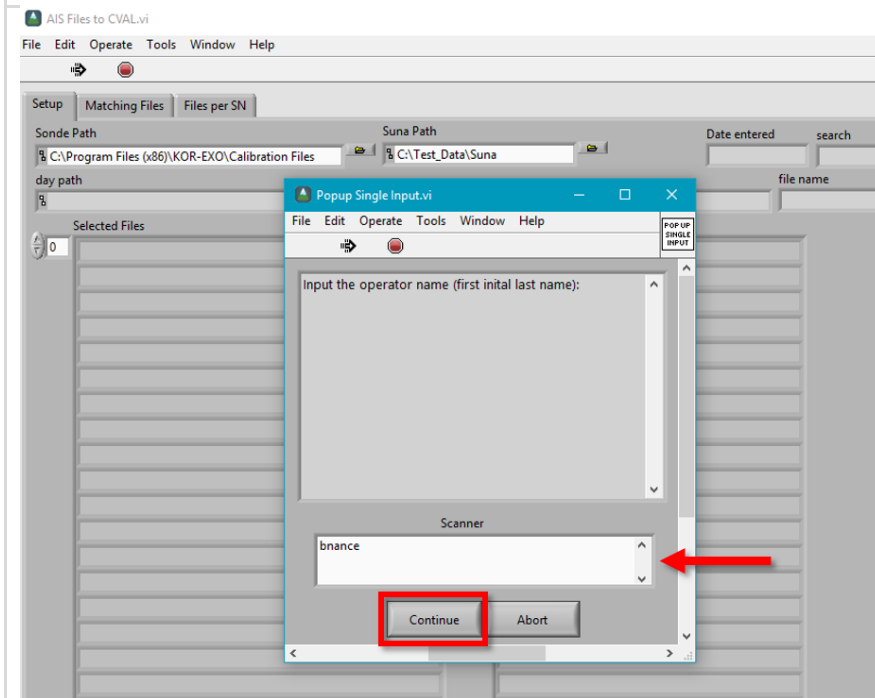

Figure 146. Input Operator Name

STEP 4 | Follow the prompts. Input operator name in the following order: **first initial last name (Figure 146)**. (Your Battelle Ecology username.)

Click “**Continue**” to move to the next pop-up window.

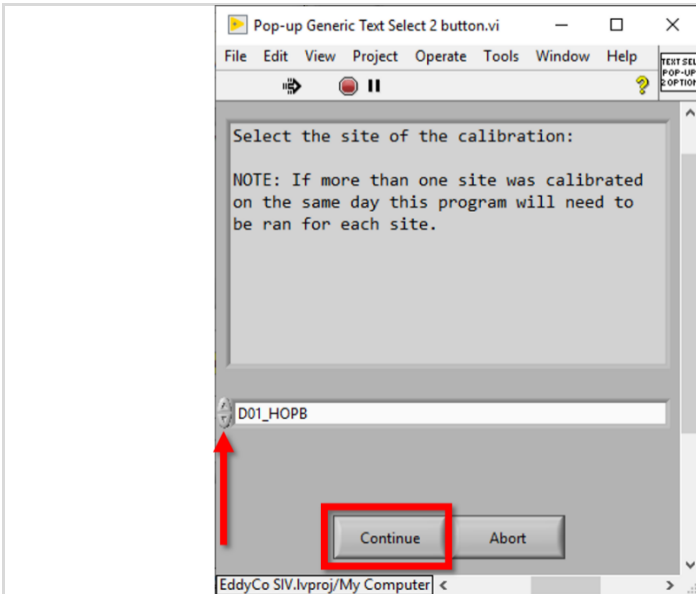



Figure 147. Select the Site of the Calibration Pop-up Window

STEP 5 | Select the site where you conducted the Multisonde calibrations from the dropdown (**Figure 147**). This example uses Domain 10 ARIK.

Click “**Continue**” to move to the next pop-up window.

 *Note: This program uploads calibration data from one site at a time. If you calibrated sensors from multiple sites, run the program from beginning to end for each site.*

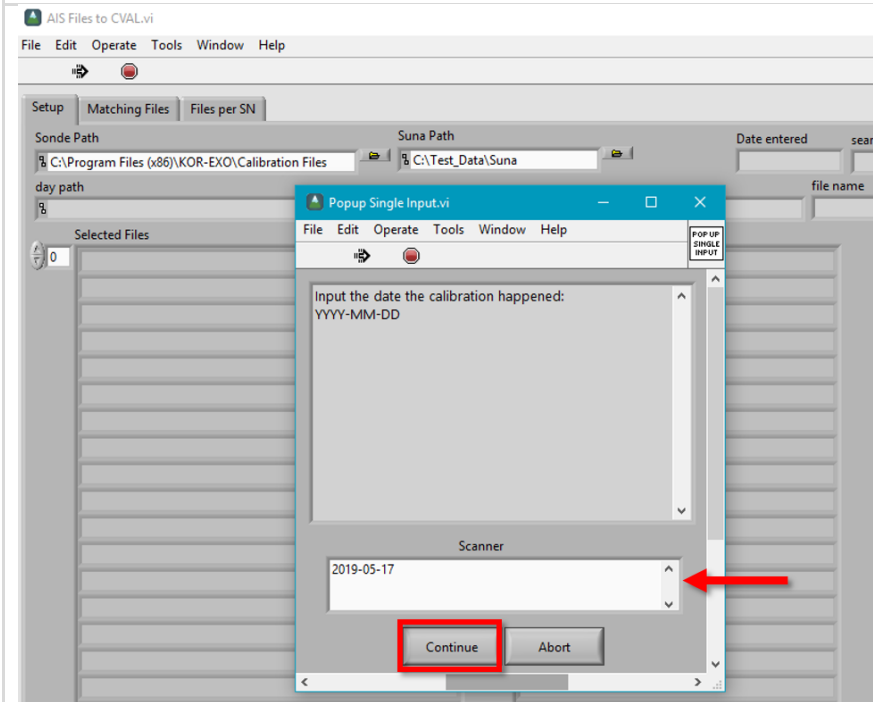

Figure 148. Input Date of Multisonde Calibration

STEP 6 | Input the date of the calibration in the following order: YYYY-MM-DD (**Figure 148**).

Click “**Continue**” to move to the next pop-up window.

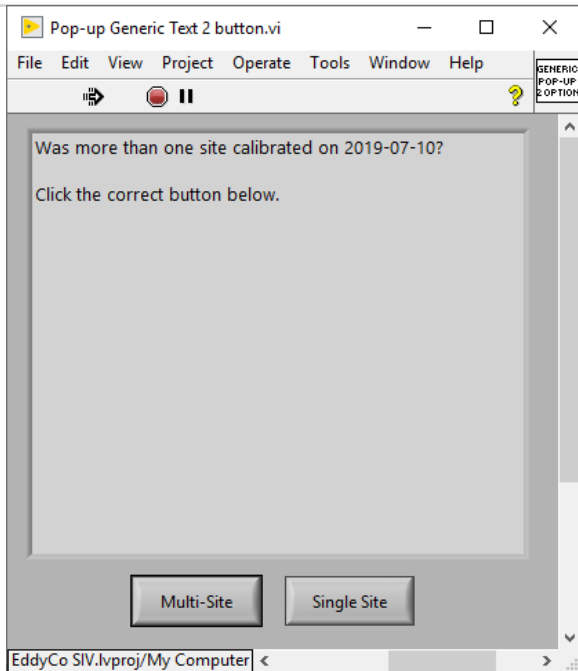

Figure 149. Select Multi-Site or Single Site

STEP 7 | If this is for two sites on the same day, select the **“Multi-Site”** button to select the sensor files for the site you selected in Step 5. You will need to do the same process again for the second site after you complete the first site’s file transfer process.

If this is for one site, select **“Single Site”**. The program automatically selects all the files from the same folder, so there is no need to self-select files to separate calibration files from sensors from two different sites.

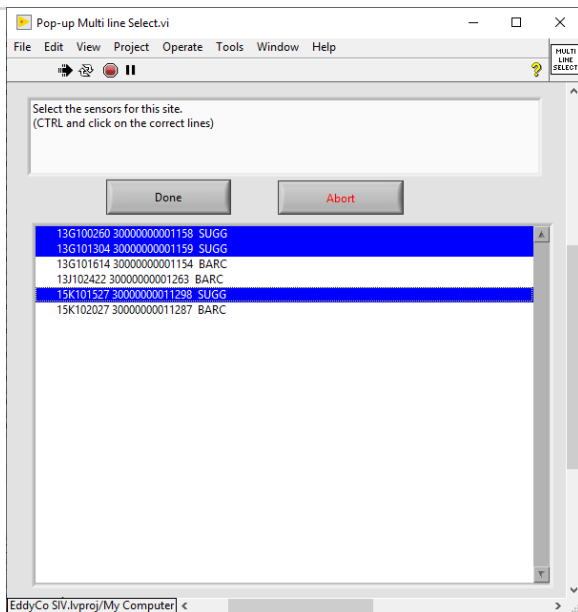

Figure 150. For the First Site, Select the Files for the Site You Identified in Step 5

STEP 7.1 | For Multi-Site Selection Only: Select the site files that match with the site selected in Step 5. Hold the **“Ctrl”** button on your keyboard and use your cursor to select the data files for the first site (**Figure 150**).

Verify the records are correct for the sensor and click **“Done”** after selecting all the files for the site.

*If you selected **“Single Site”**, you will not receive this pop-up window. **Disregard Step 7.1 and 7.2.***

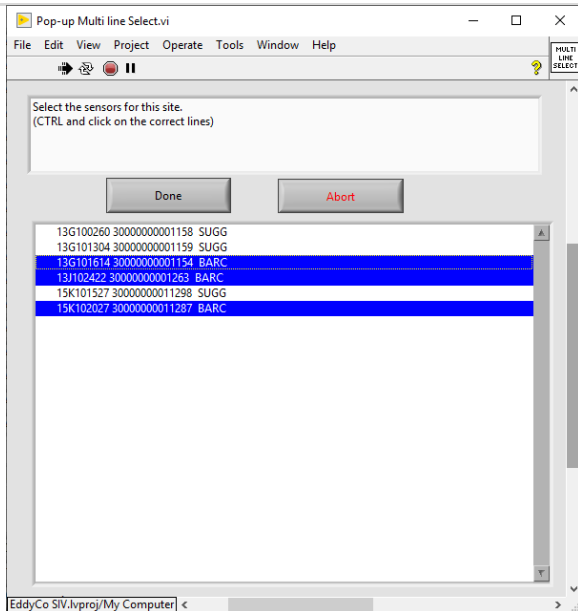

Figure 151. After Completing the Process for the First Site, Select the Remaining Files for the Second Site You Identified in Step 5

STEP 7.2 | For Multi-Site Selection Only:

After completing the process for the first site, conduct Steps 1-10 for the second site.

Select the data files for the second site using the same method in Step 9 (Figure 151).

Verify the records are correct for the sensor and click "Done" after selecting all the files for the second site.



Note: You will complete Step 7.2 after you complete this process for the first site and begin the process again for the second site. The program is only able to ingest files from one site at a time. Selecting the "Multi-Site" option allows the user to select files for the site identified in Step 5. Otherwise, the program automatically pulls all files from the same folder when users select "Single Site".

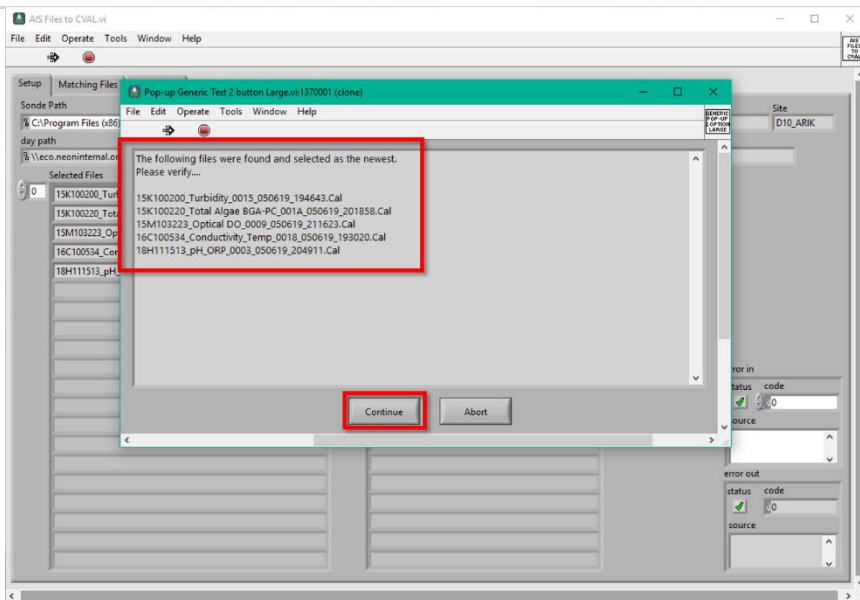

Figure 152. Upload Most Recent Calibration Files to CVAL

STEP 8 | The application displays a list of files to upload to CVAL (Figure 152). It uploads the most recent files. (If you had to conduct two calibrations on a probe, it will take the most recent calibration file.) If you conducted calibrations from sensors at two different sites, it will show your selection of site files.

Verify the list in the pop-up window and select "Continue" to move to the next window.

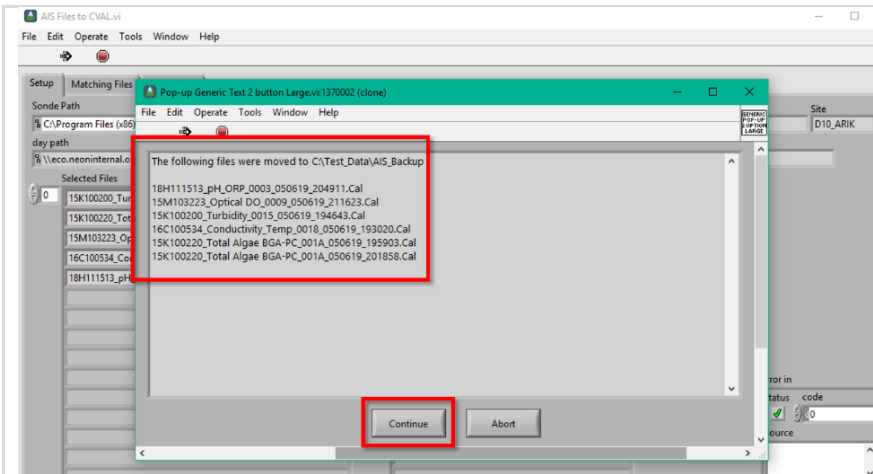

Figure 153. Archival of Kor Calibration Files on C Drive

STEP 7 | This screen displays the files that the application moves from the Kor folder to an Archive folder on the C Drive. Notice in **Figure 153**, there are two files for Chlorophyll. That is because the probe sensor failed its initial calibration.

Select **“Continue”** to complete the Multisonde calibration file transfer/upload process.

STEP 8 | Click on the **“X”** to exit the application (**Figure 154**).

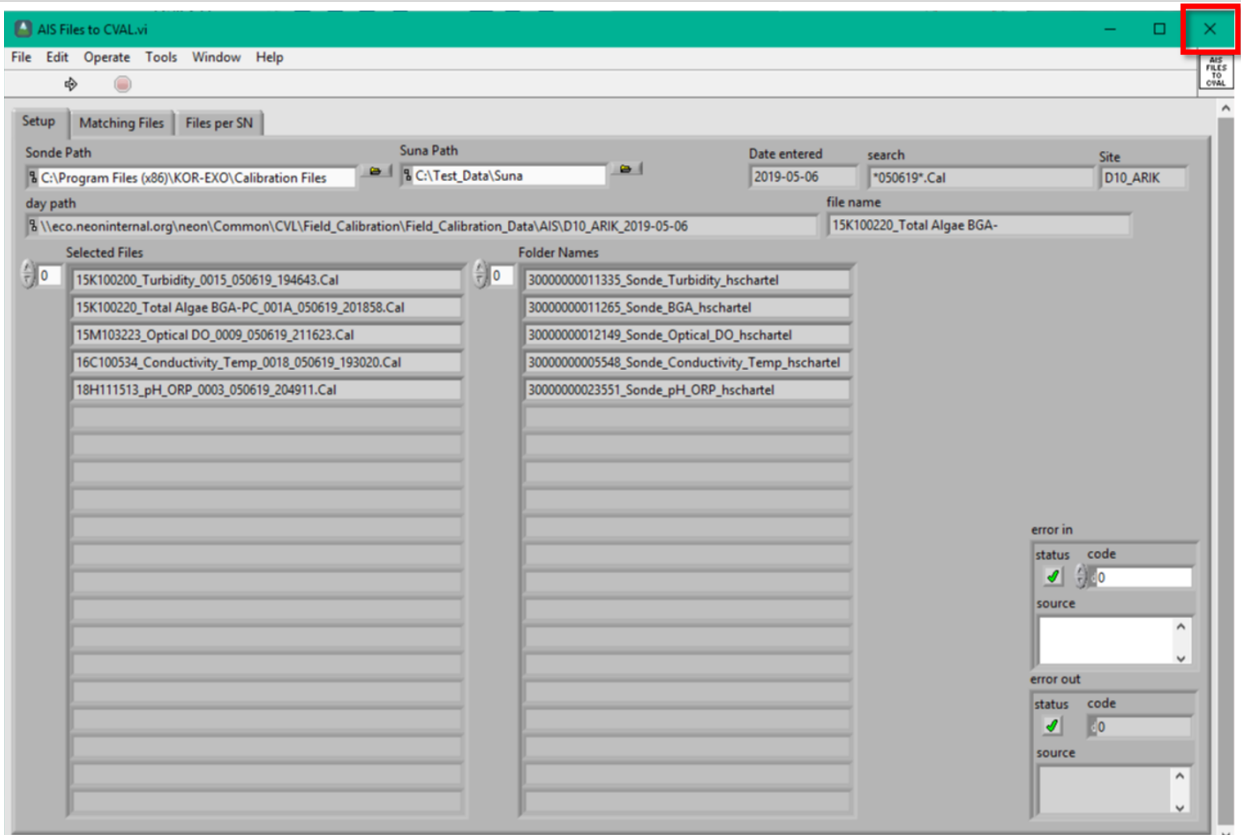

Figure 154. Click the "X" to Exit the Application

Following this procedure, the calibration files are stored on the Network Drive in the following folder:
N:\Common\CVL\Field_Calibration\Field_Calibration_Data\AIS

They files reside in this folder until ingest (which occurs monthly). After ingest, they transfer to an archive folder for future reference: **N:\Common\CVL\Field_Calibration\Field_Calibration_Data\Archive\AIS**



Title: NEON Preventive Maintenance Procedure: AIS Surface Water Quality Multisonde		Date: 04/19/2022
NEON Doc. #: NEON.DOC.001569	Author: B. Nance, D. Monahan, M. Mahal, M. Cavileer	Revision: D

There are Backup files available to access via local C drive, wherever you have the "Test_Data" folder:
C:\Test_Data\AIS_Backup

 *Note: The program automatically combines the same date/sites files into one folder, if files transfer from more than one computer.*



9 MULTISONDE CONFIGURATION IN MAXIMO

The Multisonde data streams are viewable (and ACTIVE) in the SAS Report when the Multisonde body and each probe sensor are installed in an accurate CFGLOC in Maximo. Generally, sensors stream from a single EPROM ID (or EEPROM) programmed into a one-wire chip in the cable attached to the sensor (Figure 155).

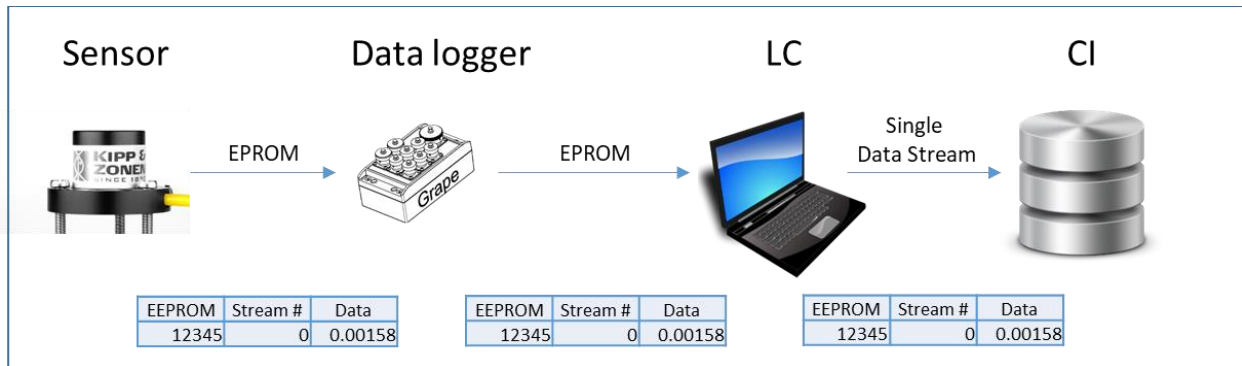

Figure 155. How a Sensor Streams with a Single EPROM ID

The Multisonde EPROM ID configuration is unique. Since we can only program a one-wire chip with one EPROM ID, the Multisonde streams to the LC under one assembly level EPROM ID. This acts as a higher-level or parent EPROM ID. This is why it is important to keep the Multisonde body and cable in their original location. It avoids having to reprogram the one-wire chip and Multisonde configuration.

Each sensor probe on the Multisonde has their own EPROM ID, but it is not programmed into the one-wire chip. The site LC queries Maximo for the separate probe sensor EPROM IDs. Then it reassigns the incoming data streams by individual sensor EPROM ID and stream number (Figure 156).

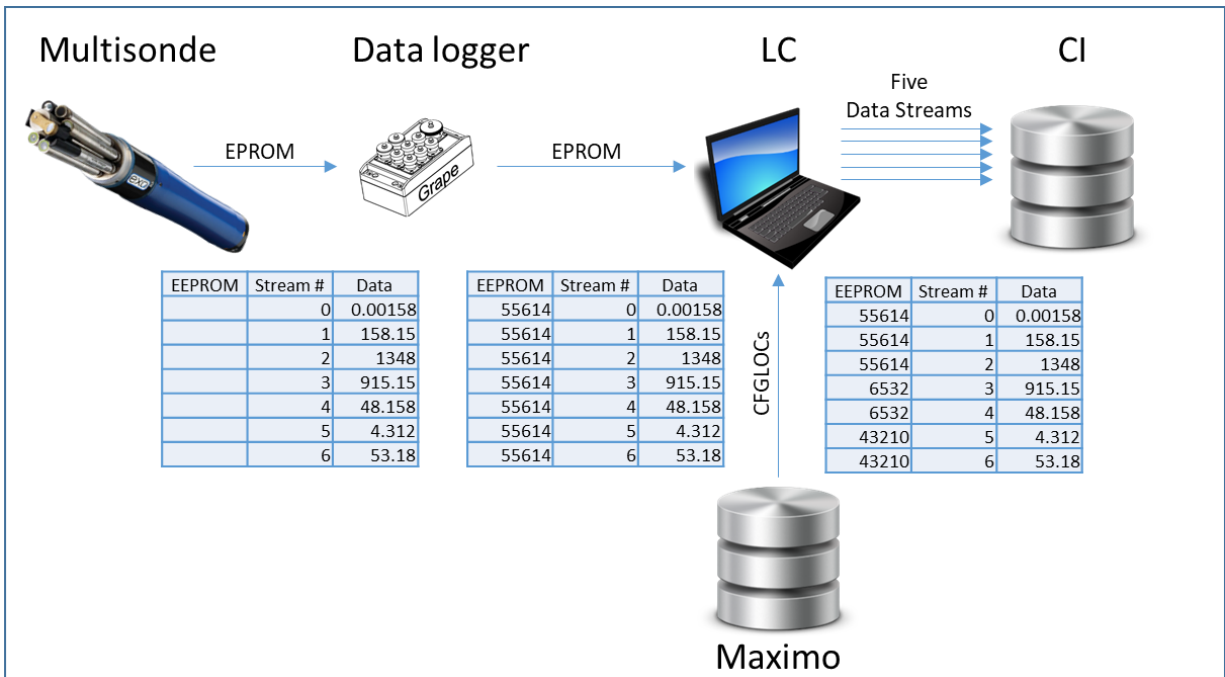

Figure 156. How a Multisonde Streams with Multiple EPROM IDs

Therefore, if the probe sensors on the Multisonde are not installed in Maximo under the correct CFGLOC, these data streams will not show up in the SAS Report, and other remote monitoring applications, or as a data product for the data portal.

Table 25 displays the configuration for the Multisonde’s 15 data streams at S1 and S2, and 18 data streams via our buoys. If the data streams are out of order, the incoming data from the probes is garbage/lost, and we fail to deliver quality Multisonde data products for the scientific community.

Table 25. Multisonde Data Stream Configuration

Data Stream	In-Stream Sonde	Buoy Sonde
1	Cond (uS/cm)	Cond (uS/cm)
2	SpCond (uS/cm)	SpCond (uS/cm)
3	Temp (C)	Temp (C)
4	Depth (m)	Depth (m)
5	Pressure-Abs (psia)	Pressure-Abs (psia)
6	DOsat (%)	DOsat (%)



Title: NEON Preventive Maintenance Procedure: AIS Surface Water Quality Multisonde		Date: 04/19/2022
NEON Doc. #: NEON.DOC.001569	Author: B. Nance, D. Monahan, M. Mahal, M. Cavileer	Revision: D

Data Stream	In-Stream Sonde	Buoy Sonde
7	DOsat (%) Local	DOsat (%) Local
8	DO (mg/L)	DO (mg/L)
9	pH (pH)	pH (pH)
10	pH (mV)	pH (mV)
11	Turbidity (FNU)	BGA PC (ug/L)
12	fDOM (QSU)	Chl (ug/L)
13	Wiper Position (V)	Chl (RFU)
14	Battery Voltage (V)	Turbidity(FNU)
15	Sonde Cable Power (V)	fDOM (QSU)
16		Wiper Position (V)
17		Battery voltage (V)
18		Sonde Cable Power (V)

All of the streams will show up as the Multisonde assembly's EPROM ID (all 15 or 18 depending on the site), even if there are no specific probes installed in Maximo. This may appear OK, but it is not OK. Our data ingestion process is looking for specific EPROM IDs to parse out each stream by its probe sensor in order to ingest the data. This means that even though the Multisonde will still stream all 15 data streams under the Multisonde assembly EPROM ID, it is not streaming correctly for our data pipeline. For example, a specific probe sensor, such as Conductivity, will display as INACTIVE in SH if a known EPROM ID is not assigned by its CFGLOC via Maximo. **Therefore, it is imperative Field Science assigns each probe under the correct CFGLOC in Maximo immediately after installing new probes after Sensor Refresh or when replacing a defective probe.**

 *Note: If you did not move the old probes out of the CFGLOCs and SITE level location (the four-letter name for your site, BLDE for example), the old probes will continue to stream until the new probes are installed into the correct Maximo site level CFGLOCs. Ensure the old probe sensors are moved to the DOMAIN level in Maximo to prevent collecting garbage data.*



Title: NEON Preventive Maintenance Procedure: AIS Surface Water Quality Multisonde		Date: 04/19/2022
NEON Doc. #: NEON.DOC.001569	Author: B. Nance, D. Monahan, M. Mahal, M. Cavileer	Revision: D

 *Note: If you ever replace your Multisonde body for any reason (currently not planned), you need to contact someone at HQ (engineering) to remotely update the EPROM ID in your sites installed Multisonde cable. Submit a ticket in ServiceNow and if there are no responses within 24 hours, follow up by calling the Engineering Service Line: 720-836-2470.*



Title: NEON Preventive Maintenance Procedure: AIS Surface Water Quality Multisonde		Date: 04/19/2022
NEON Doc. #: NEON.DOC.001569	Author: B. Nance, D. Monahan, M. Mahal, M. Cavileer	Revision: D

10 WIPER MAINTENANCE AND CALIBRATION

10.1 Quarterly/Annual maintenance

Refer to NEON.DOC.005039 for directions on quarterly o-ring replacement and annual maintenance.

10.2 Calibration

Occasionally the wiper will drift away from the set parking position. When this occurs, calibrate the wiper within KOR software to return to original position. If the wiper frequently drifts from normal position, request replacement.

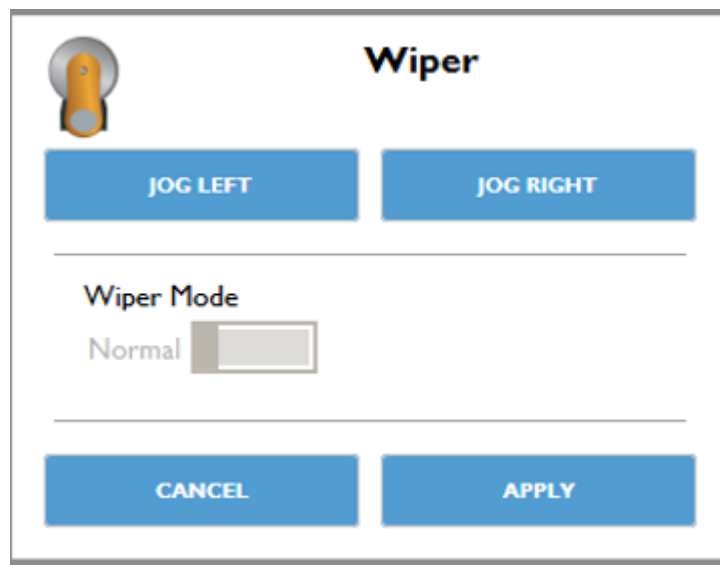

Figure 157. When calibrating wiper, click left/right to adjust.

10.3 Troubleshooting

When noticing erratic wiper data, troubleshooting is required. Normal wiper positional data will be a consistent value near 1.20v. When the wiper creates data outside that range (**Figure 158**), either the wiper is not parking in the correct place or the unit needs replacement.



Title: NEON Preventive Maintenance Procedure: AIS Surface Water Quality Multisonde		Date: 04/19/2022
NEON Doc. #: NEON.DOC.001569	Author: B. Nance, D. Monahan, M. Mahal, M. Cavileer	Revision: D

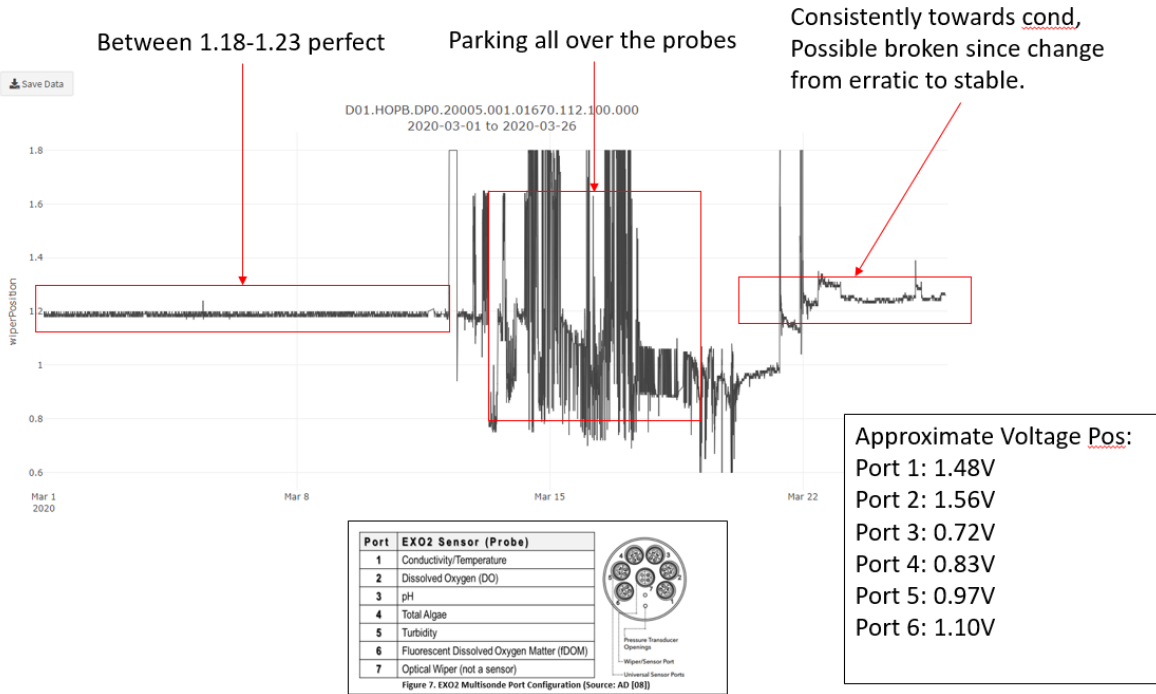

Wiper data is a snapshot of parking position, not indicating actually movement or action of wiper

Figure 158. Diagram of wiper data assessment.