



Title: NEON Preventive Maintenance Procedure: Submersible Ultraviolet Nitrate Analyzer (SUNA)		Date: 03/22/2022
NEON Doc. #: NEON.DOC.002716	Author: R. Willingham, M. Cavileer, J. Csavina, D. Monahan, B. Hensley	Revision: D

NEON PREVENTIVE MAINTENANCE PROCEDURE: SUBMERSIBLE ULTRAVIOLET NITRATE ANALYZER (SUNA)

PREPARED BY	ORGANIZATION	DATE
Bobby Hensley	AQU	9/11/2019
Jesse Vance	AQU	07/25/2017
Dylan Monahan	AQU	08/30/2018
Janae Csavina	CVAL	07/25/2017
Rachael Willingham	ENG	08/14/2018
Madeline Cavileer	ENG	02/19/2020

APPROVALS	ORGANIZATION	APPROVAL DATE
Kate Thibault	SCI	03/22/2022

RELEASED BY	ORGANIZATION	RELEASE DATE
Tanisha Waters	CM	03/22/2022

See configuration management system for approval history.



Title: NEON Preventive Maintenance Procedure: Submersible Ultraviolet Nitrate Analyzer (SUNA)		Date: 03/22/2022
NEON Doc. #: NEON.DOC.002716	Author: R. Willingham, M. Cavileer, J. Csavina, D. Monahan, B. Hensley	Revision: D

Change Record

REVISION	DATE	ECO #	DESCRIPTION OF CHANGE
A	09/14/2017	ECO-02640	Initial Release
B	01/03/2019	ECO-05799	Updates to graphics, formatting, grammar, and removed references to JIRA. Incorporated feedback from FOPS and HQ personnel. Incorporated updates to Section 2, Section 5, Section 6 and Appendices. Renamed Field Calibration Procedures to Field/Domain Calibration Validation Procedures. (The manufacturer for the SUNA calibrates the sensor. The field conducts validations on calibrated SUNA sensors.) Added adjusting the SUNA position to meet AIS science requirements during seasonal variability. Decreased Reference Spectrum updates from biweekly to monthly. The SUNA software SUNACom is now UCI; updated sections to reflect software GUI changes. Expanded on removal/reinstall instructions.
C	03/12/2020	ECO-06391	Updates include document template, changes in terminologies (NEON project to program and FOPS to Field Science), edits to sensor overview section, correction of Light:dark configuration in screenshots to 20:1 frames, and additional parameters to check in self-test. Incorporated two new appendices (Appendix D and E) for data monitoring and retrieving previous cal files per INC0031743. Removed references to the SAS report and replaced with PuTTY, DQ Blizzard, and IS Monitoring and Control Suite. Added NEON.DOC.005227 (AD [12]) as a reference in Section 2, updated DI water requirements in Section 5.4.1, and lastly, provided updated science guidance: Instead of automatically removing the sensor for a broken wiper or failed reference spectrum update, Field Science is to contact the AQU Science Team for further evaluation.
D	03/22/2022	ECO-06793	<ul style="list-style-type: none"> • Minor formatting updates



Title: NEON Preventive Maintenance Procedure: Submersible Ultraviolet Nitrate Analyzer (SUNA)		Date: 03/22/2022
NEON Doc. #: NEON.DOC.002716	Author: R. Willingham, M. Cavileer, J. Csavina, D. Monahan, B. Hensley	Revision: D

TABLE OF CONTENTS

1 DESCRIPTION..... 1

1.1 Purpose..... 1

1.2 Scope..... 1

2 RELATED DOCUMENTS AND ACRONYMS..... 2

2.1 Applicable Documents..... 2

2.2 Reference Documents..... 2

2.3 External References..... 3

2.4 Acronyms..... 3

3 SAFETY AND TRAINING 4

4 SENSOR OVERVIEW 5

4.1 Description..... 5

4.2 Handling Precautions..... 6

4.2.1 Sensor Handling Precautions..... 6

4.2.2 Subsystem Handling Precautions..... 6

4.3 Operation..... 6

4.4 Theory of Absorbance Measurements..... 7

5 INSPECTION AND PREVENTIVE MAINTENANCE10

5.1 Equipment.....10

5.2 Subsystem Location and Access.....11

5.2.1 Wadeable Stream Sites.....11

5.2.2 Lake and River Sites.....13

5.3 Maintenance Procedure.....15

5.3.1 Preventative Maintenance Procedure Sequence Overview.....16

5.3.2 Remote Monitoring.....17

5.3.3 Visual Inspections.....18

5.3.4 Bulkhead Connectors and Cable Maintenance.....19

5.4 Field Validation Procedures (Drift Test).....19

5.4.1 Sensor Deionized (DI) Water Requirements.....19

5.4.2 Connect to SUNA.....22



Title: NEON Preventive Maintenance Procedure: Submersible Ultraviolet Nitrate Analyzer (SUNA)		Date: 03/22/2022
NEON Doc. #: NEON.DOC.002716	Author: R. Willingham, M. Cavileer, J. Csavina, D. Monahan, B. Hensley	Revision: D

5.4.3 Configure & Prepare SUNA.....30

5.4.4 Conduct SUNA Drift Test.....33

5.4.5 Revert SUNA Configuration.....35

5.4.6 Available Lamp Time Verification.....39

5.4.7 Sensor Clock Synchronization.....39

5.4.8 Sensor Configuration Verification41

5.4.9 SUNA Self-Test.....42

5.5 [CRITICAL PROCEDURE] Disconnect SUNA from Software and Hardware44

5.6 Monthly Validation/Calibration Procedure.....46

 5.6.1 Monthly Calibration: Reference Spectrum Update Procedure.....46

5.7 Seasonal Maintenance (Stream Sites).....50

6 REMOVAL AND REPLACEMENT (SUBSYSTEM ONLY).....53

6.1 Equipment53

6.2 Removal and Replacement Procedure.....53

 6.2.1 Stream (S2) Sites.....54

 6.2.2 Lake and River AIS Buoy Sites.....60

6.3 Cleaning & Packaging of Returned Sensor.....60

 6.3.1 Decontamination60

 6.3.2 Storage.....60

 6.3.3 Packaging61

6.4 Sensor Refresh Record Management of Assets.....62

 6.4.1 NEON Asset Management and Logistic Tracking System Requirements62

 6.4.2 Remote Connection Program Information Requirements.....63

7 ISSUE REPORTING OUTPUTS64

8 APPENDIX A: PREVENTATIVE MAINTENANCE QUALITY ASSURANCE DATASHEET.....66

9 APPENDIX B: REMOTE CONNECTION & BASIC TROUBLESHOOTING.....67

10 APPENDIX C: SUNA POWER CABLE ASSEMBLY DRAWING70

11 APPENDIX D: MONITORING SUNA DATA FOR PROBLEMS.....71

12 APPENDIX E: RETRIEVING PAST CALIBRATION FILES.....77

13 SOURCES.....78



Title: NEON Preventive Maintenance Procedure: Submersible Ultraviolet Nitrate Analyzer (SUNA)		Date: 03/22/2022
NEON Doc. #: NEON.DOC.002716	Author: R. Willingham, M. Cavileer, J. Csavina, D. Monahan, B. Hensley	Revision: D

LIST OF TABLES AND FIGURES

Table 1. Preventative Maintenance Equipment10

Table 2. SUNA Preventative Maintenance Tasks Interval Schedule15

Table 3. Components Requiring Visual Inspections.....18

Table 4. How-To: Connect SUNA for Field Validation Process.....22

Table 5. Drift Check Preparation: Switch Operational Mode & Disable Wiper30

Table 6. Collect Pre-Cleaning DI Blank Nitrate Reading Procedure33

Table 7. Test Wiper Function & Restore Original SUNA Settings for Measurement Collection36

Table 8. Synchronize SUNA Internal Clock to UTC39

Table 9. How to Verify Sensor Configuration41

Table 10. How to Conduct a SUNA Self-Test.....42

Table 11. How to Properly Disconnect from a SUNA.....44

Table 12. Monthly Calibration Validation: Reference Spectrum Update Procedure46

Table 13. Seasonal Maintenance: Stream Flow Changes51

Table 14. Equipment for Sensor and Subsystem Removal and Replacement53

Table 15. SUNA Removal & Replacement Procedures for Stream Sites.....54

Table 16. SUNA Issue Reporting Datasheet64

Table 17. Preventative Maintenance Quality Assurance Datasheet.....66

Table 18. How to Connect to the SUNA with Putty.....67

Table 19. Verifying SUNA Configuration Settings Remotely69

Figure 1. Sea-Bird Scientific SUNA V2 with Integrated Anti-Fouling Wiper 5

Figure 2. Overview of How a Spectrometer, such as the SUNA, Creates Absorbance Measurements 8

Figure 3. S2 Downstream Location: SUNA on an Anchor with Subsystem Components at a Low Water Site.....12

Figure 4. Stream Stand-Alone Arbors (left, middle) and Device Post Arbor (far right)13

Figure 5. AIS Buoy for Lake and River Sites.....13

Figure 6. Dual SUNA PAR Mount and Radio Box on AIS Buoy14

Figure 7. SUNA Location on AIS Buoy for D03, FLNT14

Figure 8. Aquatic Portal Precip DIN Rail: AIS Buoy Portal Radio/Oz Grape Subsystem15

Figure 9. Examples of Damage to Report.....18

Figure 10. Lubricated Sockets for SUNA Bulkhead Connector.....19

Figure 11. DI Water Minimum Requirements: ATSM Type II20

Figure 12. Alternate Setups for DI Water Temperature Equilibration21

Figure 13. NEON Custom Y-Cable for Stream, Lake and River SUNA Field Validations/Calibrations (HB09780000).....22

Figure 14. Disconnect the SUNA 12V Merlot Grape.....23

Figure 15. SUNA Radio Box on AIS Buoy: Power Connector (12-10).....23

Figure 16. SUNA Bulkhead Connector24



Title: NEON Preventive Maintenance Procedure: Submersible Ultraviolet Nitrate Analyzer (SUNA)		Date: 03/22/2022
NEON Doc. #: NEON.DOC.002716	Author: R. Willingham, M. Cavileer, J. Csavina, D. Monahan, B. Hensley	Revision: D

Figure 17. SUNA Mount and Enclosure in Stream Locations.....24

Figure 18. SUNA in Cage on Dual PAR SUNA Mount on the Buoy.....25

Figure 19. Connect the SUNA to the Y Cable.....25

Figure 20. Functional Diagram of Y-Cable Connections for Validation Process25

Figure 21. Attach Y-Cable to the Merlot Grape at Stream Sites26

Figure 22. Attach Y-Cable to SUNA Radio Box at Buoy Sites26

Figure 23. Attach USB Connector to Laptop26

Figure 24. Example of Complete Setup for SUNA Validations.....27

Figure 25. Select Connect.....27

Figure 26. 57600 for Wadeable Stream Sites and 115200 for AIS Buoy Sites28

Figure 27. Connect Pop-up Window to Select Baud Rate and COM Port28

Figure 28. Select Connect.....29

Figure 29. Successful Connection to SUNA.....29

Figure 30. Configure SUNA for Validation Process.....30

Figure 31. Physically Move Wiper on SUNA.....31

Figure 32. Cut Parafilm to Size31

Figure 33. Wrap Parafilm around Optical Area of SUNA.....32

Figure 34. Fill Optical Area with Equilibrated DI Water.....32

Figure 35. Validate SUNA Vertically to Prevent Bubbles on Optical Bench.....32

Figure 36. Press Start on the SUNA Dashboard.....33

Figure 37. Collect Data for 1 Minute Monitoring the Wavelength Measurement34

Figure 38. After 1 Minute, Click Stop.....34

Figure 39. Record Real-Time Nitrate Measurement in Lower Left Corner35

Figure 40. Select "Check Wiper".....36

Figure 41. Select "Test" to Verify Wiper Function.....36

Figure 42. Monitor Wiper Movement36

Figure 43. Select "OK" to Complete Wiper Test37

Figure 44. Select "SUNA Settings".....37

Figure 45. Return SUNA to Original Settings for Deployment38

Figure 46. SUNA Dashboard: Available Lamp Time | Verify Lamp Time is > 50 Hours.....39

Figure 47. Use the "Sensor" Dropdown to Select "Set Clock"40

Figure 48. Select "Sync Time" to Automatically Update the SUNA Clock.....40

Figure 49. Open Command Terminal Window41

Figure 50. Select "get --cfg" from the Dropdown Command Prompt.....41

Figure 51. Configuration Output.....42

Figure 52. Open Command Terminal Window42

Figure 53. Select "SelfTest" in the Terminal Window43

Figure 54. "SelfTest" Output Populates in the Terminal Window43

Figure 55. In SUNA Dashboard, select "Disconnect"44

Figure 56. Confirm Connection Mode is Disconnected.....45



Title: NEON Preventive Maintenance Procedure: Submersible Ultraviolet Nitrate Analyzer (SUNA)		Date: 03/22/2022
NEON Doc. #: NEON.DOC.002716	Author: R. Willingham, M. Cavileer, J. Csavina, D. Monahan, B. Hensley	Revision: D

Figure 57. Click on the “Reference Update” on SUNA Dashboard46

Figure 58. Reference Update Wizard Step 1 of 4: Fill the Sampling Volume with DIWs47

Figure 59. Reference Update Wizard Step 2 of 4: Acquiring Spectra Data from SUNA47

Figure 60. Reference Update Wizard Step 3 of 4: Compare New Reference Spectrum to Current48

Figure 61. Reference Update Wizard Step 4 of 449

Figure 62. N:\Common\CVL\Field_Calibration\Field_Calibration_Data\AIS.....49

Figure 63. 30000000015530_SUNA_mpursley.....50

Figure 64. Dry Stream Bed – SENSOR REMAINS IN DRY STREAM51

Figure 65. SUNA Partially Submerged in Stream51

Figure 66. Winter Season Ice Accumulation52

Figure 67. NEON.D07.LECO.DP1.20002 High Flow Events.....52

Figure 68. AIS Combination Box - 5 Amp Breakers.....54

Figure 69. SUNA 12V Merlot Grape Subsystem.....55

Figure 70. Remove the 2 Bolts that Attach the Mount55

Figure 71. Do Not Remove these 4 Bolts.....56

Figure 72. Remove SUNA PVC Enclosure.....56

Figure 73. SUNA Orientation and Installation Components.....57

Figure 74. Pull 4 Lock Pins to Remove Captive Discs57

Figure 75. Remove Sensor from PVC Enclosure.....58

Figure 76. S2 SUNA Enclosure at D18 OKSR.....58

Figure 77. Reconnect Sensor Cable and Ethernet Cable to Grape59

Figure 78. SUNA Cable Dressing - Complete Installation.....59

Figure 79. Example of SUNA for Shipping/Storage.....61

Figure 80. Red Rejected Tag for Defective Assets (MX104219).....65

Figure 81. Connect to SUNA via Putty Serial Connection68

Figure 82. SUNA Power Cable Drawing.....70

Figure 83. SUNA Power Cable Wiring70

Figure 84. Process to Manually Download SUNA Calibration Files.....77

Figure 85. Default File Location Setup in UCI77



Title: NEON Preventive Maintenance Procedure: Submersible Ultraviolet Nitrate Analyzer (SUNA)		Date: 03/22/2022
NEON Doc. #: NEON.DOC.002716	Author: R. Willingham, M. Cavileer, J. Csavina, D. Monahan, B. Hensley	Revision: D

1 DESCRIPTION

1.1 Purpose

Routine preventive maintenance is imperative to ensure the proper functional and operational capability of National Ecological Observatory Network (NEON) systems, and the preservation of NEON infrastructure. This document establishes mandatory procedures and recommended practices for preventive maintenance of the **Submersible Ultraviolet Nitrate Analyzer (SUNA)** to meet the objectives of the NEON program, and its respective stakeholders and end users.

1.2 Scope

Preventive Maintenance is the planned maintenance of infrastructure and equipment with the goal of improving equipment life by preventing excess depreciation and impairment. This maintenance includes, but is not limited to, inspecting, adjusting, cleaning, clearing, lubricating, repairing, and replacing, as appropriate. The procedures in this document are strictly preventive and do **not** address corrective actions.



Title: NEON Preventive Maintenance Procedure: Submersible Ultraviolet Nitrate Analyzer (SUNA)		Date: 03/22/2022
NEON Doc. #: NEON.DOC.002716	Author: R. Willingham, M. Cavileer, J. Csavina, D. Monahan, B. Hensley	Revision: D

2 RELATED DOCUMENTS AND ACRONYMS

2.1 Applicable Documents

The following applicable documents (AD) contain mandatory requirements and/or supplementary information that are directly applicable to the topic and/or procedures herein. Visit the [NEON Document Warehouse](#) for electronic copies of these documents.

AD [01]	NEON.DOC.004300	EHSS Policy and Program Manual
AD [02]	NEON.DOC.004316	Operations Field Safety and Security Plan
AD [03]	NEON.DOC.050005	Field Operations Job Instruction Training Plan
AD [04]	NEON.DOC.001570	NEON Sensor Command, Control and Configuration (C3) Document: SUNA Nitrate Analyzer, Wadeable Streams
AD [05]	NEON.DOC.003808	NEON Sensor Command, Control and Configuration (C3) Document: Buoy Meteorological Station and Submerged Sensor Assembly
AD [06]	NEON.DOC.001972	AIS Comm Interconnect Mapping
AD [07]	NEON.DOC.004613	NEON Preventive Maintenance Procedure: AIS Buoy
AD [08]	NEON.DOC.003880	NEON Preventive Maintenance Procedure: AIS Stream Infrastructure
AD [09]	NEON.DOC.004713	AIS Stream Nutrient Analyzer Formal Verification Procedures
AD [10]	NEON.DOC.004886	NEON Preventive Maintenance Procedure: Aquatic Portal & AIS Device Posts
AD [11]	NEON.DOC.005048	NEON INSTALLATION PROCEDURE: HB066000XX- SUBSYSTEM, SENSOR INFRASTRUCTURE, STREAM, [SAND, BEDROCK, COBBLE]
AD [12]	NEON.DOC.005227	NEON Standard Operating Procedure: SUNA V2 Nitrate Sensor Data Management Procedure

2.2 Reference Documents

Reference documents (RD) contain information complementing, explaining, detailing, or otherwise supporting the information included in the current document.

RD [01]	NEON.DOC.000008	NEON Acronym List
RD [02]	NEON.DOC.000243	NEON Glossary of Terms
RD [03]	NEON.DOC.000769	Electrostatic Discharge Prevention Procedure
RD [04]	NEON.DOC.001570	NEON Sensor Command, Control and Configuration (C3) Document: AIS Nitrate Analyzer
RD [05]	NEON.DOC.004257	NEON Standard Operating Procedure (SOP): Decontamination of Sensors, Field Equipment and Field Vehicles
RD [06]	NEON.DOC.004638	AIS Verification Checklist
RD [07]	NEON.DOC.004608	AIS Buoy Verification Procedures
RD [08]	NEON.DOC.005038	NEON Standard Operating Procedure (SOP): Sensor Refresh
RD [09]	NEON.DOC.004472	PDS Array Device Post and Field Device Post Formal Verification Procedures
RD [10]	NEON.DOC.004651	Domain 18 (D18) AIS Oksrukuyik Creek (OKSR) Alternate Power Site Standard Operating Procedure (SOP)



Title: NEON Preventive Maintenance Procedure: Submersible Ultraviolet Nitrate Analyzer (SUNA)		Date: 03/22/2022
NEON Doc. #: NEON.DOC.002716	Author: R. Willingham, M. Cavileer, J. Csavina, D. Monahan, B. Hensley	Revision: D

2.3 External References

The external references (ER) listed below may contain supplementary information relevant to maintaining specific commercial products for the SUNA sensor and subsystem.

ER [01]	SUNA Manual, Rev. F https://www.seabird.com/asset-get.download.jsa?id=54627862534
ER [02]	Sea-bird Scientific, UCI User Manual, 02/2017, Edition 11 (UCI170209). http://www.seabird.com/sites/default/files/documents/UCI-1.2-User-Manual.pdf
ER [03]	UCI Software Download: N:\Common\CVL\Field_Calibration\UCI

2.4 Acronyms

AIS	Aquatic Instrument Systems
CVAL	Calibration, Validation and Audit Laboratory
DI	Deionized
EHSS	Environmental Health, Safety and Security
ESD	Electro-static Discharge
FOPS	Field Operations
GRAPE	Grouped Remote Analog Peripheral Equipment
GRSM	Great Smoky Mountain
HQ	Headquarters
MBARI	Monterey Bay Aquarium Research Institute
PAR	Photosynthetically Active Radiation
POE	Power Over Ethernet
PRT	Platinum Resistance Thermometer
PVC	Polyvinyl Chloride
S1	AIS Sensor Set 1 (upstream sensor set)
S2	AIS Sensor Set 2 (downstream sensor set)
SUNA	Submersible Ultraviolet Nitrate Analyzer
UV	Ultraviolet (light)



Title: NEON Preventive Maintenance Procedure: Submersible Ultraviolet Nitrate Analyzer (SUNA)		Date: 03/22/2022
NEON Doc. #: NEON.DOC.002716	Author: R. Willingham, M. Cavileer, J. Csavina, D. Monahan, B. Hensley	Revision: D

3 SAFETY AND TRAINING

Personnel working at a NEON site must be compliant with safe fieldwork practices in AD [01] and AD [02]. The Field Operations Manager and the Lead Field Technician have primary authority to stop work activities based on unsafe field conditions; however, all employees have the responsibility and right to stop work in unsafe conditions.

Technicians must complete safety training and procedure-specific training to ensure the safe implementation of this protocol per AD [03]. Refer to the site-specific EHSS plan via the NEON Safety document portal for electronic copies.

Preventive maintenance of AIS Infrastructure may require the use of a special equipment to access the sensor subsystem assemblies. Follow Domain site-specific [EHS plans via the Network Drive](#) and NEON safety training procedures when conducting maintenance activities. Conduct a Job safety Analysis (JSA) prior to accessing the sensor subsystems onsite. Reference the [Safety Office SharePoint portal](#) for JSA templates and additional hazard identification information.

Personal Protective Equipment (PPE) may be required in the decontamination procedures to maintain safe working conditions (e.g., use of equipment such as power washers, air compressors), and disinfectants. For this reason, personnel should be trained and familiar with the Safety Data Sheets (SDS) for the cleaning solutions, tools and equipment necessary for decontamination of the sensor sets herein.

Technicians must not enter the water without water safety training and a personal floatation device (PFD), and must display basic competency in boat operation, regardless of whether or not boat operation is a primary responsibility.



Title: NEON Preventive Maintenance Procedure: Submersible Ultraviolet Nitrate Analyzer (SUNA)		Date: 03/22/2022
NEON Doc. #: NEON.DOC.002716	Author: R. Willingham, M. Cavileer, J. Csavina, D. Monahan, B. Hensley	Revision: D

4 SENSOR OVERVIEW

4.1 Description

Nitrate (NO_3^-) is a naturally occurring nutrient that is vital for aquatic ecosystems, as it is a significant source of bioavailable nitrogen for aquatic plants. Increasing concentrations of nitrate from anthropogenic inputs (i.e., fertilizers or sewage) often act as a stressor rather than a beneficial nutrient and can stimulate a bloom in aquatic plant or algae populations, known as eutrophication. These blooms are often followed by depletion of dissolved oxygen as these algal cells decay, a condition known as hypoxia, which can be harmful to fish and other aquatic organisms. This makes nitrate a measurable indicator of potential anthropogenic stressors in aquatic ecosystems. To measure nitrate, the NEON program uses a Sea-Bird Scientific Submersible Ultraviolet Nitrate Analyzer (SUNA) V2 (version 2) with integrated antifouling/hydro-wiper with titanium housing ([0329950100](#) and 0329950005) sensor (**Figure 1**).



Figure 1. Sea-Bird Scientific SUNA V2 with Integrated Anti-Fouling Wiper.

This sensor is present at Aquatic Instrument System (AIS) stream (downstream only for sites with two sensor sets, S2), lake (buoy mounted at 0.5 m depth from water surface), and river sites (buoy mounted at 0.5 m depth from water surface). Each site contains the following subsystem components:

Wadeable Downstream Sites (AD [08])

- SUNA Power Cable, 75 Ft. (HB08820075) contains EEPROM
- Grape Merlot G4 12V, 2digi 6anlg (CB14023600) (data acquisition device) with sun shield Unistrut mount (CF00700000)
- Armored Power over Ethernet (PoE) cord, which connects from the SUNA Grape to the S2 Combination (Combo) Box onshore, which connects to the Aquatic Portal. A 75ft. cable is for high water installations where the Grape is nearby onshore (instead of the stream).

Lake and River Buoy Sites (AD [07])

- SUNA Power Cable, 15 Ft. (HB08820015) contains EEPROM
- Subsystem, DAS, Buoy, Nutrient Analyzer Telemetry (HB12140000): SUNA Radio Box, Cable and Antenna on the Buoy.
- Subsystem, DAS, Portal, Telemetry, Buoy (HB16100000): Includes the Buoy Portal Radio with serial cable from the Aquatic Portal radio to Oz Grape inside the Portal and the Antenna and Mast outside the Portal.



Title: NEON Preventive Maintenance Procedure: Submersible Ultraviolet Nitrate Analyzer (SUNA)		Date: 03/22/2022
NEON Doc. #: NEON.DOC.002716	Author: R. Willingham, M. Cavileer, J. Csavina, D. Monahan, B. Hensley	Revision: D

- PoE cord (from Grape to Aquatic Portal PoE Switch)

Sensor Accessories

- Y Validation/Calibration Cable with USB Connector, Amphenol Connector and Sensor Connector (HB09780000) (See **Figure 13**)

4.2 Handling Precautions

Aquatic Technicians must employ special care to avoid dropping solutions, hardware, or tools into the water while working to prevent contaminating an aquatic environment. In addition, per NEON.AIS.4.1735, all vehicles, trailers, boats, tools, protective outerwear, and any other items that encounter an aquatic or riparian environment, require decontamination prior to site access per RD [05]. When transporting a biofouled SUNA in its case, take care to keep the sensor isolated from the carrying case.

4.2.1 Sensor Handling Precautions

While removing, cleaning, or replacing the sensor, employ care when working with this sensor to prevent scratches on the optical windows or path material, which may alter light refraction, and therefore alter nitrate measurement collection. Damage to the optics may result in inaccurate nitrate measurements.

The SUNA connector end of the cable is especially sensitive to bending. Tight bends may damage the internal wires, shorting out the SUNA's power or Comms, or both. Never bend the cable, especially at the connector, tighter than a 6-inch radius. Leave slack in the sensor cable when dressing the cable(s) to prevent strain and/or sharp bends in the cable. Never lift the sensor by the cables. Damage to the sensor housing or cable assembly may result in electrical failure.

4.2.2 Subsystem Handling Precautions

Grapes and PoE devices contain electrostatic discharge sensitive parts (see RD [03]); therefore, all Grapes require ESD (antistatic) packaging and handling during inter- and intra-site transport, reception and storage. As a rule, when handling (installing, removing, and servicing) these components, Technicians must ground themselves. Do not hot swap sensor connections! When power is ON, disconnect the RJF/Eth-To Comm Box cable BEFORE disconnecting a sensor cable. Connect a sensor cable BEFORE connecting the RJF/Eth-To Comm Box cable.

4.3 Operation

The SUNA is a high-resolution spectrometer that utilizes ultraviolet (UV) range wavelengths (190-370 nm). The sensor consists of a stable deuterium lamp, a detector, an on-board controller and an internal data storage device. The SUNA internally converts signals to digital readings and applies algorithms



Title: NEON Preventive Maintenance Procedure: Submersible Ultraviolet Nitrate Analyzer (SUNA)		Date: 03/22/2022
NEON Doc. #: NEON.DOC.002716	Author: R. Willingham, M. Cavileer, J. Csavina, D. Monahan, B. Hensley	Revision: D

created by the Monterey Bay Aquarium Research Institute (MBARI) and Sea-Bird Scientific prior to output.

Water flows between two quartz windows that are 1-cm or 0.5 cm apart (the 0.5 cm window is designed for sites with optically dense water, SUGG is the only site in the NEON observatory with a 0.5 cm opening), continuously flushing the optical path. To collect a measurement, the SUNA applies an UV light source across the water sample in the optical path. Nitrate in the water absorbs light from the lamp in the 217-240nm range. The spectrometer measures how much light passed through the sample at each wavelength compared to a DI reference sample. For each measurement, the sensor records light frames (when the lamp is on) and dark frames (when the lamp is off) to account for any background light reaching the detector. The absorbance signal, due to nitrate in the water, is proportional to its concentration in the sample. It is critical to have a stable light source and a spectrometer capable of resolving the spectra for the nitrate in the water. Between measurements, the analyzer uses sleep mode to conserve power and extend the life of the deuterium lamp. Configuration of this sensor is in accordance with RD [04] to collect a burst of measurements at 15-minute intervals.

4.4 Theory of Absorbance Measurements

A spectrometer splits light into various wavelengths, and then measures the absorbance at each of these wavelengths (Figure 2). Absorbance is the amount of light absorbed by a sample, which is calculated using the ratio of incident light received by the sample divided by the light transmitted by the sample (Equation 1). The incident light put out by the SUNA lamp across all wavelengths (a spectrum) is characterized by sampling a DI “blank”, which is then stored as a file on the instrument.

$$A = \log_{10} \frac{\Phi_e^i}{\Phi_e^t}$$

Equation 1. Equation for Calculating Absorbance as the Log of the Ratio of Incident Light to Transmitted Light.

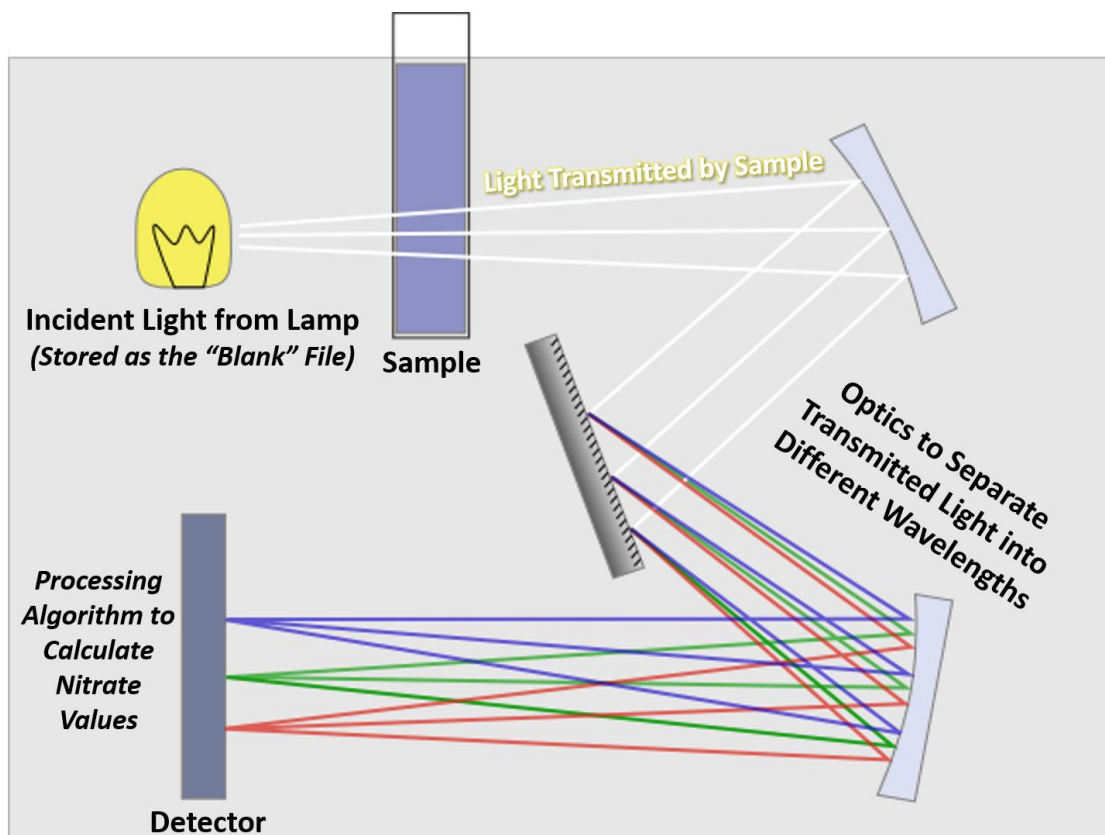

Figure 2. Overview of How a Spectrometer, such as the SUNA, Creates Absorbance Measurements.

The absorbance is then used to calculate nitrate concentration using the Beer-Lambert Law which states that concentration in units of mol/L equals absorbance divided by the pathlength (1 or 0.5 cm) and an extinction coefficient ϵ in units L/mol/cm (Equation 2).

$$C = \frac{A}{l \times \epsilon}$$

Equation 2. Equation Used to Calculate Concentration from Absorbance.

Since the output of the SUNA lamp decays over time, the “blank” file, which is used to characterize lamp output, requires periodic updating. In addition, collecting “blank” file measurements with anything other than pure DI water compromises the calculation of the absorbance values. **This is why it is critical to maintain a clean sensor when capturing a “blank” file. A clean sensor is a sensor where there is no biofouling, no scratches on the windows, no bubbles and uses pure, fresh DI water when collecting a “blank” file measurement.**

For SUNA data collection, any compound that also absorbs or scatters UV light affects the absorbance reading. For example, natural conditions, such as high dissolved organic matter (DOM) or turbidity alters the transmittance. The absorption range of DOM overlaps with that of nitrate, while turbidity scatters light, preventing it from reaching the SUNA’s detector. The SUNA’s algorithms that convert absorbance



Title: NEON Preventive Maintenance Procedure: Submersible Ultraviolet Nitrate Analyzer (SUNA)		Date: 03/22/2022
NEON Doc. #: NEON.DOC.002716	Author: R. Willingham, M. Cavileer, J. Csavina, D. Monahan, B. Hensley	Revision: D

to nitrate concentration are sophisticated and account for these in many circumstances. However, if transmittance (Φ^t/Φ^i) at a given wavelength falls below 5% (equaling an absorbance value greater than 1.3), the SUNA omits that wavelength from its calculation. If less than 10 wavelengths within the SUNA absorbance range (217-240 nm) remain, the SUNA is unable to make an accurate prediction of concentration and reports an error. Debris or biofilms on the SUNA windows can also absorb or scatter light, and the SUNA algorithm is unable to correct for this in the data; ***a clean debris-free sensor is important for good nitrate data!***

 **PRO TIP:** The SUNA V2 uses “-1” to indicate low transmittance. If you notice sequences of -1 concentration (μM **and** mg-N/L) in your SUNA data, report it by creating an incident ticket.



Title: NEON Preventive Maintenance Procedure: Submersible Ultraviolet Nitrate Analyzer (SUNA)		Date: 03/22/2022
NEON Doc. #: NEON.DOC.002716	Author: R. Willingham, M. Cavileer, J. Csavina, D. Monahan, B. Hensley	Revision: D

5 INSPECTION AND PREVENTIVE MAINTENANCE

5.1 Equipment

Table 1. Preventative Maintenance Equipment.

Part No.	Description	Quantity
Tools		
HB09780000	USB-Power-SUNA Cable (Y-Cable for SUNA Field Validations/Calibrations)	1
NEON	Tablet and/or Notebook and pen/pencil	1
NEON, IT	PC Laptop with latest UCI software installed	1
GENERIC	1 Liter Nalgene wash bottle	2
GENERIC	1 Liter Glass or Teflon DI water bottle	1-2
GENERIC	5 Gallon Bucket or Dairy Crate (for water temperature equilibration)	1
GENERIC	5/16 th Allen Wrench	1
GENERIC	Flush cuts (for zip ties to remove sensor cables)	1
GENERIC	Scrub brush/dry brush (to clean off stream/lake/river infrastructure)	1
GENERIC	Waders	1
MX102344	[Optional] STANLEY Retractable Utility Knife, 3 Blades (to puncture Parafilm without compromising the film seal on the SUNA)	1
GENERIC	Plastic Pipette	1
GENERIC	Squirt bottle	1
Consumable items		
COMIN18JU007177	Dow Corning® 4 Electrical Insulating Compound	5.3 oz.
MX100642	Kimwipes/lint-free tissues (e.g., Opto-wipes) or microfiber cloths	4
MX100691	Wrapping Film, 4in. Wide Roll (Parafilm or Equivalent)	200 cm
GENERIC	Fresh MilliQ Deionized (DI) water per Section 5.3.4	1 L
GENERIC	> 90% isopropyl or ethyl alcohol (in a wash bottle)	100 mL
GENERIC	Zip ties	A/R
GENERIC	Powder-free nitrile gloves	A/R
GENERIC	Vinegar (Acetic Acid)	A/R
Resources		
	SUNA V2 Manual https://www.seabird.com/asset-get.download.jsa?id=54627862534	1
	UCI Software Manual https://www.seabird.com/asset-get.download.jsa?id=54712835755	1
	Sea-bird Scientific UCI (for SUNA Validation and Calibration): N:\Common\CVL\Field_Calibration\UCI DO NOT REMOVE THE CABLE FROM THE SUNA WITHOUT DISCONNECTING FROM THE UCI SOFTWARE FIRST!	1
	FTDI Driver http://www.ftdichip.com/FTDrivers.htm (use with loaner laptops)	A/R
	XCTU (SUNA Radio Config): https://www.digi.com/products/xbee-rf-solutions/xctu-software/xctu	A/R
	PuTTY: https://www.putty.org/ (Use to access data streams in real time)	1
	LC State of Health (SOH) App: http://soh.ci.neoninternal.org/	1
	IS Monitoring Suite: N:\Common\CVL\Field_Calibration\Required Directory\Test_Data\Current Executables\IS Control and Monitoring Suite	1
	SSL for AIS Sensors and Subsystem Components: https://neoninc.sharepoint.com/sites/fieldops/database/FOPs%20Database/SitePages/Sensors.aspx?Department=AIS	1
	Document Warehouse: https://neoninc.sharepoint.com/sites/warehouse/Documents/Forms/AllItems.aspx	1



Title: NEON Preventive Maintenance Procedure: Submersible Ultraviolet Nitrate Analyzer (SUNA)		Date: 03/22/2022
NEON Doc. #: NEON.DOC.002716	Author: R. Willingham, M. Cavileer, J. Csavina, D. Monahan, B. Hensley	Revision: D

5.2 Subsystem Location and Access

5.2.1 Wadeable Stream Sites

At wadeable stream sites, the SUNA sensors are part of the downstream sensor set (S2) or single station sensor sets. The SUNA is co-located with a Multisonde, Photosynthetically Active Radiation (PAR) PQS1 sensor, Platinum Resistance Thermometer (PRT), and Level TROLL (**Figure 3**). To ensure SUNA samples from an area are representative of an entire water column, the SUNA must be set at 50% (+/- 20%) between 40-80% of the water depth as measured from the surface. In other words, if the site is 1m deep, the SUNA should be positioned at a depth between 0.4-0.8m measured from the surface (or conversely 0.2-0.6m measured from the streambed). The site should also be located in either the thalweg (deepest part of the active channel) or another well-mixed location. The SUNA and the Multisonde must be set at the same level; the SUNA is within 40 cm horizontally of the Multisonde water quality measurements and within 3 cm of the same depth to associate the data of each sensor set. The sensor subsystems (power and communication systems) are with the sensors on an anchor or nearby onshore.

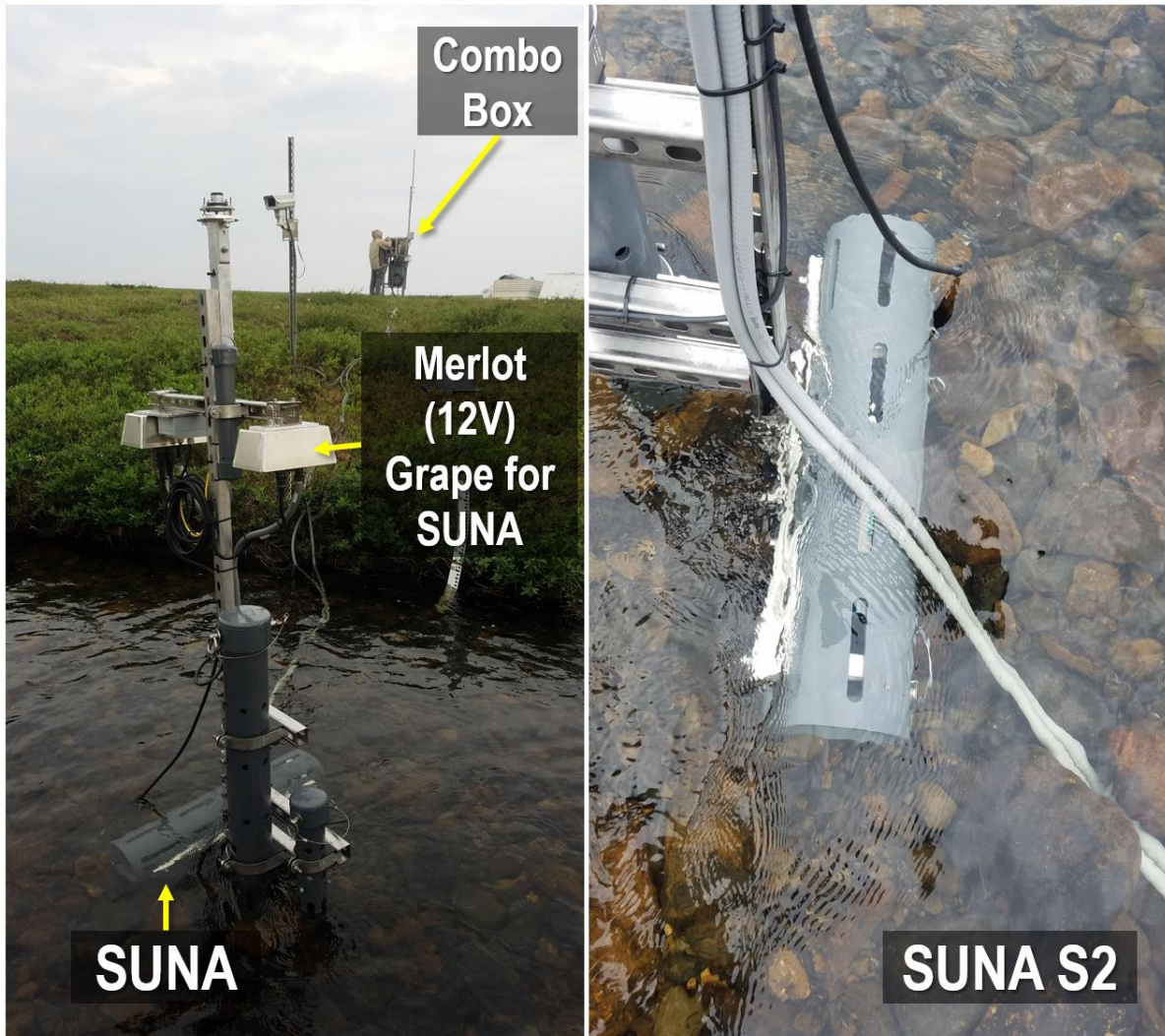

Figure 3. S2 Downstream Location: SUNA on an Anchor with Subsystem Components at a Low Water Site.

At high-water sites, the sensor Grape mounts to an arbor on or above the bank onshore as a stand-alone installation or on a device post with a Power and/or Comm/Combo box (**Figure 4**). The Grape supplies power to the SUNA and transmits its data to the Location Controller (LC) in the Aquatic Portal. Reference AD [08] and AD [10] for more information on AIS stream mechanical and electrical infrastructure.



Title: NEON Preventive Maintenance Procedure: Submersible Ultraviolet Nitrate Analyzer (SUNA)		Date: 03/22/2022
NEON Doc. #: NEON.DOC.002716	Author: R. Willingham, M. Cavileer, J. Csavina, D. Monahan, B. Hensley	Revision: D



Figure 4. Stream Stand-Alone Arbors (left, middle) and Device Post Arbor (far right) .

5.2.2 Lake and River Sites

At river and lake sites, the SUNA mounts from the AIS buoy in an enclosure 0.5 meters below the water surface. The AIS Buoy is a floating platform that includes an integrated meteorological (MET) station, an in-situ aquatic sensor set that includes; a fixed underwater measurement set, and a profiling underwater measurement set (**Figure 5**). At lake sites, the buoy anchors in the deepest location of the lake. At river sites, the buoy anchors as close to the rivers thalweg as possible, constrained by either navigation pathways, or the strength of the river’s current.



Figure 5. AIS Buoy for Lake and River Sites.

The SUNA is on the Dual PAR SUNA Mount inside a cage with two underwater PAR sensors on each end at every site, except for one in Domain 03 at Flint River (FLNT). This suspends the SUNA underwater when the buoy is in operation (**Figure 6**).



Title: NEON Preventive Maintenance Procedure: Submersible Ultraviolet Nitrate Analyzer (SUNA)		Date: 03/22/2022
NEON Doc. #: NEON.DOC.002716	Author: R. Willingham, M. Cavileer, J. Csavina, D. Monahan, B. Hensley	Revision: D

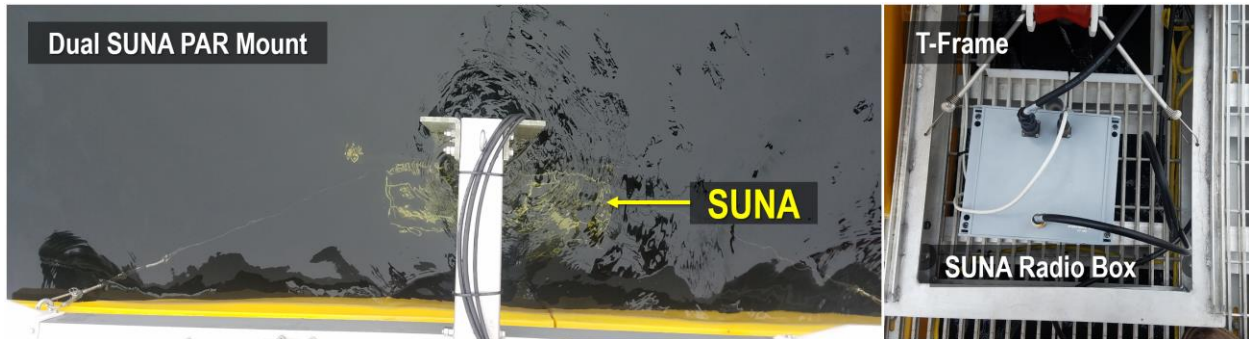

Figure 6. Dual SUNA PAR Mount and Radio Box on AIS Buoy

The SUNA at FLNT mounts next to a Multisonde sensor, in a fixed PVC tube under the buoy deck grate (Figure 7). Reference AD [07] for more information on AIS Buoy sensor removal/replacement.

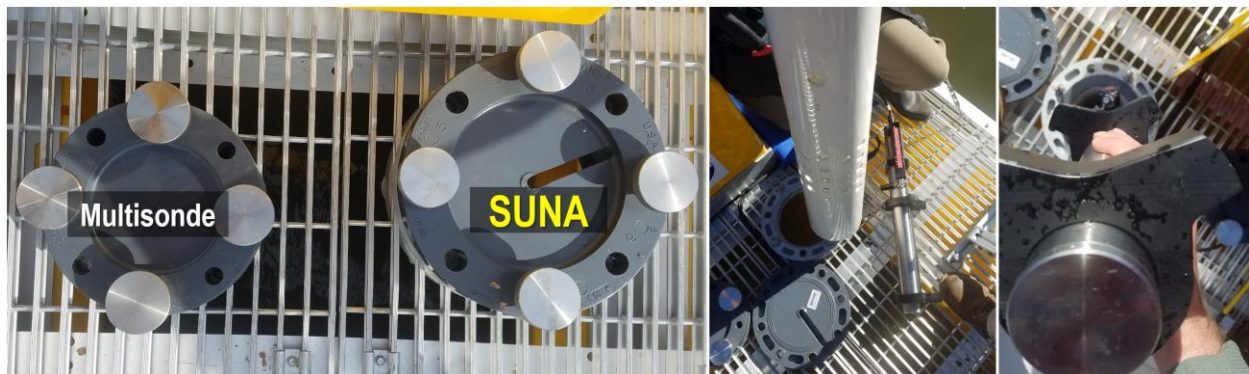

Figure 7. SUNA Location on AIS Buoy for D03, FLNT.

The data from the SUNA transmits directly via radio, which exists specifically for the SUNA on the buoy due to CR1000 usage limits. The CR1000 is a Campbell Scientific data logger; the buoy does not use Grape data loggers for the sensors onboard. The SUNA radio (Figure 6) transmits to a radio in the Aquatic Portal, which connects to an Oz Grape to transmit SUNA data to the LC (Figure 8).

Note: The Oz Grape does not require annual calibration and validation (do not remove this Grape for Sensor Refresh).

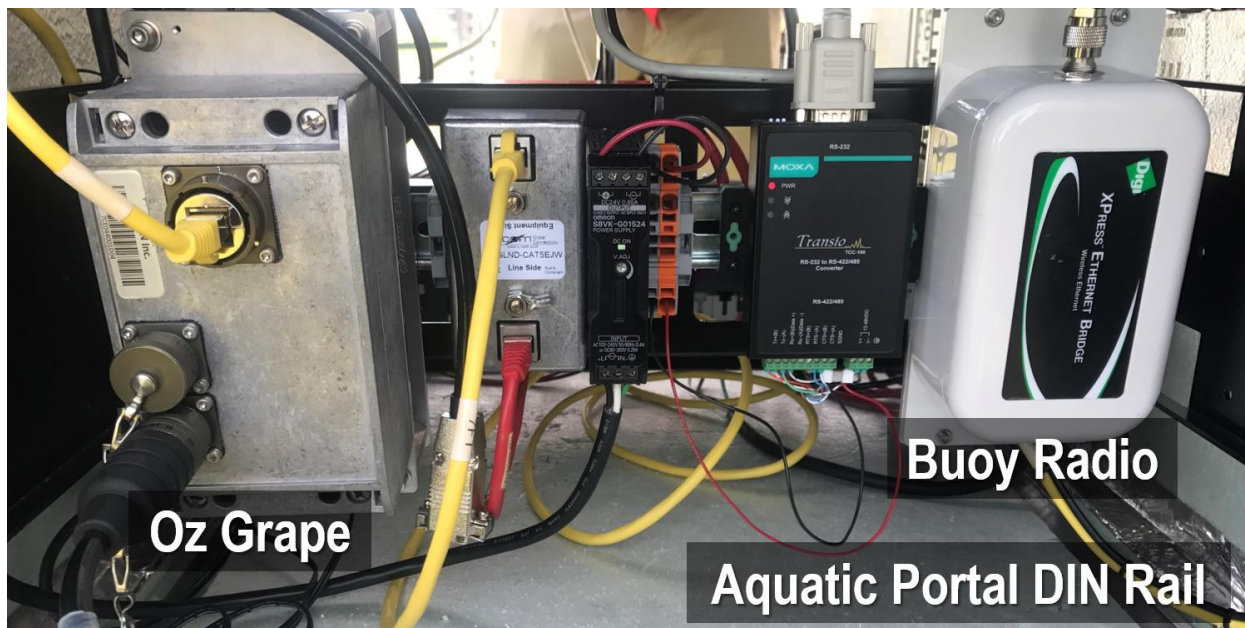

Figure 8. Aquatic Portal Precip DIN Rail: AIS Buoy Portal Radio/Oz Grape Subsystem.

Onboard solar panels and batteries power the buoy sensor sets. The SUNA radio box connects directly to the battery box for power. Reference AD [07] and AD [10] for more information on AIS Buoy mechanical and electrical infrastructure.

5.3 Maintenance Procedure

Table 2 is an interval schedule of each component requiring preventive maintenance.

Table 2. SUNA Preventative Maintenance Tasks Interval Schedule.

Maintenance	Bi-Weekly	Monthly	Quarterly	Bi-Annual	Annual	As Needed	Maintenance Type
SUNA							
Remote Monitoring	<i>Verify Data is Streaming Daily!</i>						P
Visual Inspection	X						P
Remove Debris from/Clean PVC Enclosure/Cage	X					X	P
Clean Sensor	X						P
Field Validations (Drift Test)	X						P
Domain Validations (Reference Check)			X			X	P
Reference Spectrum Calibration		X				X	P
Lamp Inspection	X						P



Title: NEON Preventive Maintenance Procedure: Submersible Ultraviolet Nitrate Analyzer (SUNA)		Date: 03/22/2022
NEON Doc. #: NEON.DOC.002716	Author: R. Willingham, M. Cavileer, J. Csavina, D. Monahan, B. Hensley	Revision: D

Maintenance	Bi-Weekly	Monthly	Quarterly	Bi-Annual	Annual	As Needed	Maintenance Type
Lamp Replacement (Sensor Refresh)						X	P/R
Wiper Brush Check	X						P
Replace Wiper Brush						X	R
Download Data Log			X				R
Seasonal Maintenance			X		X	X	P/R
Electrical & Communication Infrastructure (DAS and PDS)							
Visual Inspection	X						P
Replace Cable Ties						X	R
Clean Biofouling from Cables/Wires	X					X	P/R
MISCELLANEOUS EQUIPMENT							
Physical Infrastructure							
Visual Inspection	X						P
<i>P = Preventive, R = Repair, X = Indicates preventive maintenance task time interval may increase due to environmental (seasonal/weather) or unforeseen/unanticipated site factors.</i>							

5.3.1 Preventative Maintenance Procedure Sequence Overview

5.3.1.1 Daily

Remotely monitor SUNA data streams to verify the sensor is online, operational and data is reaching HQ. Conduct this remote monitoring through the sensor health, DQ Blizzard, and Site Sensor Mismatch Report.

5.3.1.2 Bi-weekly

The following is a summary list of bi-weekly maintenance procedures herein.

- Visual Inspections of Sensor, Subsystems, and Infrastructure (Section 5.3.3)
 - Reference AD [08] for preventive maintenance procedures for stream infrastructure.
 - Reference AD [07] for preventive maintenance procedures for the AIS Buoy infrastructure.
 - Reference AD [10] for general AIS site electrical infrastructure.
- Field Validation Procedures (Section 5.4)
 - Prepare and equilibrate DI water for sensor maintenance.
 - Collect a pre-clean SUNA nitrate reading.
 - Clean sensor body and optical window.
 - Collect a post-clean SUNA nitrate reading.
- Verification of Sensor Configuration/Settings (Section 5.4.6 to Section 5.4.9)
 - Check the SUNA lamp life hours to determine if the SUNA requires Sensor Refresh.
 - Synchronize the SUNA clock to prevent drift.



Title: NEON Preventive Maintenance Procedure: Submersible Ultraviolet Nitrate Analyzer (SUNA)		Date: 03/22/2022
NEON Doc. #: NEON.DOC.002716	Author: R. Willingham, M. Cavileer, J. Csavina, D. Monahan, B. Hensley	Revision: D

- Verify configuration settings are in accordance with RD [4].

 **CRITICAL NOTE:** *Wait at least 5 minutes after physically disconnecting the SUNA from the Grape after conducting maintenance using the UCI software and before reconnecting the SUNA to the Grape for deployment at stream sites. This resets the Grape communication protocols to reinitialize with the SUNA together. Failure to reset the Grape’s communication protocol prevents the SUNA data from streaming to the LC. See Section 5.5, Step 5 on page 46 to verify the SUNA data stream is present before leaving the site. This does not apply to SUNA instrument and subsystem on the AIS Buoy.*

5.3.1.3 Monthly

Perform field calibration procedure to update the Reference Spectrum on a monthly basis. See Section 5.6 for more information.

5.3.1.4 Annually

Conduct Sensor Refresh on the SUNA annually. See Section 6 and RD[08] for more information.

5.3.1.5 Seasonal Variances/As-Needed Basis

Adjust the SUNA mount at wadeable stream locations to ensure the sensor continues to meet the science requirement for its in situ location onsite (40-80% of water depth as measured from the surface) If the SUNA is too high it will come out of the water during decreasing flow. If the SUNA is too low, sediment stirred up from the bottom may potentially interfere with sensor operation. See Section 5.7 Seasonal Maintenance (Stream Sites) on page 50 for more information.

5.3.2 Remote Monitoring

Verify the SUNA is streaming data to HQ daily. Reference **Table 1** in the Resources section for links to the following remote monitoring software applications: the DQ Blizzard, IS Monitoring and Control Suite, PuTTY, and the LC SOH. Additionally, use remote monitoring to check the quality of the data streams.

Field Science is responsible for monitoring the quality of data from all sensors within their Domain to determine if the instrument requires corrective maintenance. See Section 9 for instructions on connecting remotely to the SUNA and basic troubleshooting from a remote location to identify preventive or corrective actions onsite.

For the SUNA, remote monitoring is the first step in quality control of the data. Currently, AQU SCI recommends using the DQ Blizzard application to monitor quality, and observe SUNA data to understand data ranges expected for your sites. The aim is to monitor for unexpected changes to the data to report it ASAP. AQU SCI also recommends monitoring SUNA cumulative lamp time, relative humidity, and sensor temperature.

 **Note:** *Data streaming from sensors under the wrong CFGLOC in Maximo affects data product data quality and requires HQ to flag the data. Grape data loggers always remain at the SITE level.*



Title: NEON Preventive Maintenance Procedure: Submersible Ultraviolet Nitrate Analyzer (SUNA)		Date: 03/22/2022
NEON Doc. #: NEON.DOC.002716	Author: R. Willingham, M. Cavileer, J. Csavina, D. Monahan, B. Hensley	Revision: D

5.3.3 Visual Inspections

The goal of all AIS instrumentation is to measure natural conditions. To that aim, NEON’s Preventive Maintenance procedures should cause little to no disturbance to the natural conditions at the site. In general, the implementation of preventive maintenance procedures should not require removal of live rooted vegetation. We do not want to remove any living vegetation surrounding the sensor and infrastructure. However, if living vegetation is growing directly on the infrastructure or entangled in such a way that it prevents the removal and maintenance of the SUNA, remove as little vegetation as possible to access the sensor and/or its subsystems. Do not remove vegetation that does not directly interfere with the maintenance or safety of the sensor and personnel servicing the sensor.

Reference AD [08] for visual inspection of stream infrastructure, AD [07] for visual inspection of the AIS Buoy infrastructure, AD [10] for general AIS site electrical infrastructure. These reference documents include the stream anchors, buoy sensor mounts, Aquatic Portal and device posts, and subsystem components and their supporting infrastructures.

Specific visual inspections for the sensor and its infrastructure include inspecting the following components in **Table 3** for visible damage (Figure 9), tampering, corrosion, degradation and significant bio fouling. Capture pictures of each component displaying damage/issues and report incidents in the NEON Program’s Issue Reporting and Management System.

Table 3. Components Requiring Visual Inspections.

STREAM SITES	LAKE/RIVER SITES
Sensor PVC Housing on Stream Anchor	Sensor Cage on Dual PAR SUNA Mount D03 FLNT: PVC Housing under Buoy deck grates
Sensor power cable to Merlot Grape	Sensor power cable to SUNA Radio Box
12V Merlot Grape connections and connectors	SUNA Radio Box connections and connectors
Armored Ethernet cable to Combo box	Power cable to battery box
Combo box connections and connectors	Aquatic Portal Precip DIN Rail (Radio & Oz Grape)

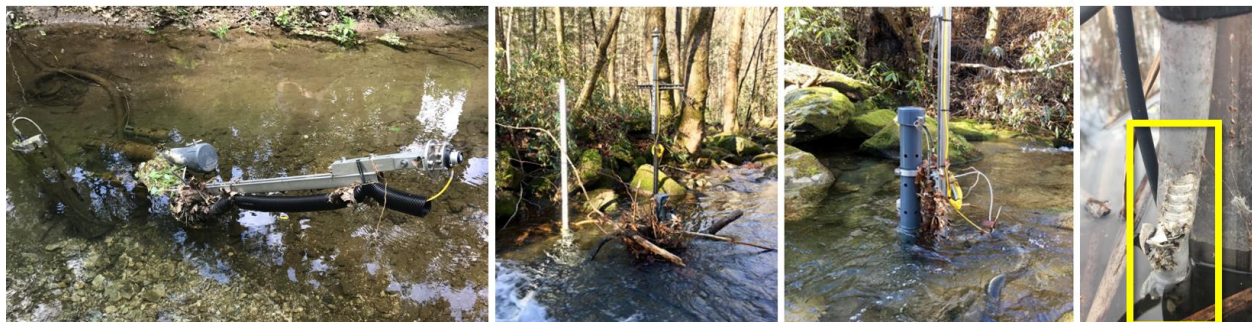



Figure 9. Examples of Damage to Report.



Title: NEON Preventive Maintenance Procedure: Submersible Ultraviolet Nitrate Analyzer (SUNA)		Date: 03/22/2022
NEON Doc. #: NEON.DOC.002716	Author: R. Willingham, M. Cavileer, J. Csavina, D. Monahan, B. Hensley	Revision: D

5.3.4 Bulkhead Connectors and Cable Maintenance

Connectors that have corrosion may cause irreparable damage to the sensor, a loss of data and increase the costs for service. Attach cleaned and lubricated dummy connectors to the sensor immediately after each deployment to prevent the bulkhead connector from damage with the following procedure.

 **Note:** Do not use cleaners that contain petroleum or ketones. **Do not use the cable to lift the sensor!** This can damage the cable, cable splices, and bulkhead connectors. Do not connect or disconnect connectors under water.

1. Examine, clean, and lubricate bulkhead connectors each time they are connected. Connectors that are not lubricated cause wear and tear on the rubber that seals the connector contacts.
2. Clean the connector contacts with isopropyl alcohol. Apply as a spray or with a nylon brush or lint-free swabs or wipes.
3. Flush the contacts with de-ionized or distilled water. Use a wash bottle with a nozzle to flush inside the sockets over a bucket and dispose of the water using local Domain wastewater procedures.
4. Shake the socket ends and wipe the pins of the connectors to remove water.
5. Examine the sockets and the rubber on the pins to make sure there are no problems. Use a flashlight and magnifying glass. Look for cracks, frayed scores, and delamination of the rubber on the pins and inside the sockets
6. Use a finger to place a small quantity, approximately 1.5 cm in diameter of Dow Corning® 4 Electrical Insulating on the socket end of the connector.

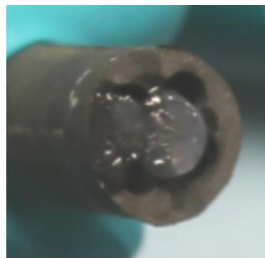

Lubricant on socket end of the connector



Lubricant pushed into the sockets of the connector

Figure 10. Lubricated Sockets for SUNA Bulkhead Connector.

7. Use a finger to push as much of the lubricant as possible into the sockets.
8. Connect the connectors. There should be a small quantity of lubricant squeezed out the seam of where the two connectors meet.
9. Wipe the excess lubricant from the sides of the connectors to complete this procedure.

5.4 Field Validation Procedures (Drift Test)

5.4.1 Sensor Deionized (DI) Water Requirements

This procedure is first because it requires additional preparation time in the Domain Support Facility and onsite with the SUNA sensor.



Title: NEON Preventive Maintenance Procedure: Submersible Ultraviolet Nitrate Analyzer (SUNA)		Date: 03/22/2022
NEON Doc. #: NEON.DOC.002716	Author: R. Willingham, M. Cavileer, J. Csavina, D. Monahan, B. Hensley	Revision: D

5.4.1.1 DI Water: Domain Lab Preparation

DI water must meet the following minimum requirements:

	Type I	Type II	Type III	Type IV
Electrical conductivity, max, $\mu\text{S}/\text{cm}$ at 298 K (25°C)	0.056	1.0	0.25	5.0
Electrical resistivity, min, Mcm at 298 K (25°C)	18	1.0	4.0	0.2
pH at 298 K (25°C)	4	4	4	5.0 to 8.0
Total organic carbon (TOC), max, $\mu\text{g}/\text{L}$	50	50	200	no limit
Sodium, max, $\mu\text{g}/\text{L}$	1	5	10	50
Chlorides, max, $\mu\text{g}/\text{L}$	1	5	10	50
Total silica, max, $\mu\text{g}/\text{L}$	3	3	500	no limit

Figure 11. DI Water Minimum Requirements: ATSM Type II¹

Poor quality, old, or improperly stored DI water can cause bad blank readings, resulting in incorrect measurement in the field. The intent here is to have sterile, nitrate and organic-free blank water for maintenance of optical sensors. Therefore, Field Science must conduct the following procedure before heading into the field to validate the SUNAs onsite.

1. Acquire fresh DI water from the domain support facility (DSF). The DI water is considered fresh if it was dispensed within 24 hours to meet the minimum standard specification of Type II water (**Figure 11**).
2. Use a calibrated handheld conductivity probe to validate that the DI water produced by the Domain’s DI water system meets the required conductivity @25C (or use specific conductance setting) (**Figure 11**) prior to going out into the field. Ensure the probe does not contaminate the water you use for any maintenance activities. If the DI water fails to meet the conductivity requirement, conduct the following steps:
 - a. Replace the DI water system cartridge and/or filter and test for conductivity again. If the filter replacement fixes the issue, then proceed with routine maintenance activities. If it does not, proceed to the next step.
 - b. Determine whether the DI water system cartridge and/or filter is defective and requires corrective action, or if this is a chronic problem caused by the quality of the Domain’s tap water. If you think it is the quality of the tap water, install a Reverse Osmosis filter system, in addition to the DI water system cartridge.

¹ The measurement of pH in Type I, II, and III reagent waters has been eliminated from this specification because these grades of water do not contain constituents in sufficient quantity to significantly alter the pH. Source: <https://www.astm.org/DATABASE.CART/HISTORICAL/D1193-99E1.htm>



Title: NEON Preventive Maintenance Procedure: Submersible Ultraviolet Nitrate Analyzer (SUNA)		Date: 03/22/2022
NEON Doc. #: NEON.DOC.002716	Author: R. Willingham, M. Cavileer, J. Csavina, D. Monahan, B. Hensley	Revision: D

- c. If you can fix the problem (DI water meets conductivity @25C) in ≤ 1 month, then wait until the problem is fixed before performing routine maintenance. If fixing the filter will take ≥ 1 month, borrow (e.g., from a local University) Type II water that meets the requirements or purchase HPLC (aka-type 1 water) water. If purchasing, only purchase Type I water in a glass bottle. Do not purchase Type II water; it will arrive in plastic bottles. Always store HPLC (type 1) in glass only. The goal is to let no more than 1 month of time pass beyond your scheduled maintenance bout.
- 3. Seal/store DI water in a combusted glass or clean Teflon container. DI water stored in plastic may have plastic molecules that have leached into the DI water that can absorb UV over the spectral range of the sensor, and will cause an incorrect DI blank reading.
- 4. Rinse bottles and caps with fresh DI water at least three (3) times before use.

5.4.1.2 DI Water: Field Equilibration Procedure

In order to accurately measure sensor drift from the pre- and post-cleaning reading of nitrate values, Field Science must equilibrate the DI water to ambient stream temperatures. Upon arrival to site or before beginning SUNA maintenance, choose one of the following options to equilibrate the DI water.

- A. Submerge a wash bottle full of DI water directly into the surrounding body of water. Be sure the wash bottle is secure and will remain in place, submerged without contamination for **10 minutes**. The temperature of the DI water must reach the same temperature as the body of water of the SUNA location onsite.
- B. Alternatively, use a five-gallon bucket or dairy crate to equilibrate DI water to site’s ambient water temperature (**Figure 12**) with the following procedure.

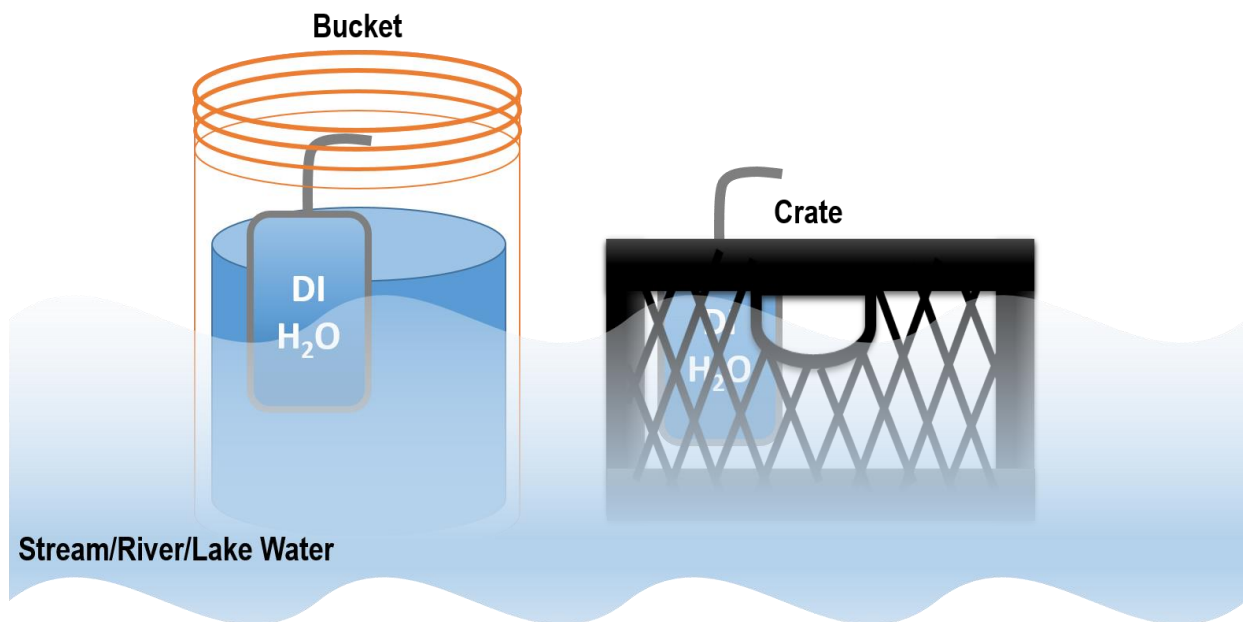

Figure 12. Alternate Setups for DI Water Temperature Equilibration .



Title: NEON Preventive Maintenance Procedure: Submersible Ultraviolet Nitrate Analyzer (SUNA)		Date: 03/22/2022
NEON Doc. #: NEON.DOC.002716	Author: R. Willingham, M. Cavileer, J. Csavina, D. Monahan, B. Hensley	Revision: D

1. Place approximately 18 inches of water from the site (e.g., stream, river or lake) into a 5-gallon bucket or skip this step and use a dairy crate.
2. Place the bucket or crate in the water. Ensure it is secure and will not float away. HQ recommends using a dairy crate since it allows the water flow through, instead of around, which results in achieving equilibrium quickly.
3. Place wash bottle full of DI water into water bath to equilibrate it to ambient water conditions.
4. Let stand at least **30 minutes** for the temperature of the DI water to reach the same temperature as the environment. After ~30 minutes, the assumption is the DI water is at ambient stream/lake/river temperature. If not, due to extreme heat temperatures and the bucket in direct sunlight, exchange the water in the bucket for fresh water and continue waiting until the DI water is at ambient water temperature. If the DI water is freezing during the validation or calibration process, or Technicians are unable to access the SUNA due to ice/unsafe working conditions, do not continue validations/calibrations.

5.4.2 Connect to SUNA

To calculate drift, technicians must record nitrate readings prior to cleaning and after cleaning. Connect to the SUNA using a field laptop that has the UCI Software via N:\Common\CVL\Field_Calibration\UCI. UCI is a software application for setup and configuration, operation, and in-field/Domain laboratory reference checks of the SUNA.

At the publication of this document, the current software version is UCI version 1.25. Follow the steps in **Table 4** to connect the SUNA to UCI software to initiate the field validation process. For lake and river sites, have AD [07] handy to understand additional information about the SUNA Buoy infrastructure.

Table 4. How-To: Connect SUNA for Field Validation Process.

STEP 1 | Acquire the necessary equipment to conduct field validations for the SUNAs onsite. This includes the HB09780000 SUNA Calibration Cable, which is a NEON custom Y-cable (Figure 13), to connect to GRAPE or Buoy SUNA Radio Box, and the laptop with UCI. This cable is for both Lake/River Buoy and Stream site SUNA calibrations/validations.

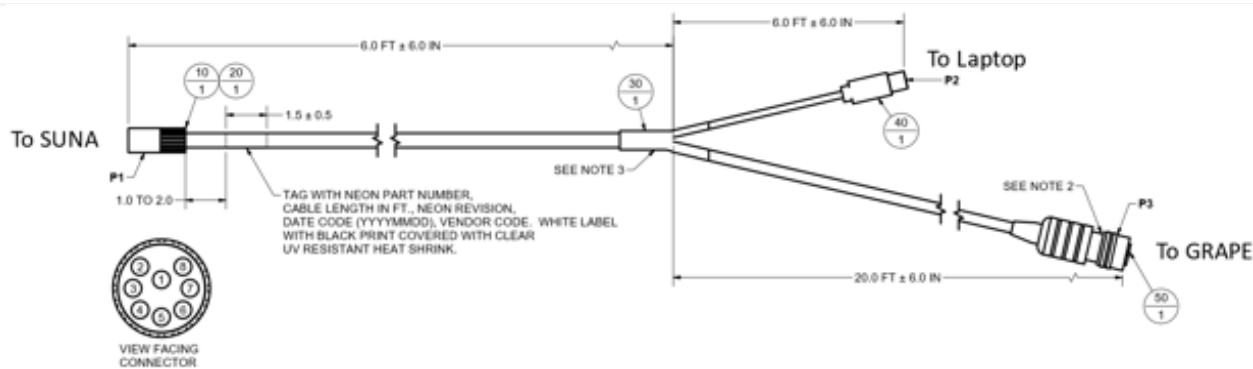

Figure 13. NEON Custom Y-Cable for Stream, Lake and River SUNA Field Validations/Calibrations (HB09780000)

STEP 2 | Disconnect the SUNA power source to safely de-energize the instrument and subsystem to prevent hot swapping Grape connections.



Figure 14. Disconnect the SUNA 12V Merlot Grape

STEP 2.1 | Stream sites: Disconnect the SUNA 12V Merlot Grape from power by disconnecting the Ethernet cable (RJF) that connects to the Grape (Figure 14). Then disconnect the SUNA power cable from the 12-10 connector on the Grape.

Always disconnect the RJF cable from the GRAPE prior to disconnecting (or connecting) any sensor instruments. Reference AD [06] for the AIS Comm Interconnect Mapping for the SUNA Grape and AD [01] and [07] for procedures on isolating the energy source and electrostatic discharge.

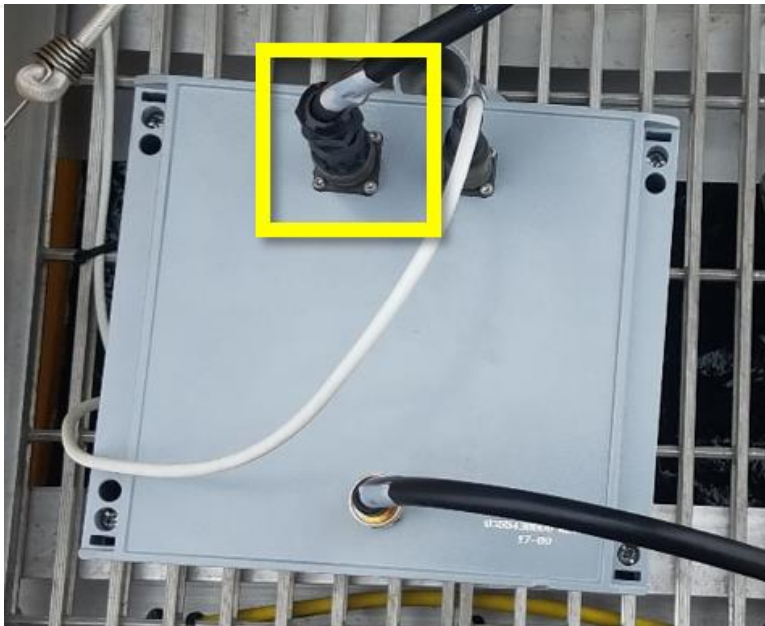

Figure 15. SUNA Radio Box on AIS Buoy: Power Connector (12-10)

STEP 2.2 | Buoy sites: The SUNA is powered by the SUNA radio box located under the yellow buoy housing, on the profiler winch side of the buoy t-frame (Figure 15).

Reference AD [06] for the SUNA Radio Box interconnect map.



Title: NEON Preventive Maintenance Procedure: Submersible Ultraviolet Nitrate Analyzer (SUNA)		Date: 03/22/2022
NEON Doc. #: NEON.DOC.002716	Author: R. Willingham, M. Cavileer, J. Csavina, D. Monahan, B. Hensley	Revision: D

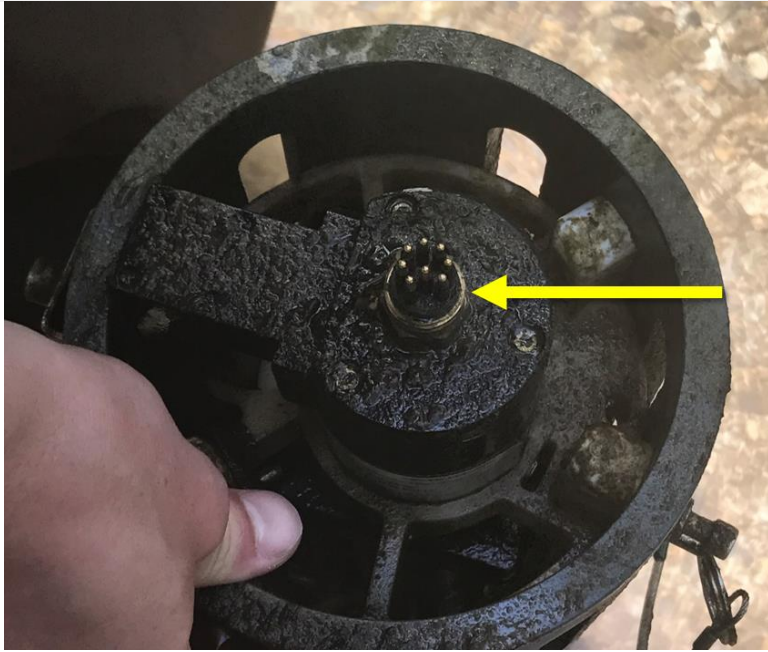

Figure 16. SUNA Bulkhead Connector

STEP 3 | Disconnect the power cable from the SUNA bulkhead connector. Figure 16 is the bulkhead connector on the SUNA where you would connect the power cable.

STEP 4 | Remove or make the sensor accessible to connect it to the SUNA calibration Y-cable for validations.



Figure 17. SUNA Mount and Enclosure in Stream Locations

STEP 4.1 | Stream sites: Remove the SUNA from the enclosure (Figure 17) following instructions in Section 6.2 for stream sites.



Figure 18. SUNA in Cage on Dual PAR SUNA Mount on the Buoy

STEP 4.2 | Buoy sites: Reference AD [07] for instructions on the infrastructure for the SUNA on the AIS Buoy.

Figure 18 shows the SUNA in the cage that is on the end of the dual PAR SUNA mount.



Figure 19. Connect the SUNA to the Y Cable

STEP 5 | Connect the SUNA calibration Y-cable to the SUNA bulkhead connector (Figure 19).

STEP 6 | Attach the power end of the SUNA calibration Y-cable to the 12-10 Connector on the Merlot Grape, SUNA radio box (Figure 20) or other power source. For the Grape, reattach the PoE power cable to the RJF Ethernet port to the Grape to supply power to the Grape. Always reconnect the Grape PoE Cable last. The order of the connections for the SUNA calibration Y-cable do not matter when the Grape is disconnected from the PoE Switch.

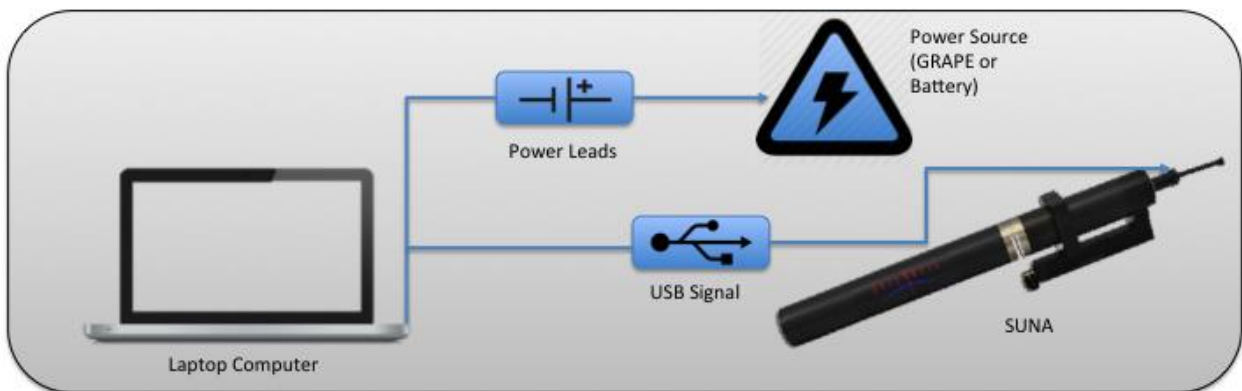

Figure 20. Functional Diagram of Y-Cable Connections for Validation Process



Title: NEON Preventive Maintenance Procedure: Submersible Ultraviolet Nitrate Analyzer (SUNA)		Date: 03/22/2022
NEON Doc. #: NEON.DOC.002716	Author: R. Willingham, M. Cavileer, J. Csavina, D. Monahan, B. Hensley	Revision: D



Figure 21. Attach Y-Cable to the Merlot Grape at Stream Sites

STEP 6.1 | Stream sites: Attach the Y cable to the 12V Merlot Grape in the same 12-10 connector as the sensor power cable (Figure 21).

Reference AD [06] for the AIS Comm Interconnect Mapping for the SUNA Grape. **Changes to AD [06] supersedes information herein.**

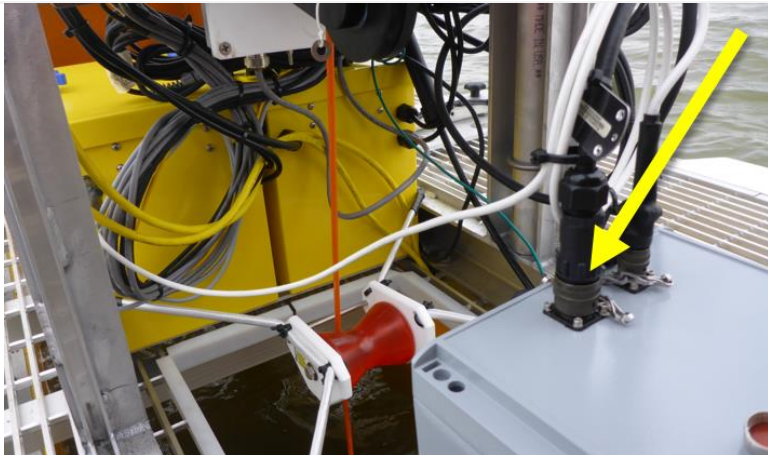

Figure 22. Attach Y-Cable to SUNA Radio Box at Buoy Sites

STEP 6.2 | Buoy sites: Attach the Y cable to the SUNA Radio Box 12-10 connector (Figure 22).

Reference AD [06] for the SUNA Radio Box interconnect map. There are no issues directly unplugging/plugging into the power connection (this is not like handling a Grape).



Figure 23. Attach USB Connector to Laptop

STEP 7 | Attach the USB end of the cable assembly to the field laptop computer (Figure 23).

Disable Bluetooth on your laptop. Bluetooth interferes with the laptops COM ports and may make the communication protocol with the SUNA unstable.

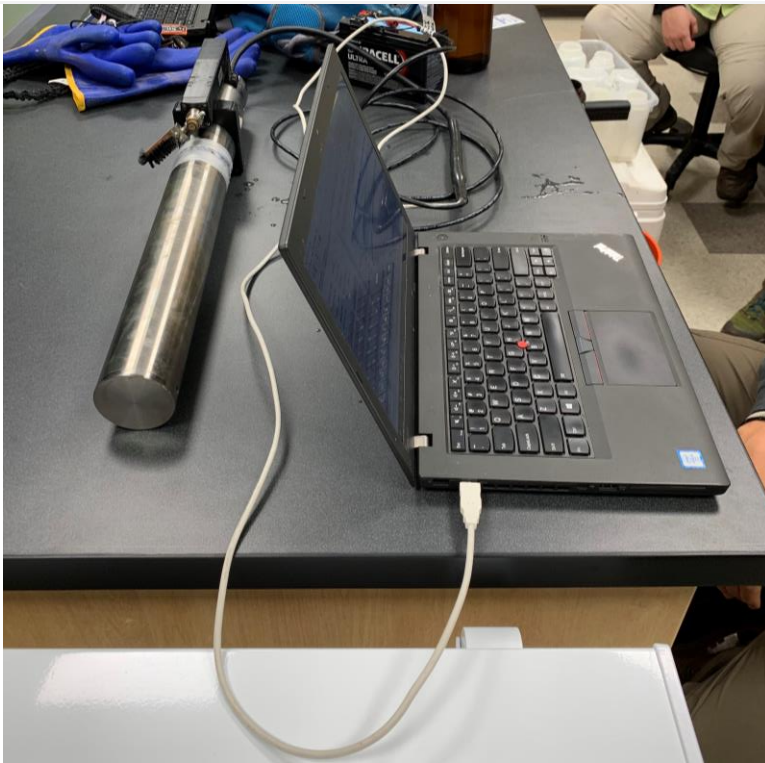

Figure 24. Example of Complete Setup for SUNA Validations

Figure 24 is an example of Steps 5-7 when complete. Here the power source is a lead acid battery.

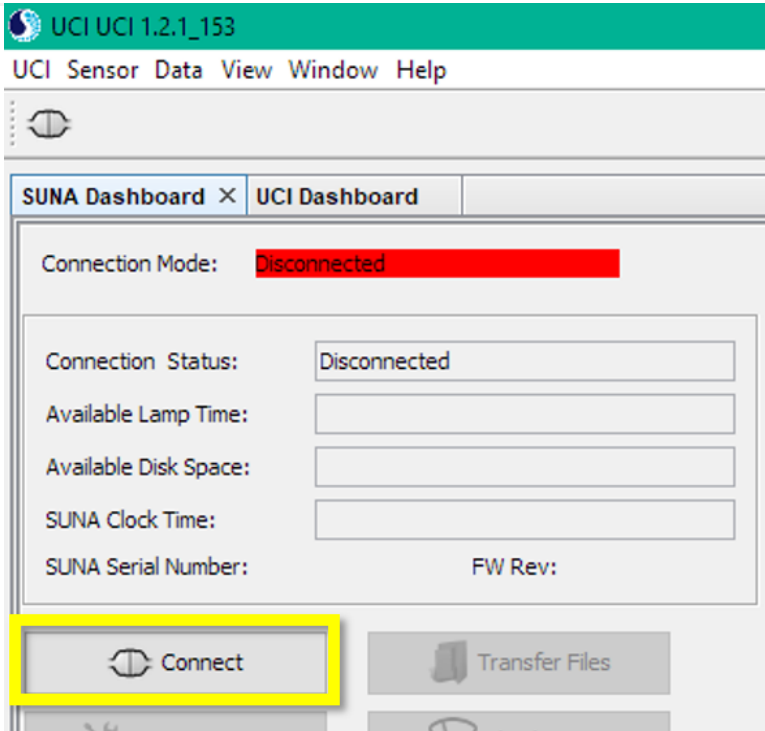

Figure 25. Select Connect

STEP 8 | Launch UCI 2.0.1 (formerly SUNACom) on a laptop. Select the "Connect" button under the SUNA Dashboard (Figure 25).

Some laptops may require FTDI drivers to run the software. FTDI drivers allows the software to connect to the SUNA through the laptops COM port. Without the FTDI drivers, the software is attempting to talk to the COM Port, but cannot connect.

STEP 9 | Select the baud rate from the dropdown options in the Connect pop-up window (Figure 26). 57600 is the baud rate for wadeable stream sites and 115200 is the baud rate for AIS buoy sites.



Title: NEON Preventive Maintenance Procedure: Submersible Ultraviolet Nitrate Analyzer (SUNA)		Date: 03/22/2022
NEON Doc. #: NEON.DOC.002716	Author: R. Willingham, M. Cavileer, J. Csavina, D. Monahan, B. Hensley	Revision: D

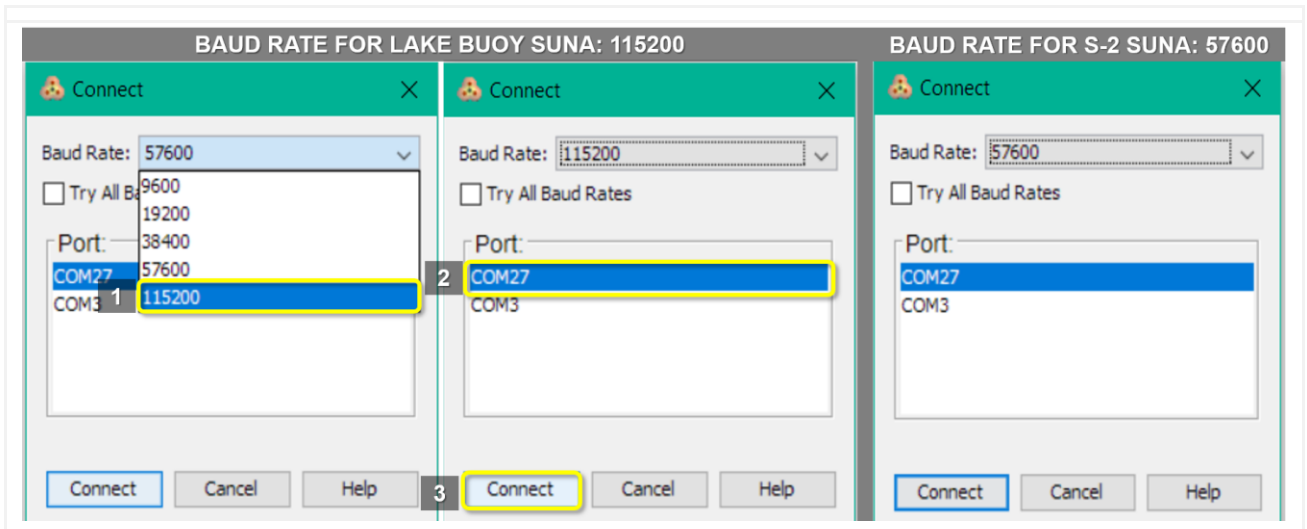

Figure 26. 57600 for Wadeable Stream Sites and 115200 for AIS Buoy Sites

STEP 10 | In the small window that pops up, select the appropriate “COM#” for **Port** (Figure 27).

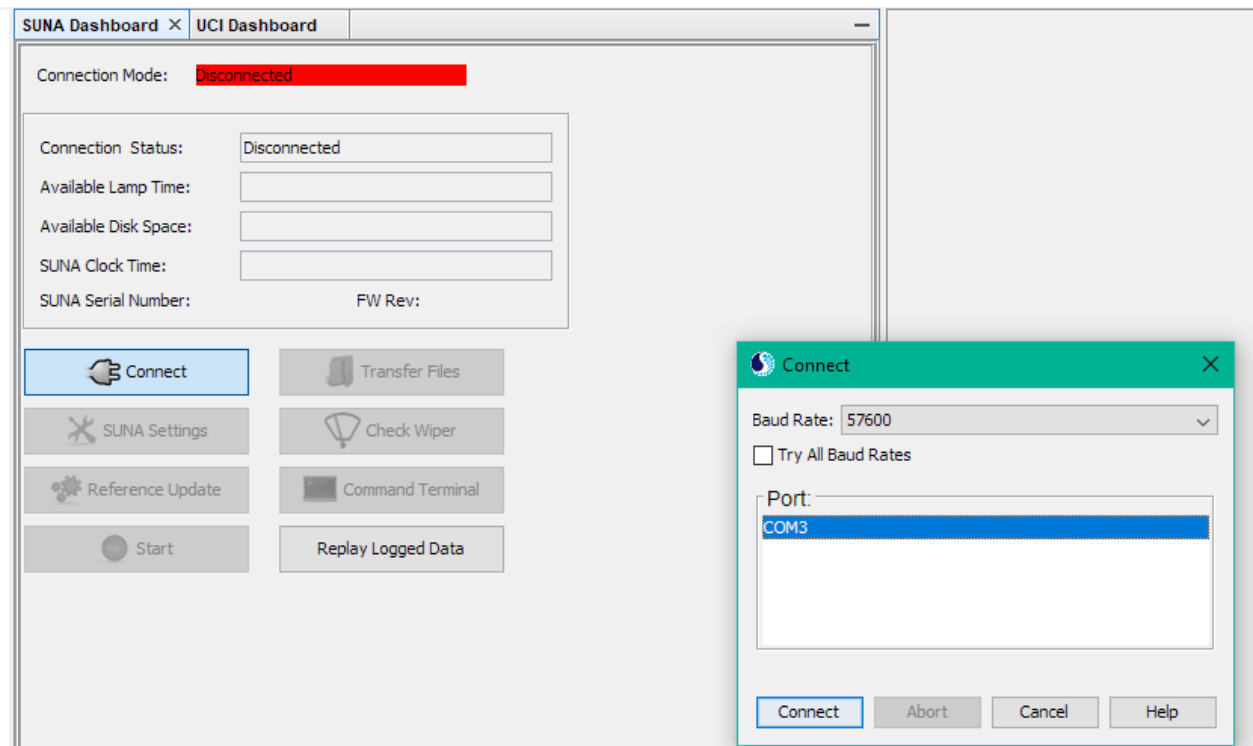



Figure 27. Connect Pop-up Window to Select Baud Rate and COM Port

 *Note: If unable to determine which port to use, verify laptop ports under **Device Manager** (they may differ across laptops). The SUNA is the other COM# port offered as an option. COM3 is the default COM port for Lenovo ThinkPad Laptops.*

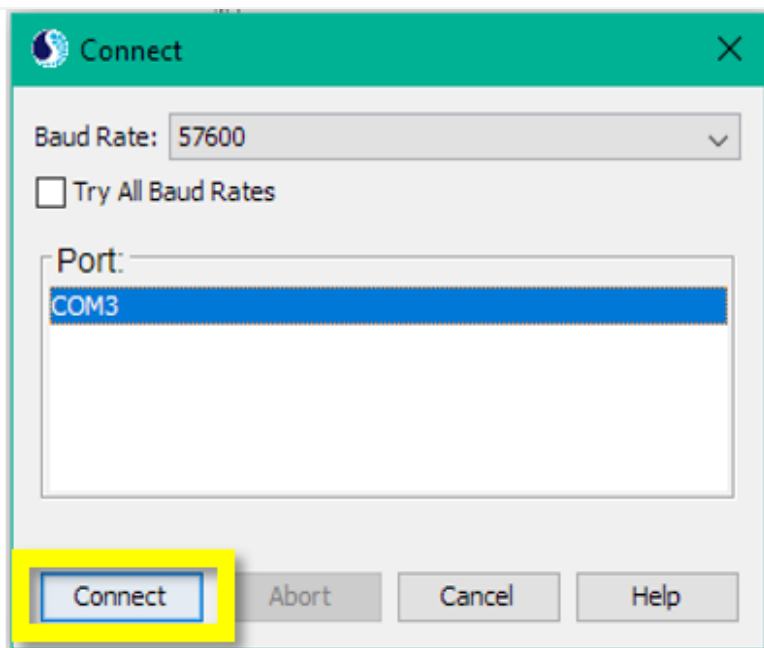

Figure 28. Select Connect

STEP 11 | Select **“Connect”** (Figure 28).

The **Connection Mode** under the **UCI Dashboard** tab in the upper left hand corner of the window changes to yellow and the **“Setup Console”** tab starts displaying characters.

Note: As a reminder from Step 9, this is the Baud Rate for Stream locations. The Baud Rate for Buoy locations is 115200.

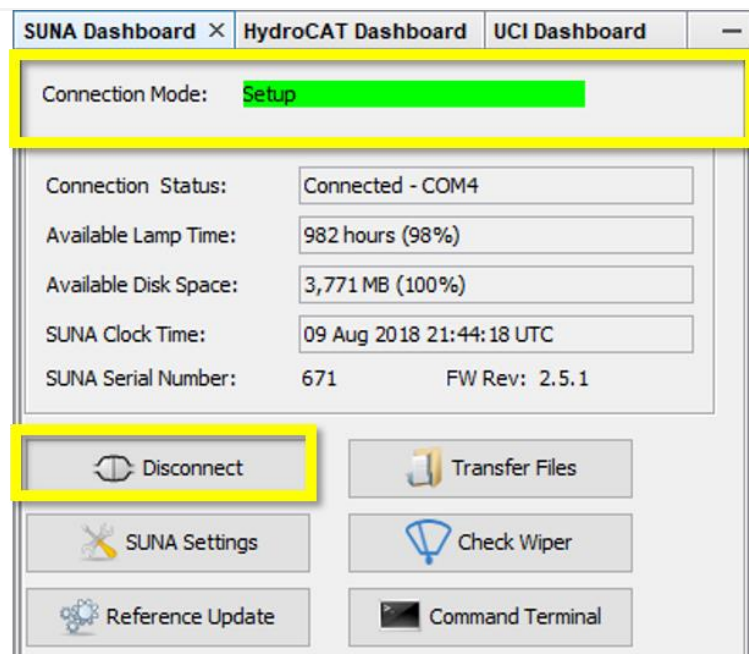

Figure 29. Successful Connection to SUNA

Indicators that the connection is successful are when the Connection Mode turns green and states **“Setup”**, and the **Connect** button changes to **Disconnect** (Figure 29).

Note: If the serial port connection fails on the SUNA, close the program and unplug the USB connection from the laptop. Plug it back in and start the process again. If still unsuccessful after a few attempts, power cycle the SUNA. Unplug the Y- cable from the SUNA bulkhead to disconnect the SUNA from power for 15-20 minutes. Re-attempt this procedure starting from Step 6. Further troubleshooting options are available in Section 9.

PRO TIP: If the software freezes, the laptop Bluetooth may be the culprit. Close the software, disable Bluetooth and restart this procedure. If the problem persists, reinstall the FTDI drivers (see Table 14) and try again. If you are unsure if a driver is necessary, look under the Laptop **Device Manager** under **Com Ports**. Installed drivers display the SUNA cable with **“SUNA”** in the name. If the COM Port is showing **“Serial USB Device”**, then the drivers are incorrect. If this occurs, download the FTDI drivers and restart this procedure.



Title: NEON Preventive Maintenance Procedure: Submersible Ultraviolet Nitrate Analyzer (SUNA)		Date: 03/22/2022
NEON Doc. #: NEON.DOC.002716	Author: R. Willingham, M. Cavileer, J. Csavina, D. Monahan, B. Hensley	Revision: D

5.4.3 Configure & Prepare SUNA

After connecting the SUNA to the UCI software in Section 5.4.2, change the SUNA operating mode and disable the wiper to allow for the application of the Parafilm for the validation process. Reference **Table 5** to complete these tasks.

Table 5. Drift Check Preparation: Switch Operational Mode & Disable Wiper.

STEP 1 | Acquire the necessary equipment to complete this procedure onsite. This includes powder-free nitrile rubber gloves, Parafilm, materials to equilibrate DI water onsite and cleaning supplies.

STEP 2 | Equilibrate fresh DI water in accordance with Section 5.4.1.2 DI Water: Field Equilibration Procedure on page 21.

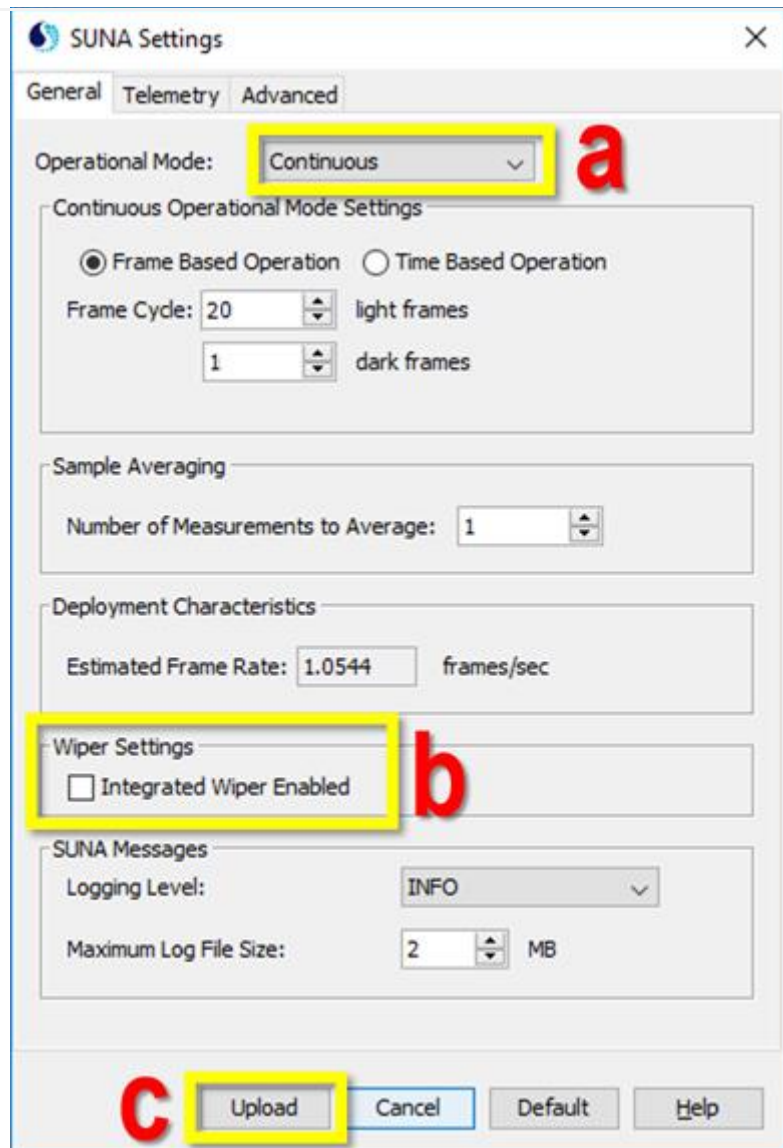

STEP 3 | Click the “SUNA Settings” button in the **SUNA Dashboard** window. (This button is under the **Connect** button in the previous procedure.)

STEP 4 | In the **SUNA Settings**, switch the **Operational Mode** from “Periodic” to “Continuous” (“a” in Figure 30).

STEP 5 | Under **Wiper Settings**, disable the wiper by unchecking the “Integrated Wiper Enabled” box (“b” in Figure 30).

STEP 6 | Verify that all options in the **SUNA Settings** are correct and click “Upload” to apply the changes made to the SUNA Settings (“c” in Figure 30).

Figure 30. Configure SUNA for Validation Process



Title: NEON Preventive Maintenance Procedure: Submersible Ultraviolet Nitrate Analyzer (SUNA)		Date: 03/22/2022
NEON Doc. #: NEON.DOC.002716	Author: R. Willingham, M. Cavileer, J. Csavina, D. Monahan, B. Hensley	Revision: D

STEP 7 | WEAR POWDER-FREE NITRILE GLOVES TO COMPLETE THE NEXT STEPS. *Even though these gloves state they are “Powder-free”, they may still contain some residue. Rinse the gloves in the stream until they are no longer slippery and then rinse with a little DI water.*



Figure 31. Physically Move Wiper on SUNA

STEP 8 | Manually move the wiper away from the optical area (Figure 31). Gently push the wiper up and out of the area of the optical window to prevent it from puncturing the Parafilm wrap when collecting nitrate readings.

 *Note: This step is also required when Field Science ships the sensor to HQ, CVAL for annual Sensor Refresh.*

STEP 9 | Create a DI reservoir in the optical window using Parafilm and equilibrated DI water.



Figure 32. Cut Parafilm to Size

STEP 9.1 | Cut and pre-stretch a 40cm piece of parafilm and carefully dry the area around the optical bench to enable a watertight seal (Figure 32).

 **PRO TIP:** *Pre-stretch the parafilm a little before wrapping it around the SUNA optical bench to enable a watertight seal on the first go. On cold days, place the parafilm in a pocket to keep warm before use.*



Figure 33. Wrap Parafilm around Optical Area of SUNA

STEP 9.2 | Wrap the Parafilm around the optical area of the sensor (Figure 33).

Ensure the Parafilm completely overlaps and that no wrinkle or voids (bubbles) that may cause the DI water to leak out of the wrapped optical area chamber. **It must be watertight.**

PRO TIP: It may be easier to wrap the Parafilm around the sensor when it is horizontal, as opposed to vertical in the graphic (Figure 33).

STEP 9.3 | Puncture a small hole through the Parafilm in the top area of the optical bench. Use a sharp, clean, pointed object to puncture the Parafilm, such as a clean plastic pipette tip.



Figure 34. Fill Optical Area with Equilibrated DI Water

STEP 9.4 | Gently fill the optical area with equilibrated DI water (Figure 34). Fill the area carefully to prevent water bubbles in the Parafilm.

Added pressure to puncture and fill the area may cause leaks and require you to restart this process. Employ caution when conducting this task.

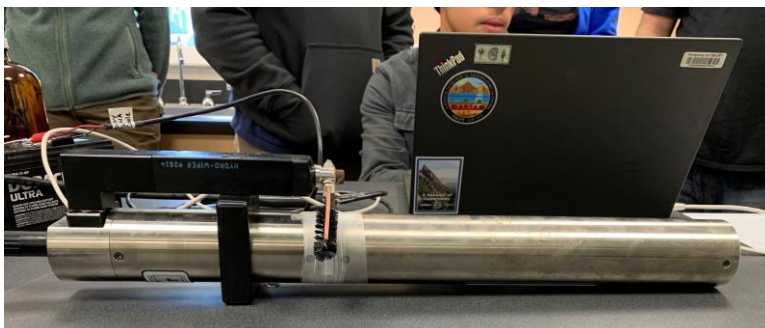

Figure 35. Validate SUNA Vertically to Prevent Bubbles on Optical Bench

STEP 9.5 | Set the sensor horizontally to prevent air bubbles from accumulating on the optical bench (Figure 35).



Title: NEON Preventive Maintenance Procedure: Submersible Ultraviolet Nitrate Analyzer (SUNA)		Date: 03/22/2022
NEON Doc. #: NEON.DOC.002716	Author: R. Willingham, M. Cavileer, J. Csavina, D. Monahan, B. Hensley	Revision: D

5.4.4 Conduct SUNA Drift Test

Sensor drift is the slow change in sensor measurement independent of the actual concentration of nitrate in the water. Tracking sensor drift is critical for correcting data and determining sensor lifespan. In using a known DI blank (0 mg/L) to measure pre- and post-cleaning nitrate values, we are able to track sensor drift and assess measurement quality appropriately. Reference **Table 6** to conduct this procedure.

Collect the pre-cleaning DI blank nitrate value BEFORE cleaning the optical area! Always wear clean, powder-free nitrile gloves when handling the SUNA.

5.4.4.1 Collect Pre-Cleaning DI Blank Nitrate Reading

Table 6. Collect Pre-Cleaning DI Blank Nitrate Reading Procedure.

<p>The screenshot shows the SUNA Dashboard interface. At the top, there are three tabs: 'SUNA Dashboard', 'HydroCAT Dashboard', and 'UCI Dashboard'. The 'SUNA Dashboard' is active. Below the tabs, the 'Connection Mode' is set to 'Setup', which is highlighted with a green background. A list of system status items includes: 'Connection Status: Connected - COM4', 'Available Lamp Time: 982 hours (98%)', 'Available Disk Space: 3,771 MB (100%)', 'SUNA Clock Time: 09 Aug 2018 21:44:18 UTC', and 'SUNA Serial Number: 671 FW Rev: 2.5.1'. Below these are several control buttons: 'Disconnect', 'Transfer Files', 'SUNA Settings', 'Check Wiper', 'Reference Update', 'Command Terminal', 'Start', and 'Replay Logged Data'. The 'Start' button is highlighted with a yellow border.</p>	<p>STEP 1 Press the “Start” button in the SUNA Dashboard to begin a real-time SUNA nitrate measurement (Figure 36).</p> <p>The Connection Mode will show “Acquisition” and stay green.</p> <p>The Spectra graph in the main UCI window will begin populating with data.</p>
<p>Figure 36. Press Start on the SUNA Dashboard</p>	
<p>STEP 2 Collect data for 1 minute by watching the time interval at the bottom of the graph until it reaches 60 seconds (Figure 37).</p>	

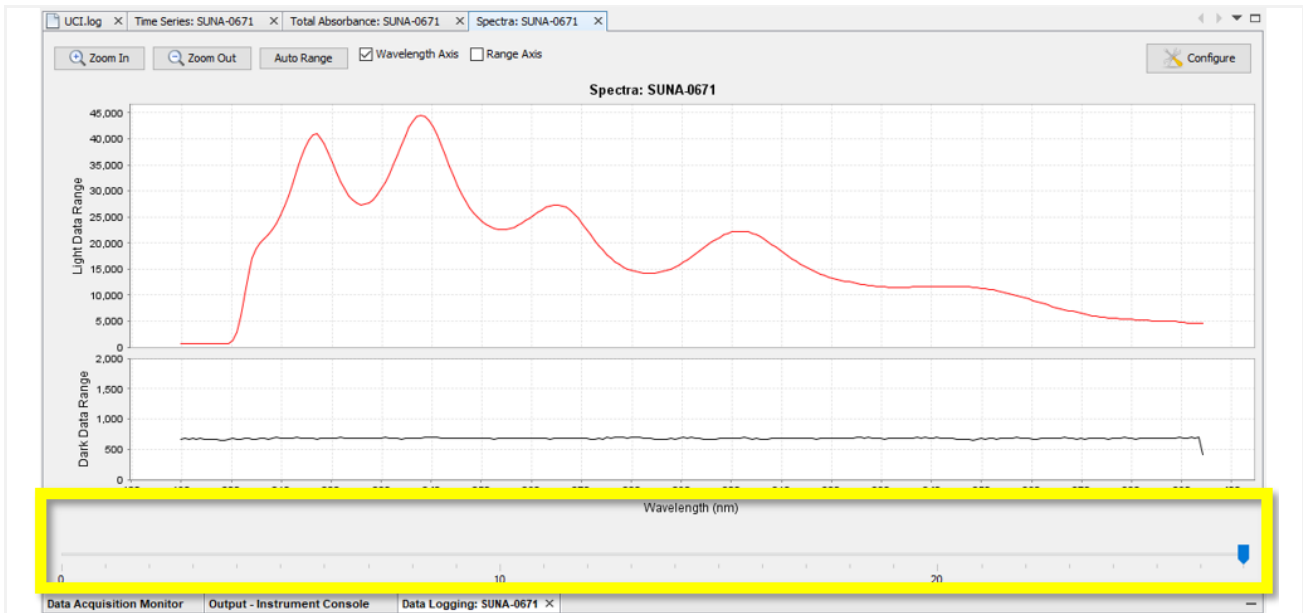

Figure 37. Collect Data for 1 Minute Monitoring the Wavelength Measurement

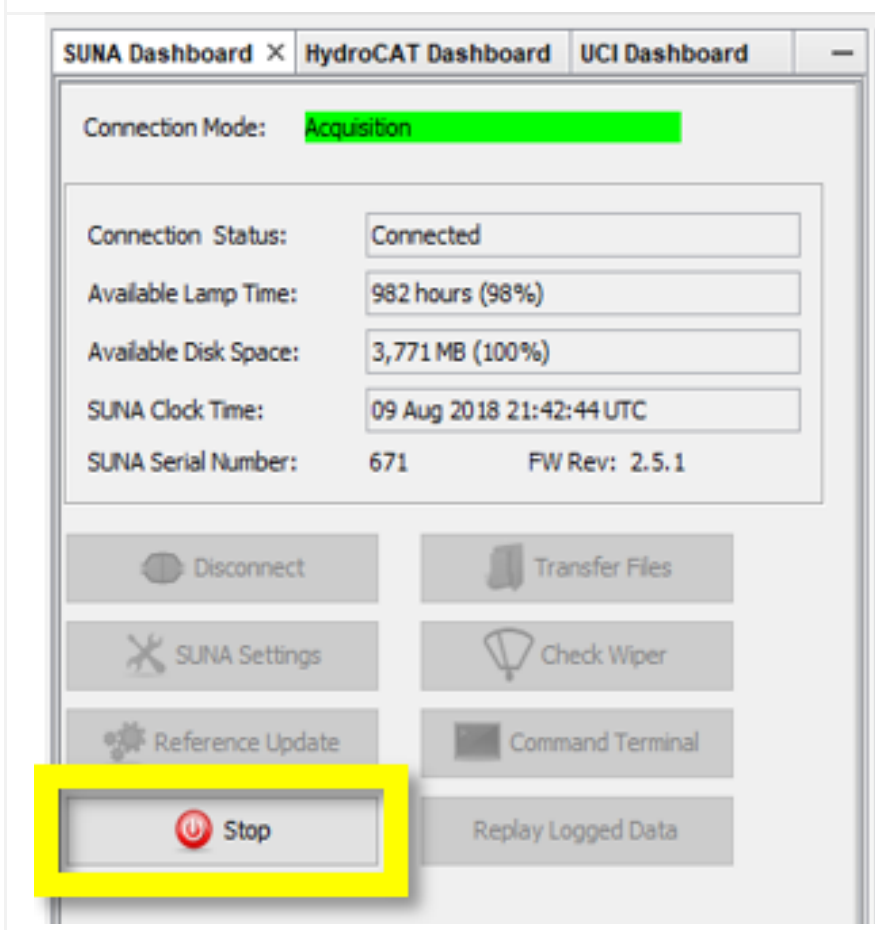

Figure 38. After 1 Minute, Click Stop

STEP 3 | After 1 minute, click "Stop" (Figure 38).

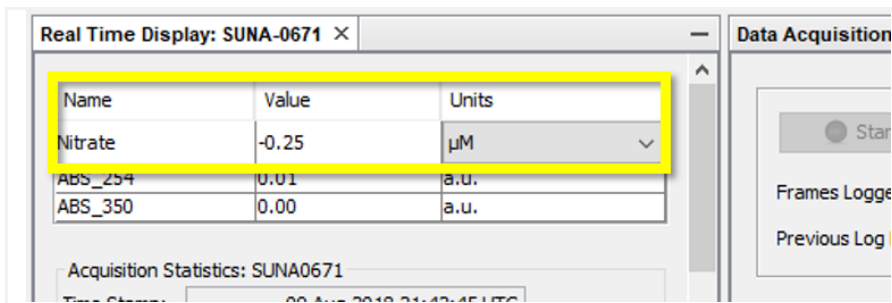

Figure 39. Record Real-Time Nitrate Measurement in Lower Left Corner

STEP 4 | The nitrate measurement displays in the bottom left-hand corner in the Real Time Display section (Figure 39).

Record the nitrate measurement value.

STEP 5 | Remove the Parafilm and drain the DI water from the dirty optical area.

STEP 6 | Clean the sensor following the guidance in Section 5.4.4.2. Clean the sensor regardless of the dirty measurement value to capture a clean measurement value per Section 5.4.4.3.

5.4.4.2 Clean SUNA

After collecting the dirty nitrate reading, clean the SUNA body and optical area.

1. With gloves still on, gently remove loose debris on the SUNA body by hand. Do not use your hands/fingers to remove any debris present in the SUNA’s optical bench. **NEVER insert your hands/fingers into the optical area.**
2. If there is stubborn debris/bio-fouling buildup on the SUNA body, use a scrub brush with vinegar. Ensure the scrub brush does not touch the optical area.
3. Clean the optical bench by flushing it with DI water.
4. Use Kimwipes/micro-fiber or lint-free cloths to carefully clean the optical window with isopropyl. **Employ caution when cleaning this area; do not scratch the surface of the windows!**

5.4.4.3 Collect Post-Cleaning DI Blank Nitrate Reading

Repeat the procedure in **Table 6** after cleaning the SUNA to collect a post-cleaning DI blank nitrate value. If the post-cleaning reading is $> \pm 2.00 \mu\text{M}$, re-clean the sensor and repeat. If the value is still $> \pm 2.00 \mu\text{M}$ after the second cleaning, perform a reference spectrum update (*see Section 5.6.1 below*), and then collect a new DI blank value. **This unplanned reference spectrum update should not affect or delay the scheduled monthly reference spectrum update.** If the value is still $> \pm 2.00 \mu\text{M}$, report the value to HQ via the NEON Program’s Issue Reporting and Management System to flag the data.

5.4.5 Revert SUNA Configuration

After conducting the validation procedure for drift, return the SUNA back to its deployment wiper and mode settings. Be aware, Technicians must manually move the wiper to its operational position (original position) and re-enable its settings in UCI. However, physically moving the wiper for drift tests every two weeks has the potential to affect the mechanical operation of the wiper over time. Small changes may compound and the sensor may require corrective action if the wiper is not manually moved correctly or carefully. Reference **Table 7** to revert the SUNA configuration for sampling.



Title: NEON Preventive Maintenance Procedure: Submersible Ultraviolet Nitrate Analyzer (SUNA)		Date: 03/22/2022
NEON Doc. #: NEON.DOC.002716	Author: R. Willingham, M. Cavileer, J. Csavina, D. Monahan, B. Hensley	Revision: D

Table 7. Test Wiper Function & Restore Original SUNA Settings for Measurement Collection.

STEP 1 | Manually return the SUNA wiper to its original position by carefully moving the wiper back to the edge of the optical window.

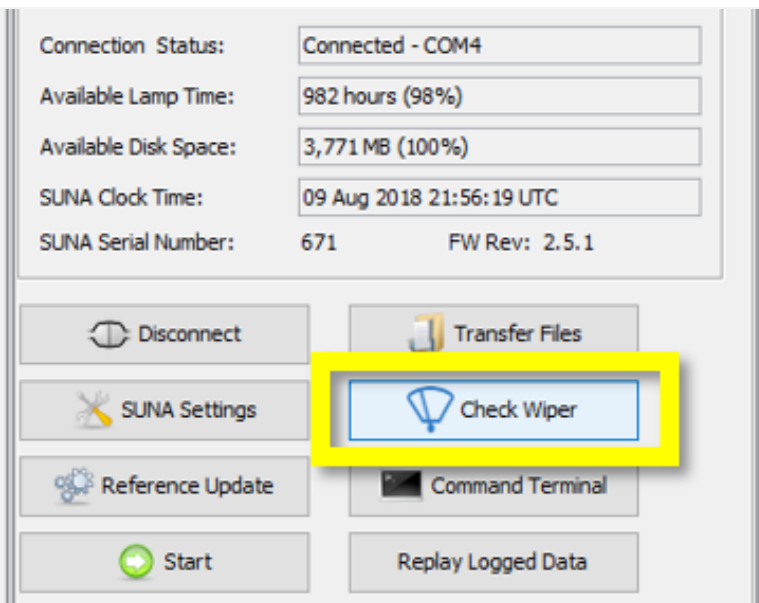

Figure 40. Select "Check Wiper"

STEP 2 | Verify wiper function by conducting wiper tests with the UCI software. Click on the "Check Wiper" button under the **SUNA Dashboard** (Figure 40).

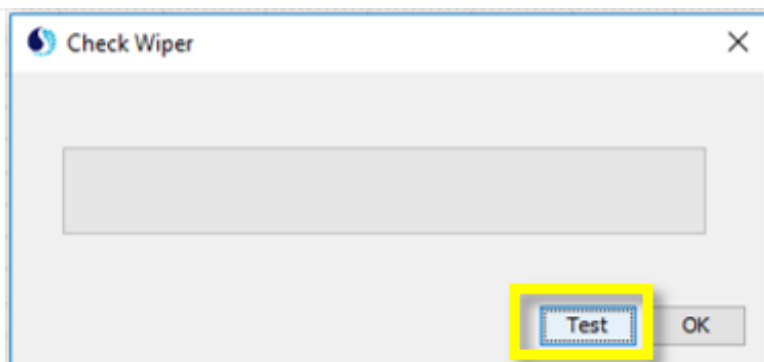

Figure 41. Select "Test" to Verify Wiper Function

STEP 3 | Select "Test" and watch the wiper move through the optical window (Figure 41).

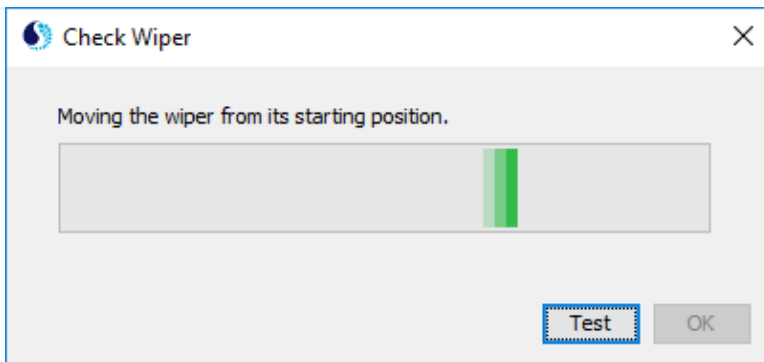

Figure 42. Monitor Wiper Movement

STEP 4 | Monitor the wiper movement during the function test (Figure 42). Pay careful attention to verify if the wiper is sweeping through the entire window, stopping halfway through, or gets stuck on the edge of the window and does not complete a wipe



Title: NEON Preventive Maintenance Procedure: Submersible Ultraviolet Nitrate Analyzer (SUNA)		Date: 03/22/2022
NEON Doc. #: NEON.DOC.002716	Author: R. Willingham, M. Cavileer, J. Csavina, D. Monahan, B. Hensley	Revision: D

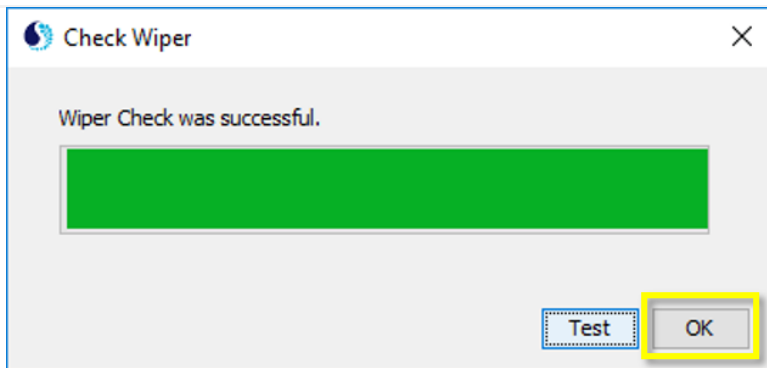

Figure 43. Select "OK" to Complete Wiper Test

STEP 5 | Select “OK” when the wiper check is complete (Figure 43).

Physically (with your hands) adjust the wiper, if necessary, to allow the wiper to perform a normal, full sweep of the optical window.

STEP 6 | Repeat the wiper check until the wiper successfully passes 3 to 4 tests in a row. If the wiper fails this check, it is likely the coupler, submit an incident ticket in the NEON Program’s Issue Reporting and Management System. **Do not remove a SUNA from the site for a broken wiper unless explicitly instructed by the AQU Science Team.** In most cases, bi-weekly manual cleaning should be sufficient to prevent impactful levels of biofouling until a replacement SUNA with working wiper is available.

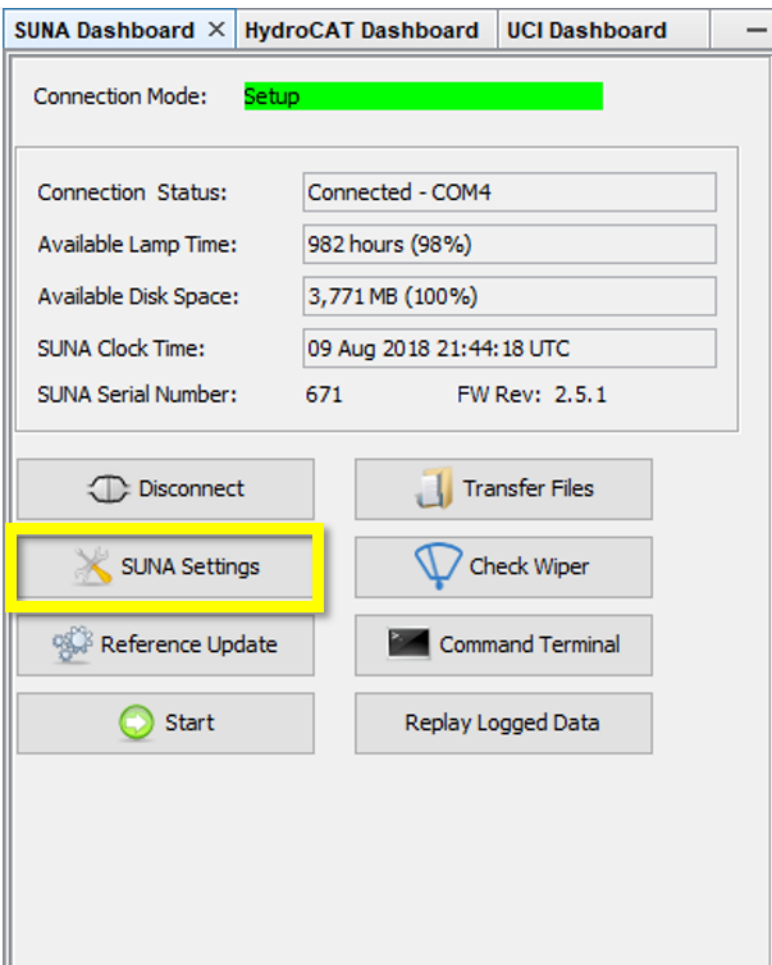

Figure 44. Select "SUNA Settings"

STEP 7 | Switch the **Operational Mode** back to “Periodic”, and re-enable the wiper.

Select the “SUNA Settings” button under the **SUNA Dashboard** (Figure 44).

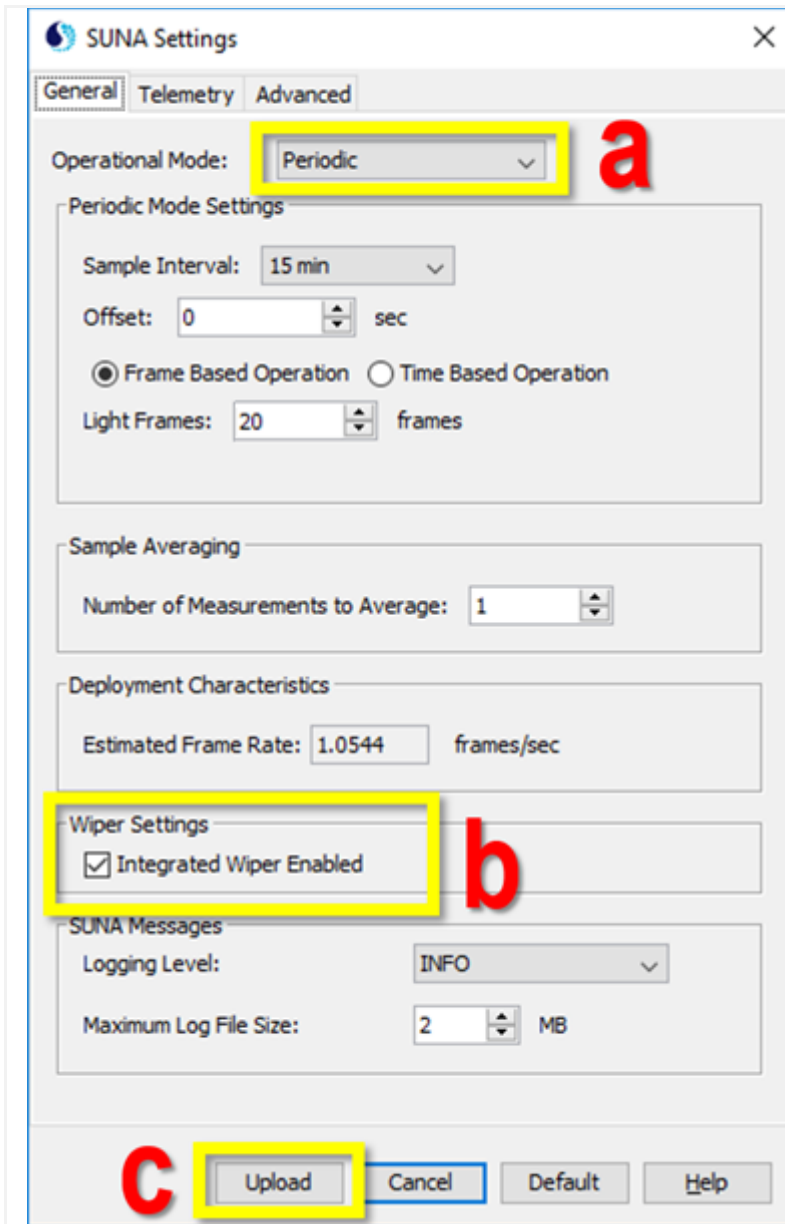

Figure 45. Return SUNA to Original Settings for Deployment

STEP 8 | In the **SUNA Settings** window, switch the **Operational Mode** from “Continuous” to “**Periodic**” (“a” in Figure 45).

STEP 9 | Under **Wiper Settings**, enable the wiper by checking the “**Integrated Wiper Enabled**” (“b” in Figure 45).

STEP 10 | Verify **SUNA Settings** window align with Figure 45.

Select “**Upload**” to apply the changes made to the SUNA Settings (“c” in Figure 45).



Title: NEON Preventive Maintenance Procedure: Submersible Ultraviolet Nitrate Analyzer (SUNA)		Date: 03/22/2022
NEON Doc. #: NEON.DOC.002716	Author: R. Willingham, M. Cavileer, J. Csavina, D. Monahan, B. Hensley	Revision: D

5.4.6 Available Lamp Time Verification

Check the “**Available Lamp Time**” in the **SUNA Dashboard** and record the hours to monitor lamp lifespan overtime (**Figure 46**).

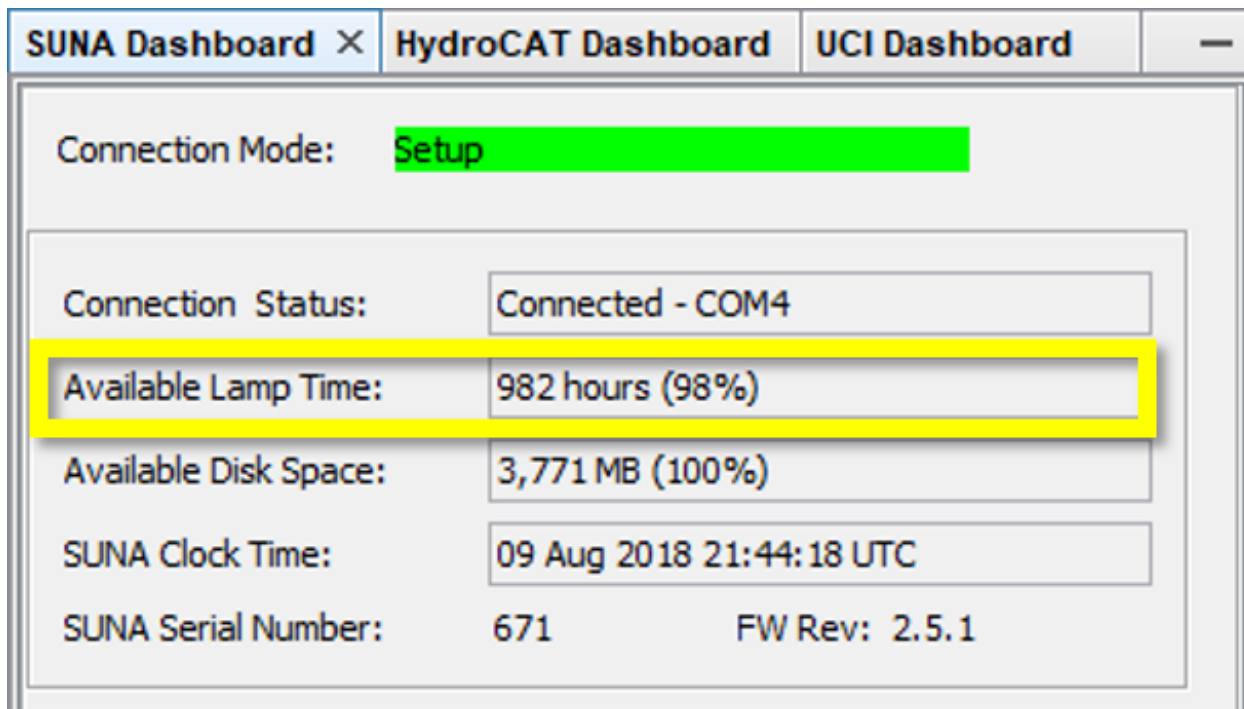

Figure 46. SUNA Dashboard: Available Lamp Time | Verify Lamp Time is > 50 Hours.

If the **Available Lamp Time** is **≤ 50 hours**, initiate SUNA sensor refresh by reporting the hours to CVAL, HQ via an incident ticket in the NEON Program’s Issue Reporting and Management System. Once a replacement sensor has arrived at the DSF, follow the instructions in Section 6 to replace the field sensor and return the SUNA with ≤ 50 hours of lamp life to CVAL for servicing.

5.4.7 Sensor Clock Synchronization

The SUNA internal clock drifts over time, especially the longer the instrument has been in the field. **It must be within ±30 seconds Universal Time Coordinated (UTC)** for the Location Controller (LC) to collect data from the SUNA. Use **Table 8** for instructions on synchronizing the SUNA internal clock. Synchronize the clock every time you connect to the SUNA for preventive maintenance.

Table 8. Synchronize SUNA Internal Clock to UTC.

STEP 1 From the main software window, use the “Sensor” dropdown menu to select SUNA > Advance > Set Clock (Figure 47).
--

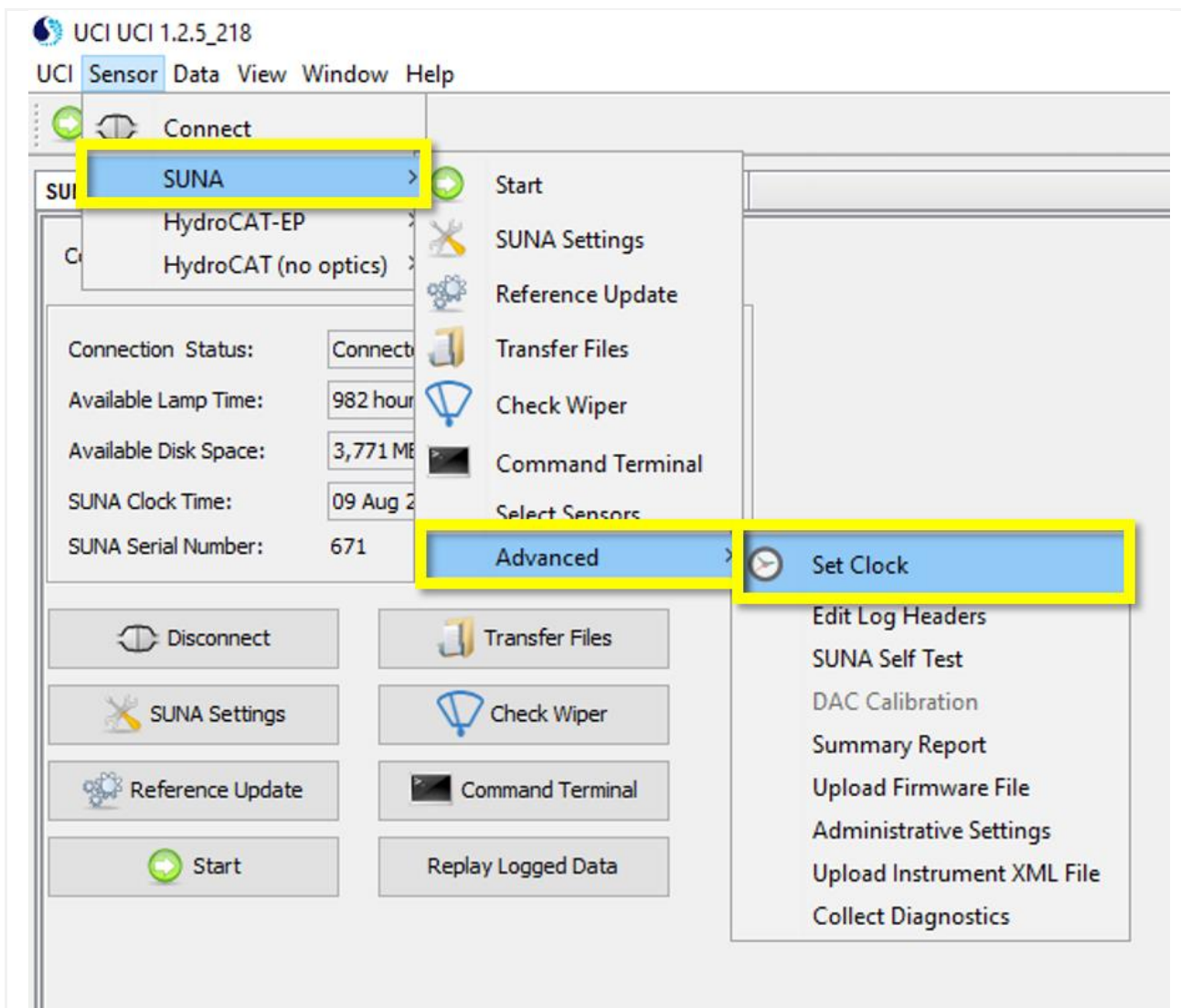

Figure 47. Use the "Sensor" Dropdown to Select "Set Clock"

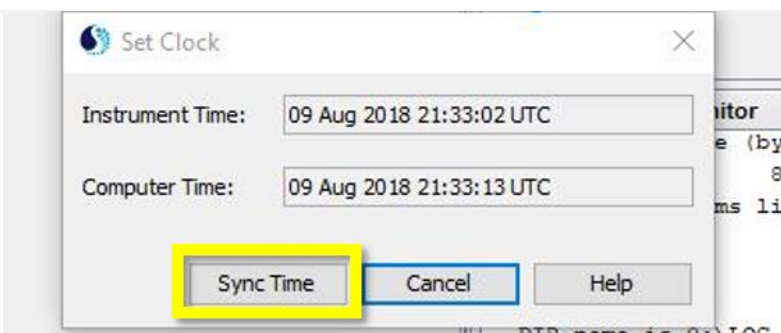

Figure 48. Select "Sync Time" to Automatically Update the SUNA Clock

STEP 2 | A **Set Clock** window opens. Click on "**Sync Time**" (Figure 48).

Note: The software automatically converts your computer local time to UTC. Ensure the laptop connecting to the SUNA is displaying the accurate local time. If unsure if it is accurate, google current local or UTC time or check the LC if internet access is not available.



Title: NEON Preventive Maintenance Procedure: Submersible Ultraviolet Nitrate Analyzer (SUNA)		Date: 03/22/2022
NEON Doc. #: NEON.DOC.002716	Author: R. Willingham, M. Cavileer, J. Csavina, D. Monahan, B. Hensley	Revision: D

5.4.8 Sensor Configuration Verification

Table 9 provides instructions to confirm the SUNA configuration is correct for deployment.

Table 9. How to Verify Sensor Configuration.

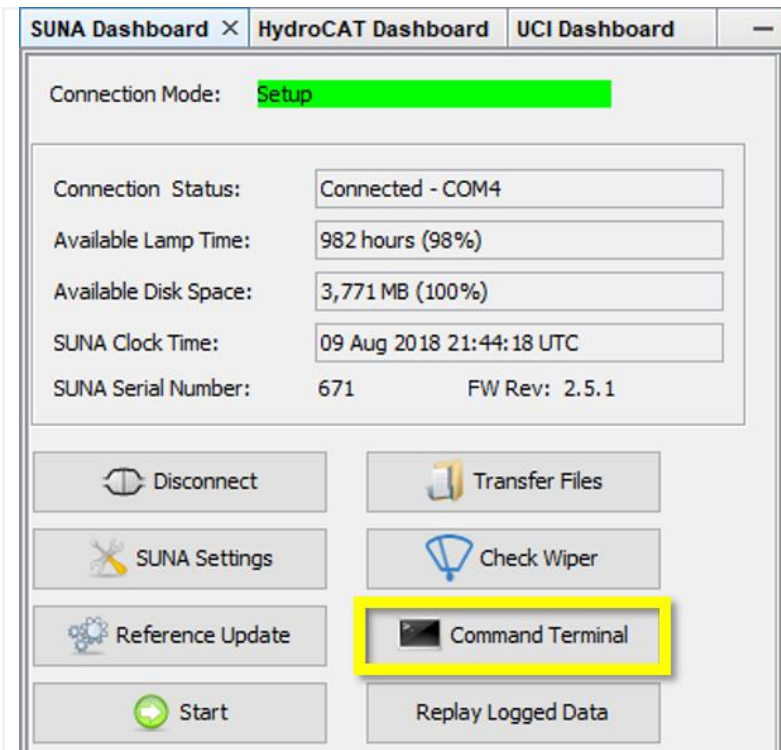

Figure 49. Open Command Terminal Window

STEP 1 | To verify the SUNA settings, click the “**Command Terminal**” button on the **SUNA Dashboard** (Figure 49).

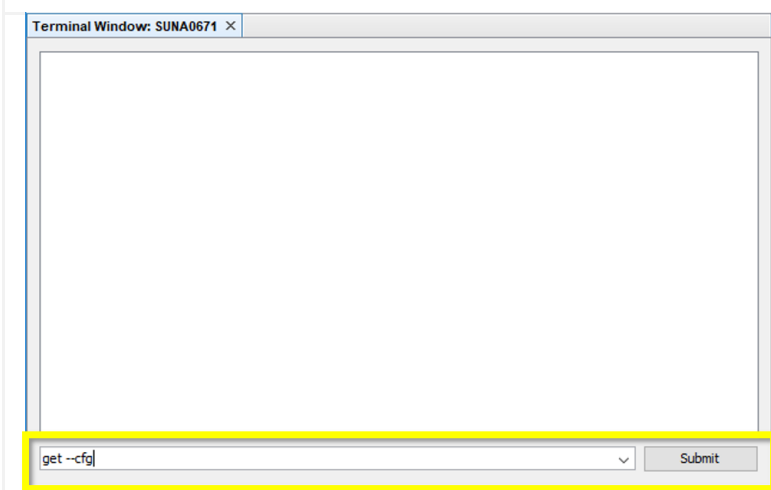
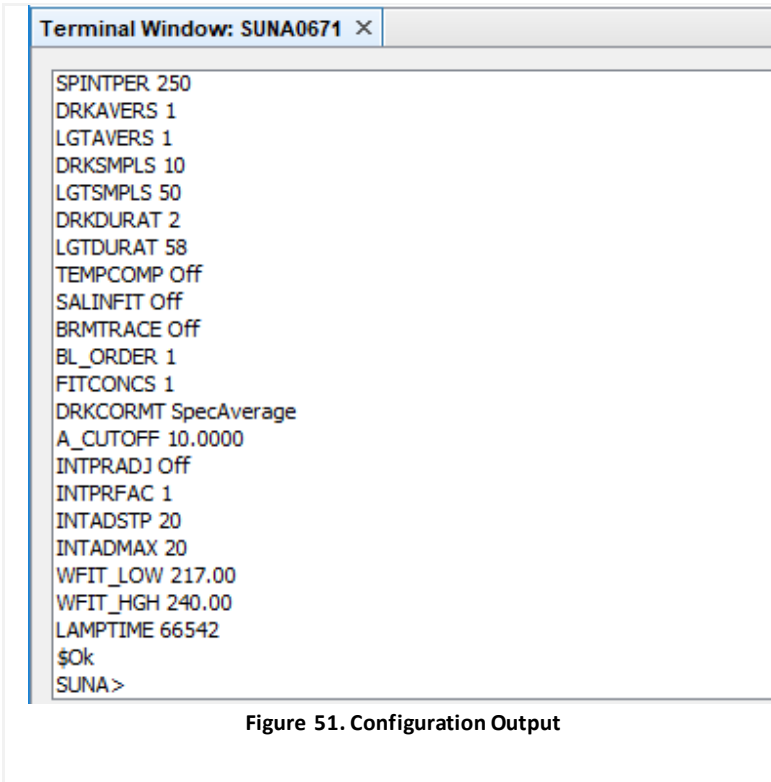

Figure 50. Select “get --cfg” from the Dropdown Command Prompt

STEP 2 | In the terminal window, select “**get --cfg**” from the dropdown command prompt and click **Submit** (Figure 50).



Title: NEON Preventive Maintenance Procedure: Submersible Ultraviolet Nitrate Analyzer (SUNA)		Date: 03/22/2022
NEON Doc. #: NEON.DOC.002716	Author: R. Willingham, M. Cavileer, J. Csavina, D. Monahan, B. Hensley	Revision: D



STEP 3 | This command lists the current configuration settings for the SUNA sensor (Figure 51).

These parameter values must match with the Parameter Values in the NEON Sensor Command, Control and Configuration (C3) Document: AIS Nitrate Analyzer via AD [04].

If the SUNA configuration settings do not match the configuration in AD [04], submit an incident ticket in the NEON Program’s Issue Reporting and Management System for guidance and assistance from CVAL and AIS Science.

Changing specific parameters can throw the sensor out of calibration; review AD [04].

PRO TIP: Good parameters to check are OPERMODE, OPERCTRL, PERDSMPLE, and DRKSMPLES.

5.4.9 SUNA Self-Test

Table 10. How to Conduct a SUNA Self-Test

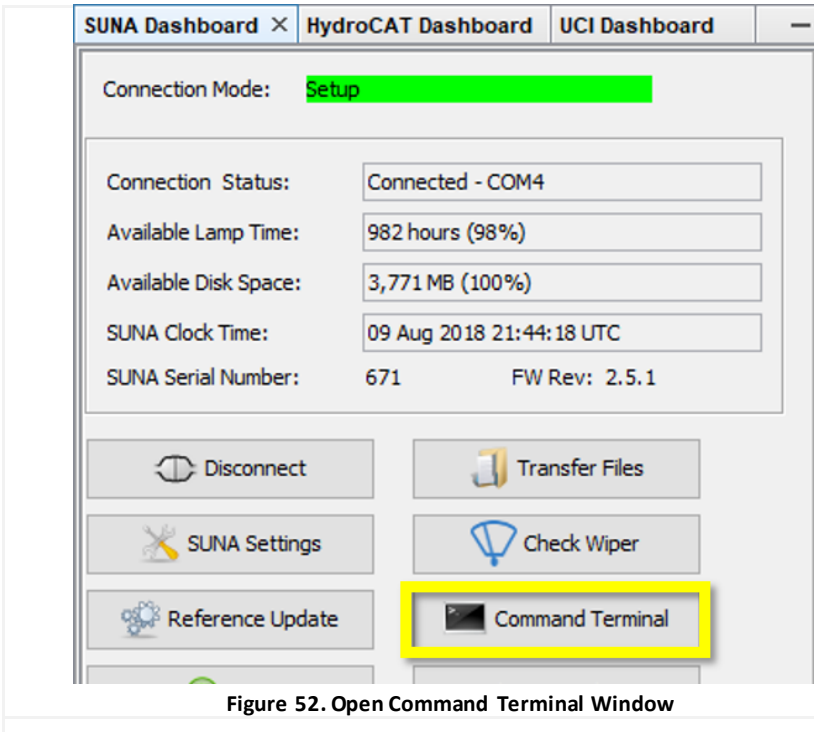

STEP 1 | To verify the function of the SUNA post-configuration setting changes or to verify the SUNA settings in general, click the “**Command Terminal**” button under the **SUNA Dashboard** (Figure 52).

Disregard this step if the **Terminal Window** is open from the previous configuration procedure (Table 9).



STEP 2 | Select the "SelfTest" command and click **Submit** (Figure 53).



Figure 53. Select "SelfTest" in the Terminal Window

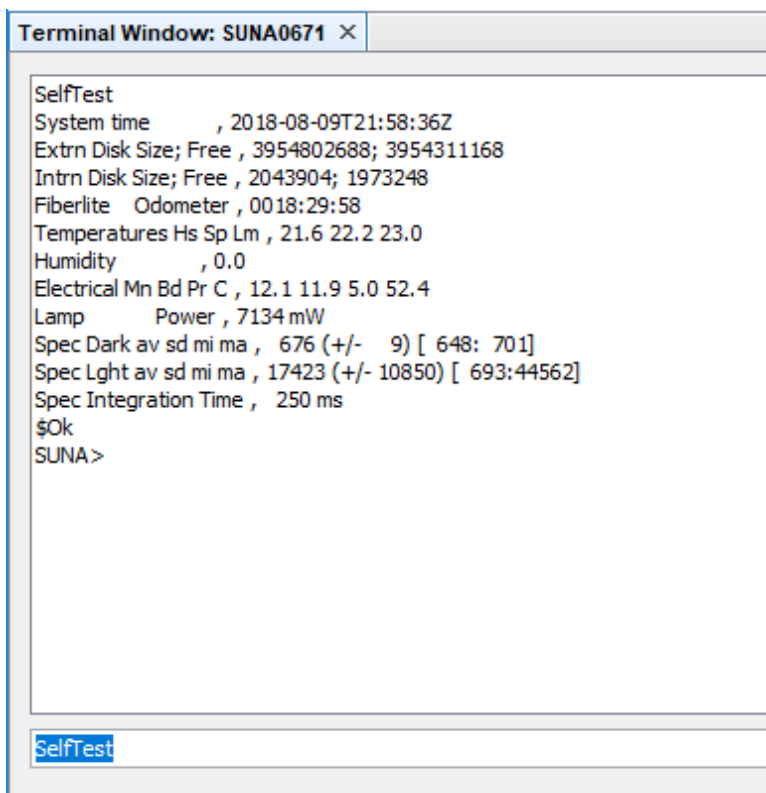

Figure 54. "SelfTest" Output Populates in the Terminal Window

STEP 3 | The "SelfTest" output populates in the command terminal (Figure 54).

Check this output for any "!", which indicate that the SUNA has a problem.

The internal humidity and temperature parameters for the SUNA are critical.

Humidity: This reports the internal humidity of the SUNA housing. An increase in this value over time indicates that the SUNA body has a leak somewhere and requires corrective action. A "!" means the water level inside the SUNA is high enough to cause a malfunction and/or damage.

Temperature: This reports the internal temperature of the SUNA housing. An increase in this value typically indicates that the lamp is activating for extended periods of time (such as when left in continuous mode after PM activities). A "!" means the internal temperature in the SUNA has been high enough to cause a malfunction and/or damage.

Spec Light av: When in DI, if the average (first number) is less than 10,000, it indicates low light reaching the detector. This may indicate an unclean window and/or DI contaminated with UV absorbing or scattering substances. Alternatively, it may indicate a degraded lamp. By tracking this value, we can determine if a lamp is degrading prematurely (i.e., faster than expected based on the cumulative lamp time). **This value will not always be flagged with "!" and should be verified manually.**



Title: NEON Preventive Maintenance Procedure: Submersible Ultraviolet Nitrate Analyzer (SUNA)		Date: 03/22/2022
NEON Doc. #: NEON.DOC.002716	Author: R. Willingham, M. Cavileer, J. Csavina, D. Monahan, B. Hensley	Revision: D

Submit a ticket in the NEON Program’s Issue Reporting and Management System if a “!” output is present on your SUNA. If the Spec Light av < 10,000, submit a ticket even if a “!” output is not present.

PRO TIP: As an aid for future troubleshooting, and to analyze SUNA performance changes over time, copy and paste SUNA humidity and temperature information into a log to keep track of the SUNA “SelfTest” output. This makes spotting an abnormal reading easier for these indicators. If the temperature reports -99.9!, run the self-test again. This reading is likely an error.

STEP 4 | Click the “X” in the upper right hand corner to close the Terminal Window when complete.

5.5 [CRITICAL PROCEDURE] Disconnect SUNA from Software and Hardware

Table 11. How to Properly Disconnect from a SUNA.

	<p>STEP 1 In the SUNA Dashboard, select the “Disconnect” button <u>BEFORE</u> disconnecting the USB connection from the laptop and cable from the SUNA (Figure 55).</p>
<p>Figure 55. In SUNA Dashboard, select “Disconnect”</p>	



Title: NEON Preventive Maintenance Procedure: Submersible Ultraviolet Nitrate Analyzer (SUNA)		Date: 03/22/2022
NEON Doc. #: NEON.DOC.002716	Author: R. Willingham, M. Cavileer, J. Csavina, D. Monahan, B. Hensley	Revision: D

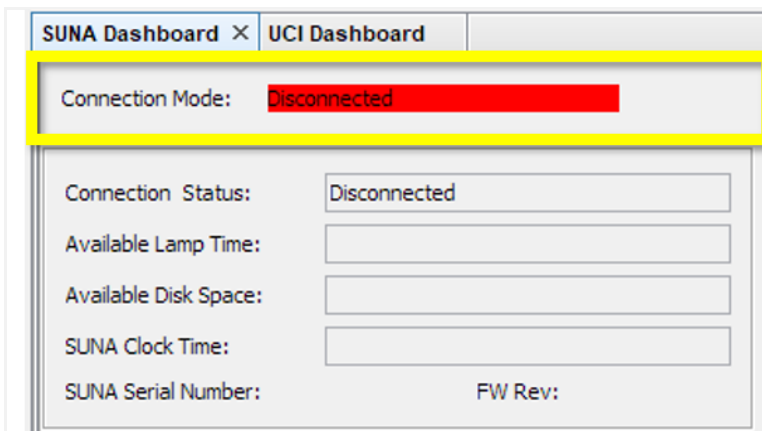

Figure 56. Confirm Connection Mode is Disconnected

STEP 2 | You must wait for the software to successfully disconnect from the SUNA; it will show the **Connection Mode** as “Disconnected” in red (Figure 56).

CAUTION: Disconnecting from the SUNA without this step leaves the SUNA in a state where it is unable to take measurements or transmit any data.

PRO TIP: If the SUNA was not properly disconnected, leave the SUNA unpowered (not plugged in to anything, no Grape or laptop) for 15-20 minutes. Afterwards, reconnect to the SUNA via the software. Re-verify the SUNA configuration settings and disconnect from the SUNA via the software. If the software is not disconnecting properly, or the SUNA is not streaming after verifying its configuration settings and allowing the Grape to reset for 5+ minutes, see Section 9 for additional troubleshooting guidance.

STEP 3 | Disconnect the SUNA calibration Y-cable.

At stream sites: Disconnect the 12V Merlot Grape from power (remove the RJF/Eth-to-Comm Ethernet cable powering the Grape). Once the Grape is no longer receiving power, disconnect the SUNA calibration Y-cable from the Grape and the SUNA. This prevents “hot-swapping” connections on the Grape, which may damage the Grape.

At buoy sites: disconnect the SUNA calibration Y-cable from the SUNA radio box and SUNA.

STEP 4 | Reinstall the SUNA following instructions in Section 6.2, Table 15.

STEP 5 | Reconnect the field SUNA power cable to its power source.

Stream sites: **Wait at least 5 minutes** after unplugging the SUNA calibration cable from the Merlot Grape after maintenance activities, and *BEFORE* reconnecting the SUNA power cable with its Merlot Grape for sensor redeployment. This is due to a timing issue for the Grape to resume communication with the LC, specifically for the SUNA. Failure to wait at least 5 minutes will not allow the Grape to reload the SUNA sensor, and results in loss of communication between the SUNA and LC, and subsequently, data loss.

PRO TIP: This is a common failure mode with this sensor, which results in a failure to stream data to the LC. Use PuTTY to Verify the SUNA Merlot Grape was able to reboot successfully. Execute the command “**nc localhost 30200**” in the terminal window. If “**GRAPE-SUNA**” appears in the output, the system was able to reboot and should stream (assuming the SUNA configuration settings are correct per AD [04]). If “**GRAPE-SUNA**” is not present in the output, power cycle the Merlot Grape for at least 5-10 minutes and check again.

Buoy sites: Reconnect the SUNA power cable to the SUNA radio box. The buoy power may remain on for SUNA maintenance activities.

STEP 6 | Verify that data is streaming again **before** leaving the site.



Title: NEON Preventive Maintenance Procedure: Submersible Ultraviolet Nitrate Analyzer (SUNA)		Date: 03/22/2022
NEON Doc. #: NEON.DOC.002716	Author: R. Willingham, M. Cavileer, J. Csavina, D. Monahan, B. Hensley	Revision: D

5.6 Monthly Validation/Calibration Procedure

Always conduct a monthly calibration of the SUNA in the field, along with the biweekly field validation (Section 5.4). Updating the reference spectrum at least once a month corrects for lamp degradation.

During routine maintenance (cleaning only), if the post-cleaning value is $> \pm 2 \mu\text{M}$ after two attempts, then field science must update the SUNA reference spectrum with the instructions in Section 5.6.1 in **Table 12**. *This update will not affect or delay the scheduled monthly update.* If the post-cleaning nitrate value is still $> \pm 2 \mu\text{M}$, reinstall the sensor on site.

During a scheduled calibration (reference spectrum update), begin with the routine maintenance in Section 5.4. Regardless of the post-clean value, begin the reference spectrum update procedure in Section 5.6.1 below. If after the first reference spectrum update, the nitrate value is $> \pm 2 \mu\text{M}$, attempt to clean the optical window again and perform a second and final update. Regardless of the results, reinstall the sensor onsite. If the final update did not fall within the acceptable parameters, submit an incident ticket soliciting advice from the AQU Science team.

IMPORTANT: Download all SUNA calibration files to the Network Drive for HQ Aquatic Science. Download files to N:\Common\CVL\Field_Calibration\Field_Calibration_Data within 5 days of calibration. *If the SUNA calibration files are not downloaded, the SUNA data from the site will be flagged.*

5.6.1 Monthly Calibration: Reference Spectrum Update Procedure

Conduct the procedure in Table 12 to calibrate the SUNA.

Table 12. Monthly Calibration Validation: Reference Spectrum Update Procedure

	<p>STEP 1 In the SUNA UCI software application, select “Reference Update” on the SUNA Dashboard (Figure 57).</p>
<p>Figure 57. Click on the “Reference Update” on SUNA Dashboard</p>	<p>STEP 2 Follow the prompts in Reference Update Wizard. Clean the windows with a Kimwipes and isopropyl alcohol. Apply pre-stretched Parafilm around the optical section. Place DI Water into the sampling volume (same steps as the Field Validation procedure). Ensure there are no air bubbles sticking to the windows (“a” of Figure 58). After, click “Next >” to move to Step 2 of 4 (“b” of Figure 58).</p>

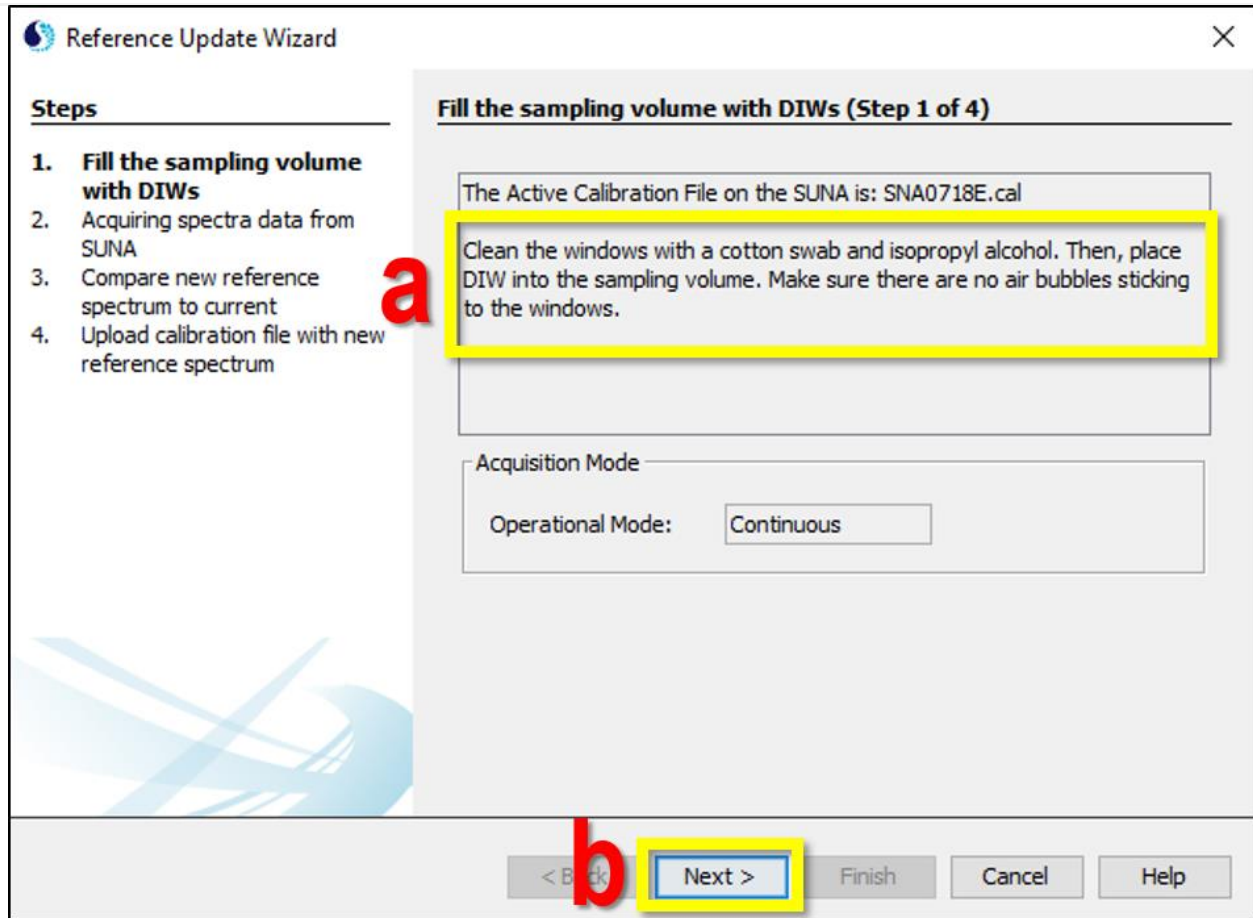

Figure 58. Reference Update Wizard Step 1 of 4: Fill the Sampling Volume with DIWs

STEP 3 | For Step 2 of 4 in the Reference Update Wizard, the software acquires spectra data from the SUNA. This process does not require any actions except to wait until it is complete before clicking next (Figure 59).

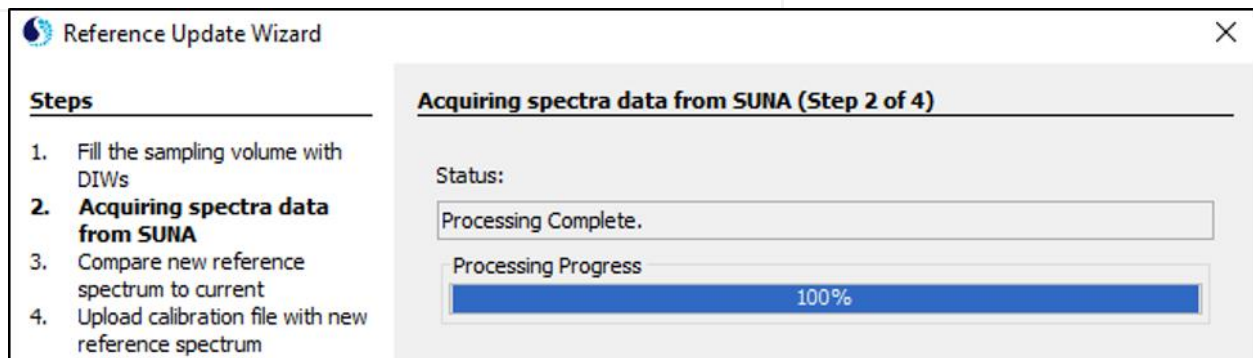

Figure 59. Reference Update Wizard Step 2 of 4: Acquiring Spectra Data from SUNA

STEP 4 | For Step 3 of 4 in the Reference Update Wizard, accept the percent change (Figure 60). Select "Next >" when complete. **If the percent change is < -20% or > 5%, the SUNA has failed calibration. Clean and update spectrum twice, after the second failed attempt, still accept reference update but submit an incident ticket with a screen capture of this Step, in addition to a copy of the new calibration file and**



Title: NEON Preventive Maintenance Procedure: Submersible Ultraviolet Nitrate Analyzer (SUNA)		Date: 03/22/2022
NEON Doc. #: NEON.DOC.002716	Author: R. Willingham, M. Cavileer, J. Csavina, D. Monahan, B. Hensley	Revision: D

calibration PDF (Step 6 below). Complete the calibration (**Steps 3-8** below) even if the percent change is outside the allowable range. A large change in the reference spectrum can, but does not always, indicate a problem with the SUNA lamp. The AIS Science Team will evaluate the incident and advise whether to try another calibration or pull the sensor from the stream next time onsite.

PRO TIP: The expected amount of lamp degradation is proportional to the run time. Therefore, SUNAs that have gone longer without updates (for example sites under the ice during winter) are more likely to exhibit a large percent change in the reference spectra. Exposure to high temperatures can also cause the lamp to degrade faster. Even though these cases are to be expected, still submit incident tickets.

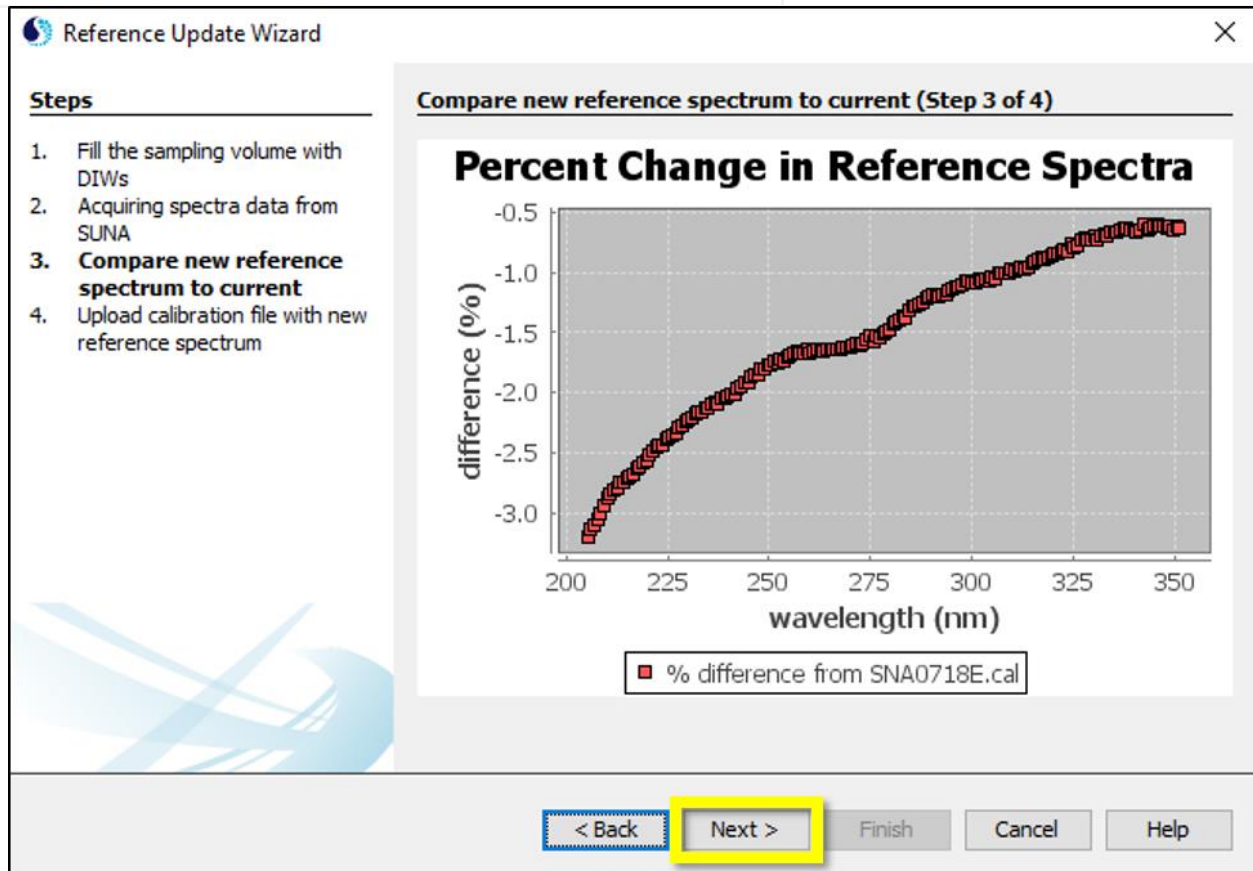

Figure 60. Reference Update Wizard Step 3 of 4: Compare New Reference Spectrum to Current

STEP 5 | Save the calibration file with the new reference spectrum locally on the PC laptop in **C:\Test_Data\Suna_Data**. If this folder is not present, create one. Click **“Finish”** to upload the new Reference Spectrum into the SUNA (Figure 61).



Title: NEON Preventive Maintenance Procedure: Submersible Ultraviolet Nitrate Analyzer (SUNA)		Date: 03/22/2022
NEON Doc. #: NEON.DOC.002716	Author: R. Willingham, M. Cavileer, J. Csavina, D. Monahan, B. Hensley	Revision: D

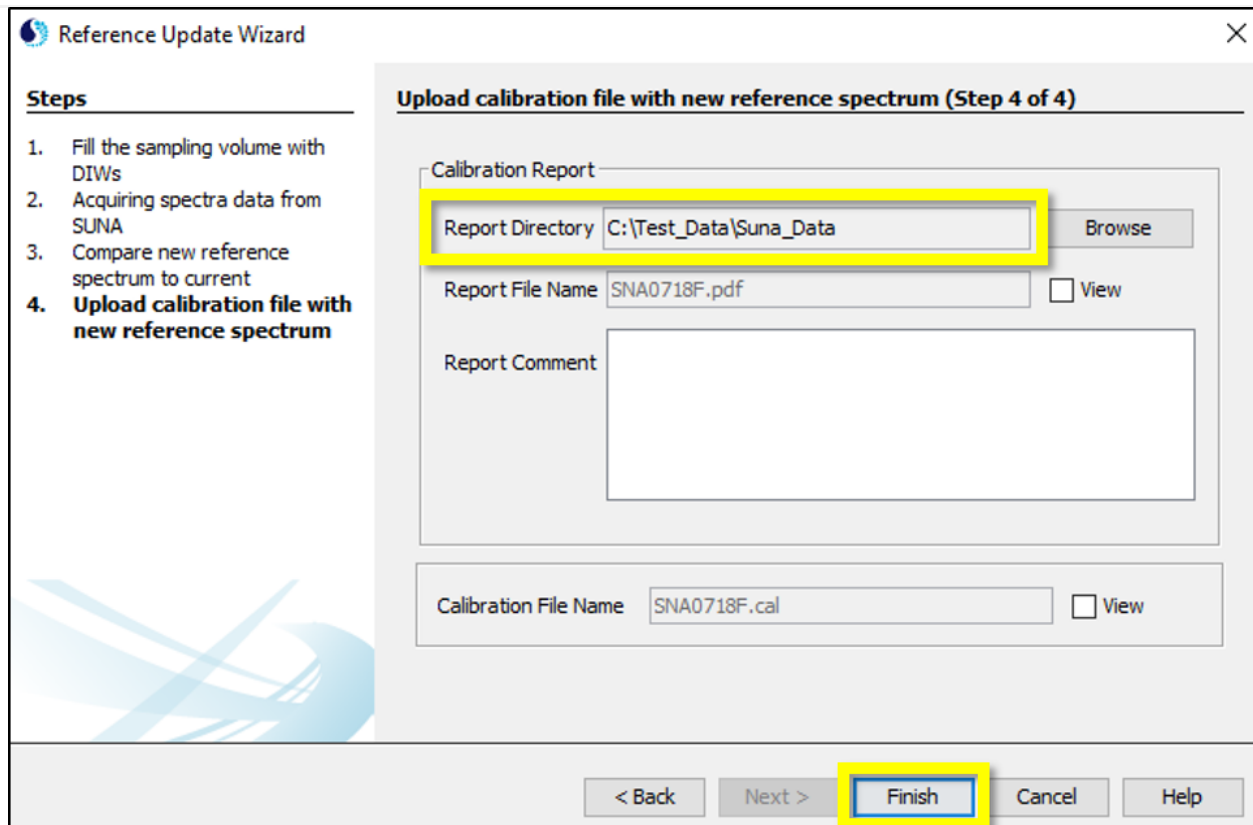

Figure 61. Reference Update Wizard Step 4 of 4

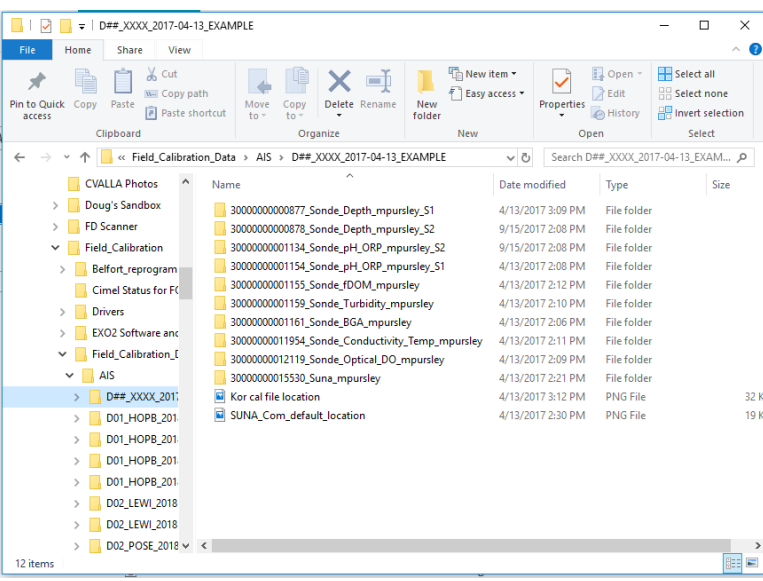

Figure 62. N:\Common\CVL\Field_Calibration\Field_Calibration_Data\AIS

STEP 6 | Move the calibration file to the project Network Drive folder for CVAL Field Calibration Data (Figure 62).

After saving the SUNA calibration file locally on your laptop, move the .cal file to here:

N:\Common\CVL\Field_Calibration\Field_Calibration_Data\AIS

Create a folder, if the current date does not exist for the SUNA.

Example Folder Naming Convention:
D01_HOPB_2018-07-03



Title: NEON Preventive Maintenance Procedure: Submersible Ultraviolet Nitrate Analyzer (SUNA)		Date: 03/22/2022
NEON Doc. #: NEON.DOC.002716	Author: R. Willingham, M. Cavileer, J. Csavina, D. Monahan, B. Hensley	Revision: D

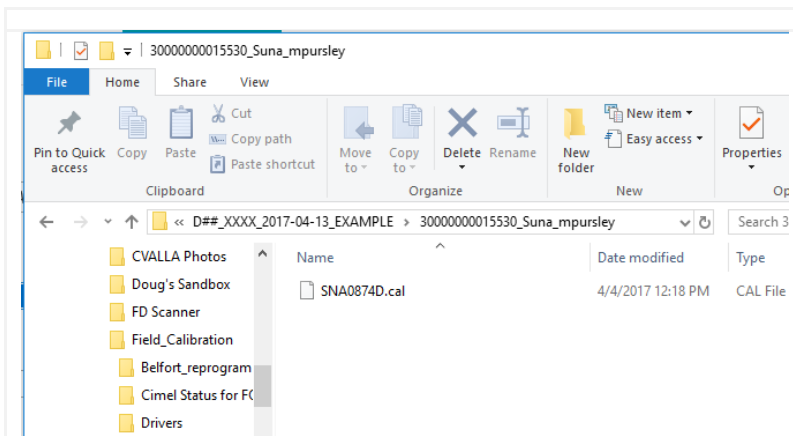

Figure 63. 30000000015530_SUNA_mpursley

STEP 7 | Once inside the correct **DOMAIN/SITE/DATE** folder, create a folder for the calibration data. Use the following naming convention:

ASSETNUMBER_SUNA_yourname

For example, **“30000000015530_SUNA_mpursley”** in Figure 63.

Save the calibration file inside your respective folder, leaving the default **.cal** file name (e.g., SNA0874D.cal).

PRO TIP: *Uploading calibration files to the Network Drive is important because otherwise the final data will be flagged as invalid.*

STEP 8 | After updating the reference spectrum graph, run a new DI blank following the procedures in Section 5.4.

If the nitrate value is $> \pm 2 \mu\text{M}$, repeat the process for the monthly reference spectrum update starting from Step 1 in Table 12. If the SUNA fails to meet the threshold again, reinstall the sensor and immediately submit a trouble ticket for further guidance.

If the nitrate value is $< \pm 2 \mu\text{M}$, return the SUNA to site/installation in stream or on the buoy as soon as possible to continue sampling.

STEP 9 | Verify that data is streaming again **before** leaving the site.

5.7 Seasonal Maintenance (Stream Sites)

This section addresses seasonal changes in stream flow that may affect the sensor function and data collection. Per aquatic science requirements, sensors and infrastructure shall be installed and adjusted seasonally, as directed by HQ and according to the preventative maintenance documentation, such that water quality, temperature and nutrient measurements shall be captured at 60% ($\pm 20\%$) of the total water depth at wadeable stream sites, excluding temporary changes in water depth which may be large and rapid due to storm events. Conduct the following actions to address the scenarios in **Table 13** to ensure sites maintain compliance with AIS science requirements. Reference AD [07] for thresholds and seasonal guidance on the sensors that mount to the AIS Buoy.



Title: NEON Preventive Maintenance Procedure: Submersible Ultraviolet Nitrate Analyzer (SUNA)		Date: 03/22/2022
NEON Doc. #: NEON.DOC.002716	Author: R. Willingham, M. Cavileer, J. Csavina, D. Monahan, B. Hensley	Revision: D

Table 13. Seasonal Maintenance: Stream Flow Changes.



Figure 64. Dry Stream Bed – SENSOR REMAINS IN DRY STREAM

SCENARIO 1 | As mentioned above, Per aquatic science requirements, the SUNA must maintain a water depth of 60% (with \pm 20% of flexibility).

If the stream dries up (Figure 64), **do not remove the sensor**. Create an incident in the NEON Program’s Issue Reporting and Management System to inform AIS Science that the site is dry. The data requires data quality flags during dry conditions. The brush may also be disabled remotely or onsite by HQ or at the direction of HQ. When water returns, report it in the same incident and resolve the incident.



Figure 65. SUNA Partially Submerged in Stream

SCENARIO 2 | Figure 65 is an example of a SUNA partially submerged. For this scenario, conduct the following assessment.

If the SUNA enclosure is breaching the water surface, move the mount further down the stream anchor to submerge the sensor in the stream flow. This will affect the Multisonde depth, too and require adjustments, as well. The SUNA and Multisonde must maintain the same depth.

If the stream flow is too low to allow adjustments, leave the sensor as-is and submit a ticket to notify AIS Science Staff to flag for data quality.

 *Note: Only make this adjustment for the SUNA. **Do not move the Level TROLL**. The Level TROLL must remain in a consistent location per NEON.AIS.4.1758.*



Title: NEON Preventive Maintenance Procedure: Submersible Ultraviolet Nitrate Analyzer (SUNA)		Date: 03/22/2022
NEON Doc. #: NEON.DOC.002716	Author: R. Willingham, M. Cavileer, J. Csavina, D. Monahan, B. Hensley	Revision: D



Figure 66. Winter Season Ice Accumulation

SCENARIO 3 | Per NEON.AIS.4.1314, aquatic-based sensor infrastructure shall be removed from select lake and wadeable stream sites prior to ice formation that could result in structural damage.

If the ice is only on the surface, the sensors remain onsite, in these situations (all lower 48 non-lake sites) leave under ice and snow, do not dig and or chip out to perform a PM, unless otherwise directed by HQ

For D18 Oksrukuyik Creek (OKSR): See RD [10]. Remove the stream sensors when the site alternate power system is OFF for the winter season.

If Field Science is aware that the stream may completely freeze (ice down to the substrate; no water flowing) under within 2 weeks/before the next site visit, remove the sensor from site.

See AD [07] for lake and river guidance.



Figure 67. NEON.D07.LECO.DP1.20002 High Flow Events

SCENARIO 4 | For imminent high-flow events, such as Figure 67, the site may not be safe to access. Consult with the NEON program safety office and AIS science staff for guidance.



Title: NEON Preventive Maintenance Procedure: Submersible Ultraviolet Nitrate Analyzer (SUNA)		Date: 03/22/2022
NEON Doc. #: NEON.DOC.002716	Author: R. Willingham, M. Cavileer, J. Csavina, D. Monahan, B. Hensley	Revision: D

6 REMOVAL AND REPLACEMENT (SUBSYSTEM ONLY)

6.1 Equipment

Table 14. Equipment for Sensor and Subsystem Removal and Replacement.

Maximo No.	Description	Quantity
Tools		
GENERIC	Open Ended Wrenches	Set
MX109759	Ratchet set	Set
MX109746	Allen Wrenches (5/16 Allen Wrench to remove SUNA enclosure)	Set
MX101649	Greenlee 0254-40 10 Pc T-Handle Hex Key Set	1
MX101639	Screwdriver set (flathead screwdriver to open Combo boxes)	1
MX102345	Measuring Tape	1
MX105024	Torque Wrench	1
NEON, Safety	Aquatic PPE	A/R
MX101632	PETZL Headlamp, Wide Beam, Gray	1
NEON, Safety	LOTO Equipment	A/R
MX102703	Digital Multi-Meter (DMM)	1
MX109755	Flush cut pliers or scissors (to remove zip ties)	1
MX102767	11-in-1 Screwdriver/Nut driver w/Interchangeable Blade	1
MX104238	SK Alum Edge Folding Utility Knife w/Belt Clip, Blue 3.5"	1
MX103120	Anti-static wristband	1
Consumable items		
	UV-resistant Zip ties	A/R
MX105865	3M Bag, ESD Shielded, 8 inch x 11 inch, Cushioned	1
MX105931	3M Bag, ESD, Static Shield, 6 x 8 Inches, Zip Closure, Non-Cushioned	1
MX105864	3M Bag, ESD Shield, 6 Inch X 7 Inch, Cushioned	1
MX105866	3M Bag, ESD Shielded, 14 Inch X 15 Inch Cushioned	1
MX105935	3M Bag, ESD, Static, 15 x 18 Inches, Zip-Closure Top	1
GENERIC	Masking tape	Roll
GENERIC	Sharpie/Paint pen	1
GENERIC	Boxes (to transport non-decontaminated sensors back to Domain)	A/R

 *Note: Maintain original product packaging, if possible, for use in future sensor swaps (calibration and validation), temporary storage, or to return faulty equipment.*

6.2 Removal and Replacement Procedure

The Field Operations Manager is responsible for managing the removal and replacement of the sensors onsite for preventive maintenance and/or sensor swaps, as well as field calibration and validation of sensors, as appropriate. CVAL is responsible for the annual calibration and validation of select sensors and manages the Domain sensor swap schedules. **Reference RD [08] for the standard operating procedures for the annual Sensor Refresh process and delineation of sensor, administrative and logistical requirements.**



Title: NEON Preventive Maintenance Procedure: Submersible Ultraviolet Nitrate Analyzer (SUNA)		Date: 03/22/2022
NEON Doc. #: NEON.DOC.002716	Author: R. Willingham, M. Cavileer, J. Csavina, D. Monahan, B. Hensley	Revision: D

To minimize data downtime and optimize the availability of sound data, coordinate instrumentation and subsystem **annual** calibration, validation and preventive maintenance requirements to occur within the same timeframe.

6.2.1 Stream (S2) Sites

Conduct the following removal and replacement procedures for the SUNA at wadeable stream sites in Table 15. Reference AD [08], NEON.DOC.003880 NEON Preventive Maintenance Procedure: AIS Stream Infrastructure for additional information to support or compliment this procedure.

Table 15. SUNA Removal & Replacement Procedures for Stream Sites.



Figure 68. AIS Combination Box - 5 Amp Breakers

STEP 1 | Power down S2 from the Combo Box. Use a flathead screwdriver to open the Combo box (Figure 68).

Reference AD [10] for additional guidance on the AIS power distribution system.



Title: NEON Preventive Maintenance Procedure: Submersible Ultraviolet Nitrate Analyzer (SUNA)		Date: 03/22/2022
NEON Doc. #: NEON.DOC.002716	Author: R. Willingham, M. Cavileer, J. Csavina, D. Monahan, B. Hensley	Revision: D



Figure 69. SUNA 12V Merlot Grape Subsystem

STEP 2 | Disconnect the Ethernet Cable (RJF/Eth to Comm on AIS Interconnect Mapping) from the 12V Merlot Grape that powers and acquires data from the SUNA (Figure 69). Drape the cable over the anchor. Do not allow the cable connector to get wet or dirty.

Reference AD [06] for AIS Grape Mapping.

***i** Note: Always remove the Ethernet cable from the Grape prior to connecting and disconnecting sensor cables; this de-energizes the Grape (data acquisition device) to prevent damage to the mechanism.*

STEP 3 | Remove the 12V Merlot Grape for Sensor Refresh. Remove the four screws that affix the Grape to the Grape Shield using a hex wrench.

It may be easier to remove the Grape Shield(s) from the anchor Unistrut to prevent losing the four screws that secure the Grape to the shield. Use a 3/16" hex wrench to remove the entire assembly with the Grape. Store Grapes without caps in an ESD bag.

STEP 4 | Using a 5/16th Allen wrench, remove the SUNA PVC enclosure from the in-stream anchor (Figure 70). Remove the bolts connecting the L Bracket to the Unistrut. Be aware, you will need to catch the nut on the screw before it falls off and flows downstream. In the event you do lose a nut, order spares (0329850000Nut, Channel w/o spring retainer, 3/8-16 Stainless). It is also OK to pull out the locking pins and slide the sensor out from the enclosure, along with the captive discs; however, this method may make it harder to align the captive discs with the pinholes on the PVC enclosure underwater.

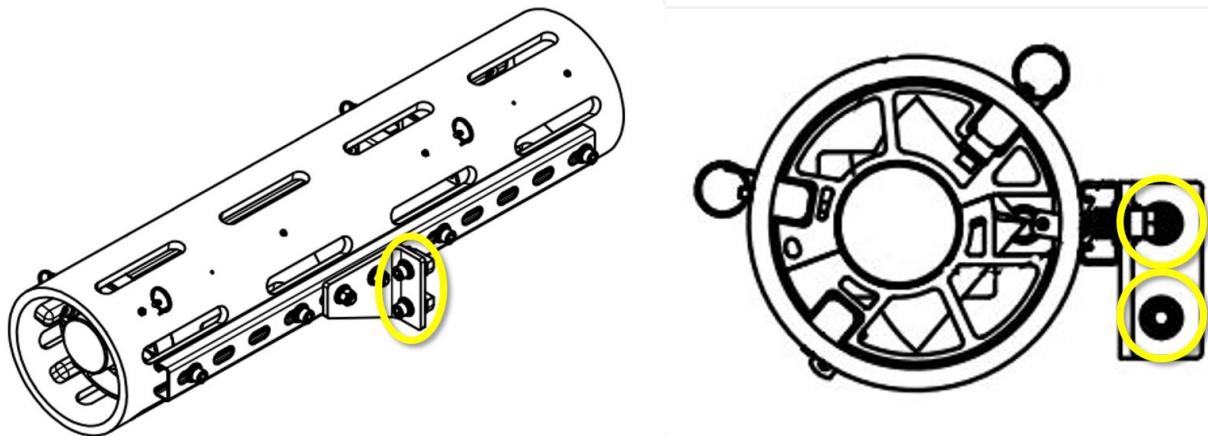

Figure 70. Remove the 2 Bolts that Attach the Mount



Title: NEON Preventive Maintenance Procedure: Submersible Ultraviolet Nitrate Analyzer (SUNA)		Date: 03/22/2022
NEON Doc. #: NEON.DOC.002716	Author: R. Willingham, M. Cavileer, J. Csavina, D. Monahan, B. Hensley	Revision: D

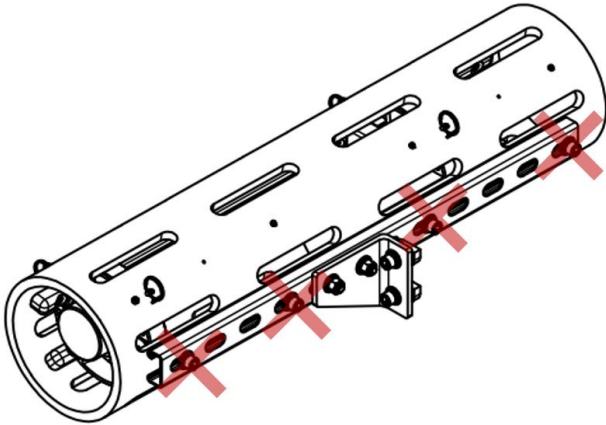

Figure 71. Do Not Remove these 4 Bolts

Do not remove these bolts, unless you want to have a bad time when reinstalling the enclosure (Figure 71).



Figure 72. Remove SUNA PVC Enclosure

STEP 5 | Disconnect the sensor power cable that connects to the Grape (Figure 72).

Remove zip ties that are securing the sensor cable to the anchor, using snips, as appropriate to remove the cable, if necessary, otherwise drape the cable above water to prevent submerging the connectors.

Place a dummy plug over the sensor connector to protect it from getting wet.

STEP 6 | The SUNA enclosure uses two captive discs to hold the sensor in place (Figure 73). If the screws (0337670008) of the captive discs develop significant corrosion, replace the hardware and reassemble the discs following the installation instructions.

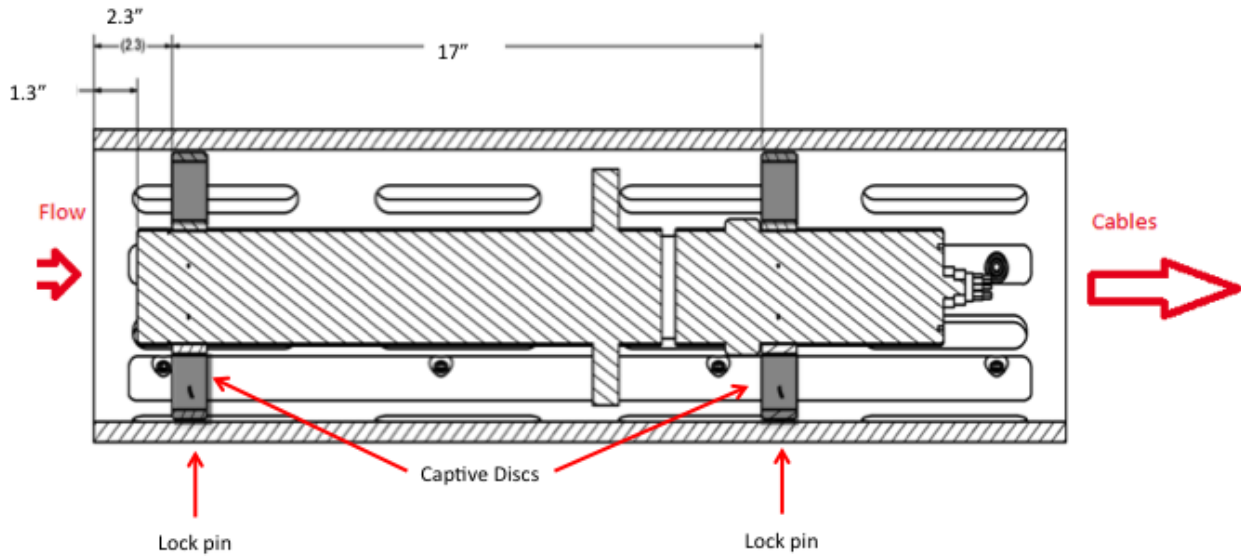

Figure 73. SUNA Orientation and Installation Components

Note: Bio-fouling may accumulate in the tracks, which may cause difficulty removing and reinstalling the SUNA into the PVC enclosure. Try to flush the PVC enclosure with water to dislodge any debris, if possible.



Figure 74. Pull 4 Lock Pins to Remove Captive Discs

STEP 7 | Pull the four lock pins from the enclosure to free the two captive discs (Figure 74).

Note: the pinholes must align with the captive discs. This is good to be aware of for reinstallation of the SUNA in the enclosure.



Title: NEON Preventive Maintenance Procedure: Submersible Ultraviolet Nitrate Analyzer (SUNA)		Date: 03/22/2022
NEON Doc. #: NEON.DOC.002716	Author: R. Willingham, M. Cavileer, J. Csavina, D. Monahan, B. Hensley	Revision: D

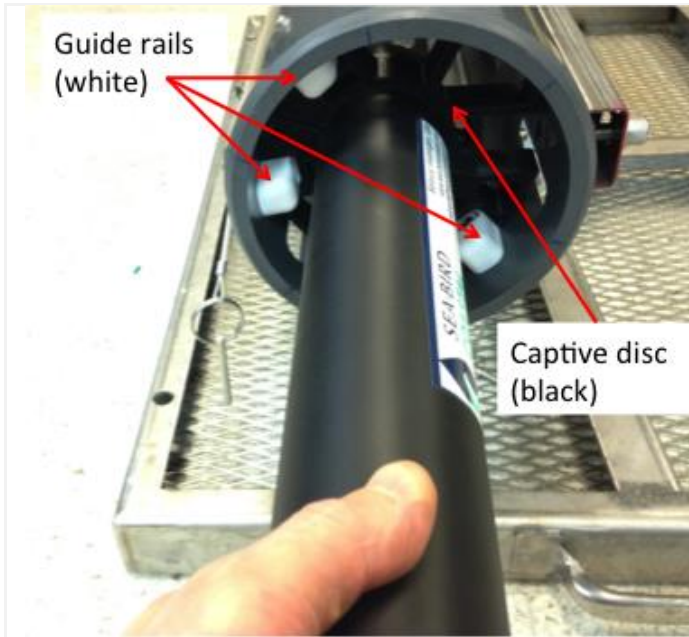

Figure 75. Remove Sensor from PVC Enclosure

STEP 8 | Slide the sensor assembly out of the enclosure by grabbing onto the wiper housing at the top of the sensor (Figure 75). The color of the captive discs may vary, but the design and material are the same across stream sites.

STEP 9 | Install the captive discs on the SUNA, if applicable. These must align with the pinholes on the PVC enclosure. The most common issue that arises when removing/reinstalling the captive discs is when attempting to align the discs with the pinholes in the PVC enclosure. HQ recommends reinstalling the SUNA with captive discs into the enclosure, *out of the water*; it makes it a lot easier to align the discs with tiny pinholes on the PVC when they are not masked under blurry water (Figure 76). Skip this step if personnel did not remove the sensor with captive discs.



Figure 76. S2 SUNA Enclosure at D18 OKSR

Even in clear water (Figure 76), it is difficult to see the pins.

Use a scrub brush and stream water to remove biofouling that may make it difficult to align the pinholes with the captive discs.

STEP 10 | Install the SUNA enclosure on the main vertical support anchor so that it is ± 5 cm above or below the Multisonde probes. The SUNA power cable should exit the enclosure towards downstream. *Reference AD [11] and AD [09] to review stream installation and verification procedures.*

PRO TIP: *slightly thread the nut on the screw first before reinstalling the SUNA enclosure because it is difficult to reach under and place the nut on the screw after enclosure mounts to the anchor.*



STEP 11 | Reinstall a new 12V Merlot Grape into a Grape Shield by threading the four screws that affix the Grape to the Grape Shield using a hex wrench.



Figure 77. Reconnect Sensor Cable and Ethernet Cable to Grape

STEP 12 | Remove dust caps on sensor connectors and Eth-To-Comm connector. Reconnect sensor and armored Ethernet cable in accordance with AD [06].

Use the dust caps from the new Merlot when shipping back the old Merlot for Sensor Refresh.



Figure 78. SUNA Cable Dressing - Complete Installation

STEP 13 | Dress cables with zip ties to look as shown in Figure 78.

Use flush cuts to cut off the remaining zip tie to ensure the cut zip tie is flush. Do not litter the site with leftover zip ties. Ensure these are disposed of properly.

STEP 14 | Restore power to S2 from the Combo Box.



Title: NEON Preventive Maintenance Procedure: Submersible Ultraviolet Nitrate Analyzer (SUNA)		Date: 03/22/2022
NEON Doc. #: NEON.DOC.002716	Author: R. Willingham, M. Cavileer, J. Csavina, D. Monahan, B. Hensley	Revision: D

STEP 15 | Verify the SUNA data streams are present via the Location Controller (LC) and the sensor shows data streaming in one of our in-house remote monitoring tools. If the SUNA is not streaming data, ensure the SUNA CFGLOG is accurate in Maximo.

6.2.2 Lake and River AIS Buoy Sites

For lake and river sites, to include D03 FLNT, reference Section 6 in *AD [07]*, *NEON.DOC.004613 NEON Preventive Maintenance Procedure: AIS Buoy* for removal and replacement procedures. This procedure also includes maintenance on the infrastructure mounting the SUNA (i.e., the Dual PAR SUNA Mount or PVC Fixed Tubes for D03 FLNT).

6.3 Cleaning & Packaging of Returned Sensor

Field Science staff decontaminate, package, and ship sensors back to the CVAL at the NEON Program HQ (Battelle) for annual Sensor Refresh (swap)/calibration requirements. (Please note: if a sensor is defective, submit an incident in the NEON Program’s Issue Reporting and Management System and affix a red tag with the incident number on it (**Figure 80**).

 **Note:** *Asset tags for each sensor must return with the sensor shipment to HQ. Each sensor must reflect CFGLOC changes in the NEON Program Asset Management System. If an asset tag is missing for a sensor, contact the NEON HQ property management office for guidance and awareness for when the shipment arrives at HQ.*

Important: DO NOT tamper with, change or reassign asset tags from Data Generating Device (DGDs) without direct consent from HQ property management office. This prevents chain of custody and/or data issues that tie to asset tags.

6.3.1 Decontamination

Conduct decontamination procedures when shipping the sensor to HQ for annual Sensor Refresh, Winterization or Repair Lab. In addition, per *NEON.AIS.4.1735*, all vehicles, trailers, boats, tools, protective outerwear, and any other items that encounter an aquatic or riparian environment, require decontamination prior to site access. Reference *RD [05]*, *NEON.DOC.004257 NEON Standard Operating Procedure (SOP): Decontamination of Sensors, Field Equipment and Field Vehicles* for instructions to prevent cross-contamination of invasive species and other biological matter from sites.

 **Note:** *Field Science must not transport non-decontaminated sensors in the same shipping and packing materials that are for shipping decontaminated sensors to CVAL. Use a plastic liner to protect the shipping materials from site biologics.*

6.3.2 Storage

Follow the packing procedures in Section 6.3.3 for short-term storage of the sensor, as applicable.



Title: NEON Preventive Maintenance Procedure: Submersible Ultraviolet Nitrate Analyzer (SUNA)		Date: 03/22/2022
NEON Doc. #: NEON.DOC.002716	Author: R. Willingham, M. Cavileer, J. Csavina, D. Monahan, B. Hensley	Revision: D

6.3.3 Packaging

Post-decontamination, follow the procedure below to pack the SUNA to prepare it for shipping and handling.

1. Clean and lubricate the SUNA dummy plug per Section 5.3.4.
2. Attach the dummy plug and twist to secure to sensor.
3. Conduct sensor decontamination per Section 6.3.1.
4. Manually place the wiper in the upward position for shipping.
5. Place the clean, dry sensor into a Pelican case or equivalent for shipping (or storage). **Figure 79** displays the SUNA in a pelican case.



Figure 79. Example of SUNA for Shipping/Storage.

6. Use the manufacturer-provided case for transport (Pelican case). The Domain is responsible for replacing the case if damage or the case is missing. Contact Sea-bird Scientific for ordering information.
7. Label the package as FRAGILE and secure it on the shipping crate or ship separately if SUNA issues require shipment back to HQ other than during the site-specific annual Sensor Refresh.

 **Note:** For any Non-CVAL initiated sensor returns, please notify CVAL of the return via the project's issue management system.



Title: NEON Preventive Maintenance Procedure: Submersible Ultraviolet Nitrate Analyzer (SUNA)		Date: 03/22/2022
NEON Doc. #: NEON.DOC.002716	Author: R. Willingham, M. Cavileer, J. Csavina, D. Monahan, B. Hensley	Revision: D

Complete an External Transfer Request (ETR), Bill of Lading and Site Manifest pack list per in accordance with RD [08] or via the Issue Management System and return to the NEON Program HQ using the following address:

BATTELLE ECOLOGY, **ATTN: CVAL**
 1685 38TH STREET, SUITE 100
 BOULDER, CO 80301

Only include sensors/subsystems for Sensor Refresh. Additional equipment must ship separately as they may require attention from other NEON HQ departments. Sensor refresh shipments go direct to CVAL. If sensors are shipping to HQ to address a trouble ticket, per guidance via the Issue Management System, return to the NEON Program HQ using the following address with an ETR and a red defective tag:

BATTELLE ECOLOGY, **ATTN: REPAIR LAB**
 1685 38TH STREET, SUITE 100
 BOULDER, CO 80301

6.4 Sensor Refresh Record Management of Assets

In addition to the physical movement of devices, the sensor refresh process requires dedicated and accurate record management of asset movement and location. **Reference RD [08] for the standard operating procedures for the annual Sensor Refresh process and delineation of sensor, administrative and logistical requirements.**

6.4.1 NEON Asset Management and Logistic Tracking System Requirements

Field Science must update the instrumentation records via the NEON’s project Asset Management and Logistic Tracking System (MAXIMO). NEON HQ must maintain accurate record keeping on the location, date, and time offline of an instrument to ensure NEON HQ, Computer Infrastructure, Data Products, and CVAL are aware to apply the correct algorithms, calibrations, and processing factors. Reference RD [08] for additional information on Sensor Refresh administrative procedures. Ensure the CFG location reflects the current site of the sensor. All devices leaving a CFGLOC must move to SITE first, then TRANSIT/DxxSUPPORT.

 **Note: In general, to minimize errors for CI, all devices leaving a CFGLOC must move to SITE first, then TRANSIT/DxxSUPPORT.**

 **Note: An important exception when assigning CFG locations are Grape data loggers. Grapes remain at the SITE level (a four-letter site code) or a more specific location within the hierarchy. Do not assign**



Title: NEON Preventive Maintenance Procedure: Submersible Ultraviolet Nitrate Analyzer (SUNA)		Date: 03/22/2022
NEON Doc. #: NEON.DOC.002716	Author: R. Willingham, M. Cavileer, J. Csavina, D. Monahan, B. Hensley	Revision: D

Grapes to a CFG location using the “CFGLOC” prefix. Grapes are data loggers and log data from sensors from specific CFG locations.

After installation of the sensors, verify sensor data state of health (Data Product) in PuTTY, DQBlizzard and/or the IS Monitoring and Control Suite the next day. Validate sensor data stream(s) and LO data is within an expected range for your site. Monitor the sensor frequently after maintenance activities to ensure it continues to function as expected through remote monitoring.

6.4.2 Remote Connection Program Information Requirements

For AIS Buoy sites, if there is a need to access LoggerNet™ (Profiler and MET Software) remotely (from the Domain or HQ), ENG must shut down the RTU program for the site (software that collects and transmits the data from the AIS Buoy to HQ). The RTU program uses the same port we would use to connect remotely to communicate with LoggerNet™. Generate a request via the NEON Issue Management/Reporting System to coordinate to contact the Software Engineers in the NEON HQ, Engineering Department. Otherwise, verify the Buoy sensor data from the Oz Grape using PuTTY (note the data streams are collected in bursts via radio transmission).



Title: NEON Preventive Maintenance Procedure: Submersible Ultraviolet Nitrate Analyzer (SUNA)		Date: 03/22/2022
NEON Doc. #: NEON.DOC.002716	Author: R. Willingham, M. Cavileer, J. Csavina, D. Monahan, B. Hensley	Revision: D

7 ISSUE REPORTING OUTPUTS

Use this metadata sheet in Table 16. SUNA Issue Reporting Datasheet to track and/or communicate maintenance tasks and findings by technician/site/date. Follow local paper-based and electronic record management procedures.

Table 16. SUNA Issue Reporting Datasheet.

Issue Reporting Datasheet		
Datasheet field	Entry	
Domain and Aquatic Site Code		
Maintenance Time and Date		
Maintenance Technician		
Preventive Maintenance	Issue Noted	Issue Summary
Cables & Connectors - Condition Check	<input type="checkbox"/>	
SUNA Grape – Condition Check	<input type="checkbox"/>	
SUNA Mount – Condition Check	<input type="checkbox"/>	
SUNA External Surface – Condition Check	<input type="checkbox"/>	
SUNA Window – Condition Check	<input type="checkbox"/>	
SUNA Optical Path – Condition Check	<input type="checkbox"/>	
SUNA Validation – Drift Test	<input type="checkbox"/>	
SUNA Validation – Configuration Check	<input type="checkbox"/>	
SUNA Available Lamp Time Check	<input type="checkbox"/>	Available lamp time:
SUNA Self Test Check	<input type="checkbox"/>	Spec Lght av:
SUNA Validation – Reference Check	<input type="checkbox"/>	
SUNA Calibration – Reference Spectrum	<input type="checkbox"/>	
Sensor - Other Specific Checks (<i>Sensor and cable ties are secure, no corrosion is occurring on the captive discs, etc.</i>)	<input type="checkbox"/>	
Environmental Information (<i>Any significant weather events occur that may correlate with the issue summary?</i>)	<input type="checkbox"/>	
Sensor Removal (<i>due to seasonal conditions such as significant freezing, ice heaving and accumulations, etc.</i>)	<input type="checkbox"/>	
Notes		

For SUNA corrective actions, ensure proper tracking of the asset via the NEON Issue Management and Tracking System (i.e., ServiceNow) to establish a chain of custody of the asset between Engineering Manufacturing and CVAL.

Conduct the following tasks to ensure the proper management of the asset between sites:



Title: NEON Preventive Maintenance Procedure: Submersible Ultraviolet Nitrate Analyzer (SUNA)		Date: 03/22/2022
NEON Doc. #: NEON.DOC.002716	Author: R. Willingham, M. Cavileer, J. Csavina, D. Monahan, B. Hensley	Revision: D

1. For each issue where NEON, HQ is replacing a defective instrument/subsystem at an AIS site, create an incident and assign incident tasks to HQ personnel in the NEON Issue Management and Reporting System for the defective asset from the reported issue.
2. Ship all defective equipment/assets with a red "Rejected" tag. **Figure 80** displays the minimum information requirements for each tag.

REJECTED

CUSTOMER _____

JOB # **Incident Task Number (INC#####)** DATE _____

P.O. # **ASSET TAG NUMBER** _____

PART _____

PART # _____ SERIAL # _____

PCS. REJECTED _____

REASON **Incident Task Title** _____

INSPECTED BY _____

Figure 80. Red Rejected Tag for Defective Assets (MX104219).



Title: NEON Preventive Maintenance Procedure: Submersible Ultraviolet Nitrate Analyzer (SUNA)		Date: 03/22/2022
NEON Doc. #: NEON.DOC.002716	Author: R. Willingham, M. Cavileer, J. Csavina, D. Monahan, B. Hensley	Revision: D

8 APPENDIX A: PREVENTATIVE MAINTENANCE QUALITY ASSURANCE DATASHEET

Table 17 provides the minimum standard for information Field Science must capture either electronically or via paper-based methods when conducting preventive maintenance on this sensor. Follow local paper-based and electronic record management procedures.

Table 17. Preventative Maintenance Quality Assurance Datasheet.

Preventative Maintenance Quality Assurance Datasheet			
Datasheet field		Entry	
Site Code			
Maintenance Date			
Maintenance Technician			
Quality Assurance Data	Pre-Cleaning Value	Post-Cleaning/Pre-Calibration Value	Post-Calibration Value
Nitrate			
Available Lamp Time (hours)			
Notes			



Title: NEON Preventive Maintenance Procedure: Submersible Ultraviolet Nitrate Analyzer (SUNA)		Date: 03/22/2022
NEON Doc. #: NEON.DOC.002716	Author: R. Willingham, M. Cavileer, J. Csavina, D. Monahan, B. Hensley	Revision: D

9 APPENDIX B: REMOTE CONNECTION & BASIC TROUBLESHOOTING

The following procedures build upon the procedures in AD [09] and information in AD [04]. These are useful for connecting to the sensor remotely and to perform remote troubleshooting. This section covers the most common failure modes from SUNAs to date. Use **Table 18** to identify the following issues:

- Incorrect Configuration Settings: This is usually from leaving the SUNA in continuous mode.
- Improper SUNA Disconnects: This occurs from physically disconnecting from the SUNA before disconnecting the SUNA from the UCI software.
- Subsystem Grape Time-out: Wait 5 minutes before restoring power to the SUNA Merlot Grape after Field Validations. This allows the SUNA and Grape to reinitialize together; failure to reset the Grape’s communication protocol prevents the SUNA data from streaming to the LC.

Table 18. How to Connect to the SUNA with Putty.

Step #	Instructions
1	Physically connect to the SUNA with the calibration Y-cable. This cable also powers the SUNA during this process.
2	Open PuTTY (or other SSH client) and select “ Serial ” for the Connection Type.
3	Type in the active COM Port as “ COM# ” in the Serial line. (Look at Settings > Devices > Connected Devices to get the COM Port number of the SUNA.) Type the baud rate “ 57600 ” in the Speed line for a stream SUNA or “ 115200 ” for a buoy SUNA (Figure 81).

The screenshot shows the PuTTY Configuration dialog box. On the left is a tree view with categories: Session, Terminal, Window, and Connection. The 'Connection' category is expanded, showing options for Data, Proxy, Telnet, Rlogin, SSH, and Serial. The 'Serial' option is selected. On the right, under 'Basic options for your PuTTY session', the 'Serial line' field contains 'COM7' and the 'Speed' field contains '115200'. Below this, the 'Connection type' section has radio buttons for Raw, Telnet, Rlogin, SSH, and Serial, with 'Serial' selected. At the bottom, the 'Close window on exit' section has radio buttons for Always, Never, and Only on clean exit, with 'Only on clean exit' selected. Buttons for 'Open' and 'Cancel' are at the bottom right.



Title: NEON Preventive Maintenance Procedure: Submersible Ultraviolet Nitrate Analyzer (SUNA)		Date: 03/22/2022
NEON Doc. #: NEON.DOC.002716	Author: R. Willingham, M. Cavileer, J. Csavina, D. Monahan, B. Hensley	Revision: D

Step #	Instructions
Figure 81. Connect to SUNA via Putty Serial Connection	
4	<p>Click “Open” in the bottom right window in Figure 81.</p> <p>⚠ Warning: Typing characters into the open terminal window triggers or “wakes” the SUNA, and removes it from run mode. <u>After typing characters into the terminal window, you must follow this procedure to completion to return the SUNA to operational mode.</u></p> <p>If you type nothing into the open terminal window, and you followed Section 5.5, the SUNA will transmit data into this window. This is useful for troubleshooting hardware if the SUNA is not streaming to the LC.</p>
5	<p>Type “\$” and press enter in the terminal window.</p> <p>Output from the SUNA should appear. Either the prompt “SUNA>” or the following:</p> <pre>[2017/08/16 17:02:42] vMainNitrateTask()::INFO-Start SUNA SN:0838 V2, FW 2.5.1 [2017/08/16 17:02:42] vMainNitrateTask()::INFO-Charge power loss protector. [2017/08/16 17:02:44] vMainNitrateTask()::INFO-Reset from power cycling, sv telemetry wakeup</pre> <p>Continue pressing combinations of “\$” and “<enter>” until the “SUNA>” prompt appears in the terminal window.</p> <p>i Note: If garbage characters appear, the baud rate programmed into the SUNA is likely incorrect or the SUNA calibration cable is bad. Try reconnecting the cable or use the other baud rate until successful. (SUNAs coming from CVAL may have either baud rate randomly.)</p>
6	Once the “SUNA>” prompt appears, type “get cfg” and press enter.
7	Compare this list of parameters in accordance with AD [04] to verify they are correct.
8	If a parameter is incorrect, use the command “set PARAMETER VALUE” and press enter. If successful, “\$Ok” is returned before the next “SUNA>” prompt. Ensure CVAL is aware of any changes to the configuration outside of field calibration/reference spectrum updates. Capture the “get cfg” before and after the changes and submit them to CVAL via ServiceNow.
9	Repeat Steps 7 and 8 until all SUNA configuration parameters are correct.
10	<p>Type “exit” and press enter. The “SUNA>” prompt should disappear and the following output may also appear:</p> <pre>SUNA> exit \$Ok SUNA> [2017/08/16 17:05:34] mode_Periodic()::INFO-Down until 2017/08/16 17:15:00 [2017/08/16 17:05:36] vPLSTask()::INFO-Power is off, shutting down.</pre> <p>⚠ Warning: Without the proper “exit” command, the SUNA will be waiting at the “SUNA>” prompt and will never run or send data. If the SUNA was disconnected without exiting properly, reconnect and type “\$” and <enter> combinations until the “SUNA>” prompt appears and then type exit. If in doubt, repeat this procedure until you are confident the SUNA is properly disconnected.</p>
11	Post-reinstallation, verify the SUNA is streaming to the LC.



Title: NEON Preventive Maintenance Procedure: Submersible Ultraviolet Nitrate Analyzer (SUNA)		Date: 03/22/2022
NEON Doc. #: NEON.DOC.002716	Author: R. Willingham, M. Cavileer, J. Csavina, D. Monahan, B. Hensley	Revision: D

If the SUNA is not streaming to the LC after performing the procedure in **Table 18**, connect to the SUNA through the LC using **Table 19**. Verifying SUNA Configuration Settings Remotely. If this procedure is unsuccessful, there is a communication issue between the SUNA and LC. This issue is the result of any of the following issues. Submit an incident in ServiceNow, if you are unable resolve the issue.

- Damaged SUNA Power Cable (Field troubleshooting options are limited. If possible, use a DMM to pin-out the cable for continuity using the cable drawing in APPENDIX C: SUNA POWER CABLE or generate a request in ServiceNow for a replacement.)
- Defective or Timed-out Grape (If “**nc localhost 30200**” does not list a “**GRAPE-SUNA**” in the output, power-cycle the SUNA’s Grape for 10-15 minutes. If Grape is not streaming at all with “**vd | grep MAC**”, create an incident in ServiceNow for further troubleshooting instructions.)
- Connector/Connection Damage between SUNA and LC (Inspect and reset all connections between the SUNA and LC, inspect cables along full length for damage/kinking.)

Table 19. Verifying SUNA Configuration Settings Remotely.

Step #	Instructions
1	Log onto LC.
2	Execute “ nc localhost 30200 ”.
3	Find the line that says “ Grape-SUNA ” and note the IP address.
4	Type “ telnet -8 IPADDRESS ” and press enter.
5	When the prompt says “ Grape> ” type “ connect a ” and press enter.
6	On the next blank line start pressing “ \$\$\$\$ ” and “ enter ”. Sometimes a combination of both works best.
7	Eventually the prompt will say “ SUNA> ”, which indicates successful connection to the SUNA.
8	Type “ get cfg ” and press enter.
9	Compare this list of parameters to AD [4], checking that each parameter is correct.
10	If a parameter is incorrect, submit an incident ticket in the NEON Program’s Issue Reporting and Management System. Use the command “ set PARAMETER VALUE ” and press enter. If successful, “ \$Ok ” is returned before the next “ SUNA> ” prompt after receiving guidance/permission/oversight from HQ. Incorrect configuration parameters throws the sensor out of calibration. Ensure CVAL is aware of any changes to the configuration outside of field calibration/reference spectrum updates. Capture the “ get cfg ” before and after the changes and submit them to CVAL via ServiceNow.
11	If granted permission/under direction of CVAL, configure the sensor until all parameters are correct.
12	Type “ exit ” and press enter. Then Type “ CTRL-J ” to exit the telnet, and finally type “ quit ” to kill the telnet connection. ⚠ Warning: Without the proper “exit” command, the SUNA will be waiting at the “SUNA>” prompt and will never run or send data. If the SUNA was disconnected without exiting properly, reconnect and type “ \$ ” and enter combinations again until the “SUNA>” prompt appears and then type exit.
13	Check for SUNA data streams on the LC.



Title: NEON Preventive Maintenance Procedure: Submersible Ultraviolet Nitrate Analyzer (SUNA)		Date: 03/22/2022
NEON Doc. #: NEON.DOC.002716	Author: R. Willingham, M. Cavileer, J. Csavina, D. Monahan, B. Hensley	Revision: D

10 APPENDIX C: SUNA POWER CABLE ASSEMBLY DRAWING

The SUNA power cable (**Figure 82**) and wiring (**Figure 83**) are for reference purposes.

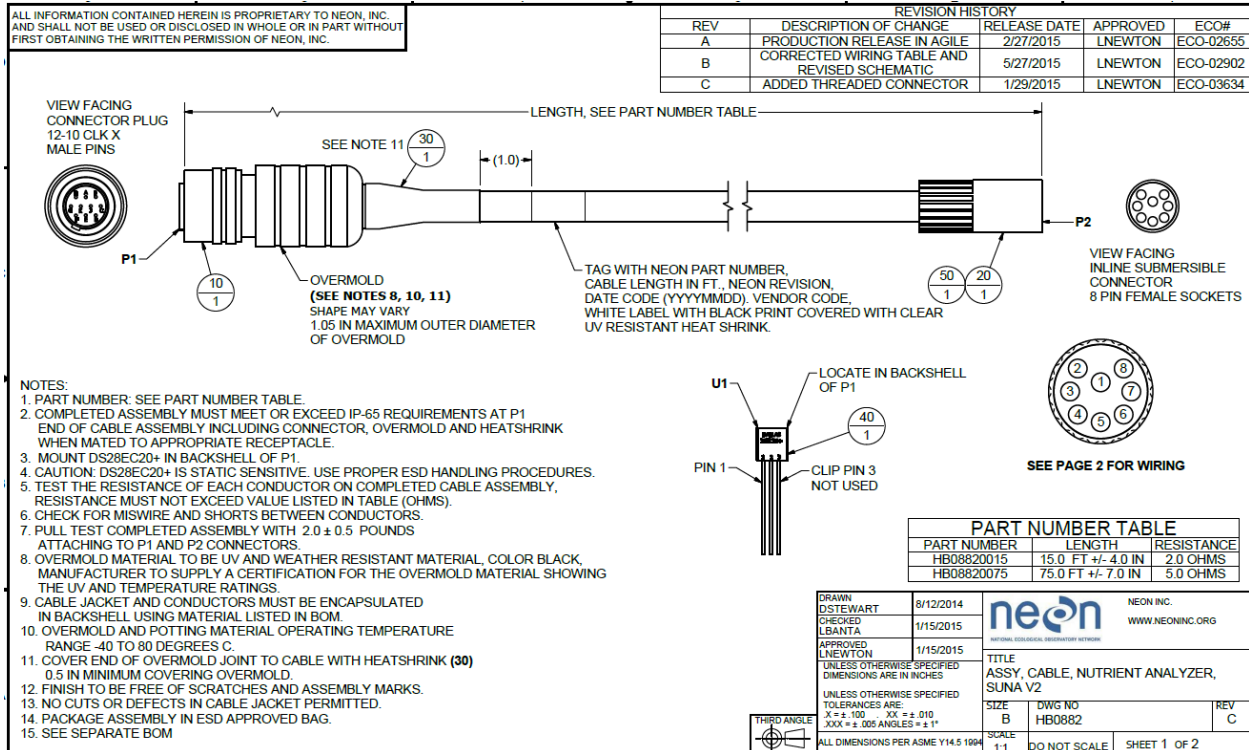

Figure 82. SUNA Power Cable Drawing.

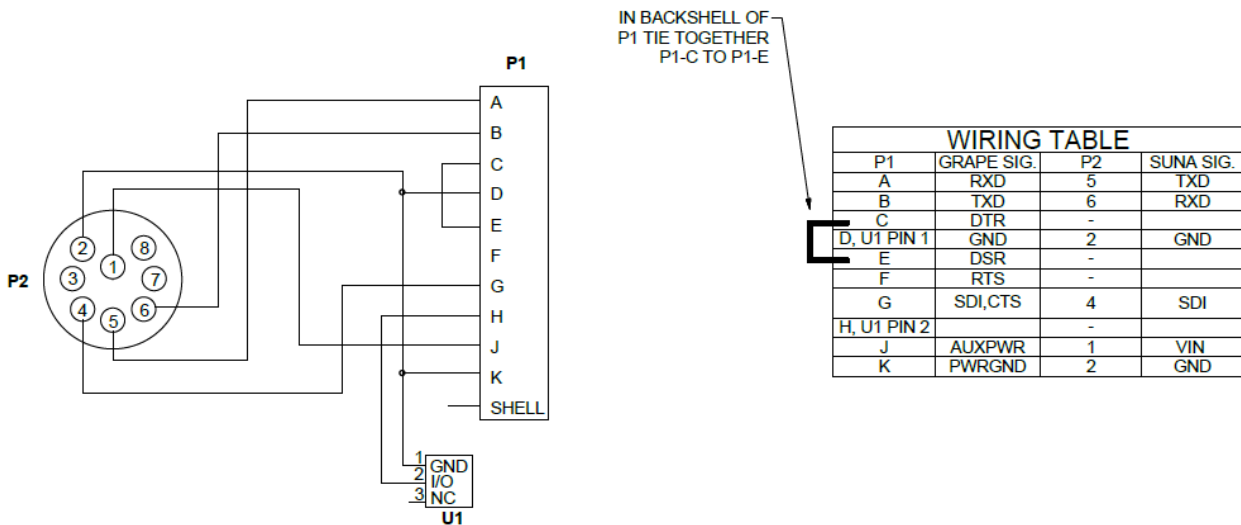

Figure 83. SUNA Power Cable Wiring.



Title: NEON Preventive Maintenance Procedure: Submersible Ultraviolet Nitrate Analyzer (SUNA)		Date: 03/22/2022
NEON Doc. #: NEON.DOC.002716	Author: R. Willingham, M. Cavileer, J. Csavina, D. Monahan, B. Hensley	Revision: D

11 APPENDIX D: MONITORING SUNA DATA FOR PROBLEMS

Use the DQ Blizzard tool to view L0 SUNA data. Select the start and end date-time for the period you wish to view (Note, DQ Blizzard updates at the end of each day, so today's data is not available to view). Select the domain and site. Under "ID" select **20033 – Nitrate in surface water**. Check that the **HOR.VER** is the correct location for the SUNA onsite. Select the box that says "Extract L0 sub-stream for plot?". This allows you to choose the "Stream Number" you wish to view. Most often, stream number **004 – Nitrate concentration** is what you will want to view, but other streams, such as temperature, humidity or voltage are useful in diagnosing problems. Select "Plot data?" And then hit "Go!".

Below are common examples of "good data" and "bad data". Note, these are cherry-picked examples, in practice, the distinctions may not be as clear. When in doubt, contact the AQU Science Team for guidance.

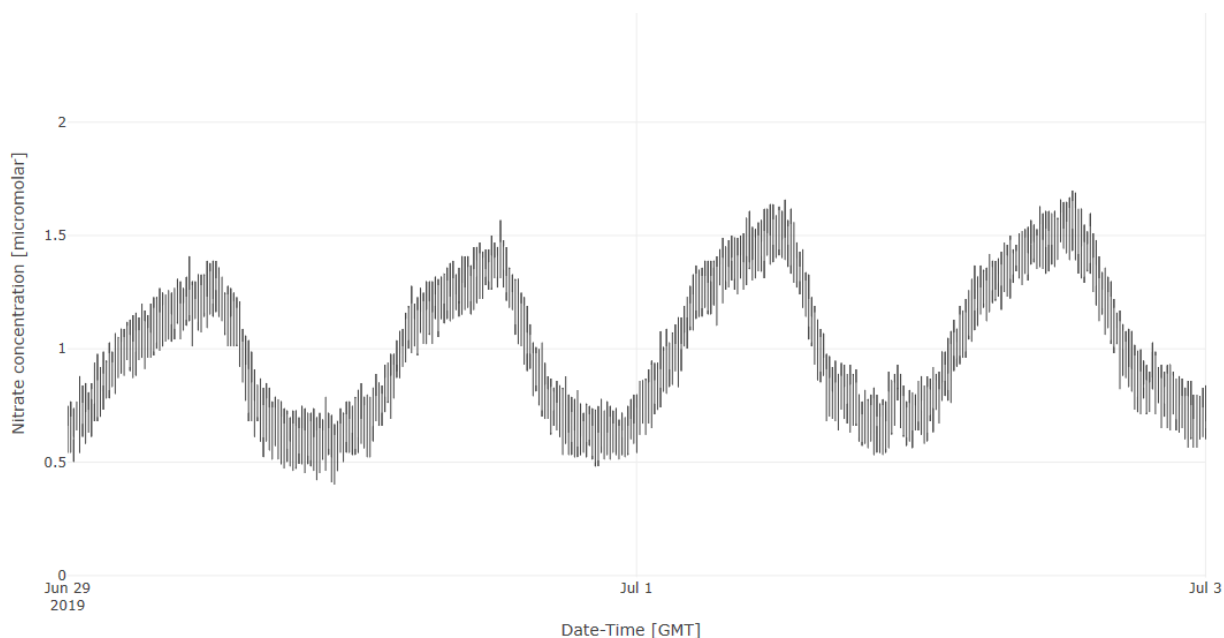

Figure 84. This is an example of what good SUNA data looks like. Each line represents a 15 burst. Check that there are data every 15 minutes. Note the low variance within burst and low variance from one burst to the next. You can view individual values by zooming in and hovering the cursor over them. This site shows diel variation in nitrate produced by processes such as plants assimilating nitrate and microbes performing denitrification. Diel variation is a common (but not ubiquitous) feature of aquatic nitrate signals.



Title: NEON Preventive Maintenance Procedure: Submersible Ultraviolet Nitrate Analyzer (SUNA)		Date: 03/22/2022
NEON Doc. #: NEON.DOC.002716	Author: R. Willingham, M. Cavileer, J. Csavina, D. Monahan, B. Hensley	Revision: D

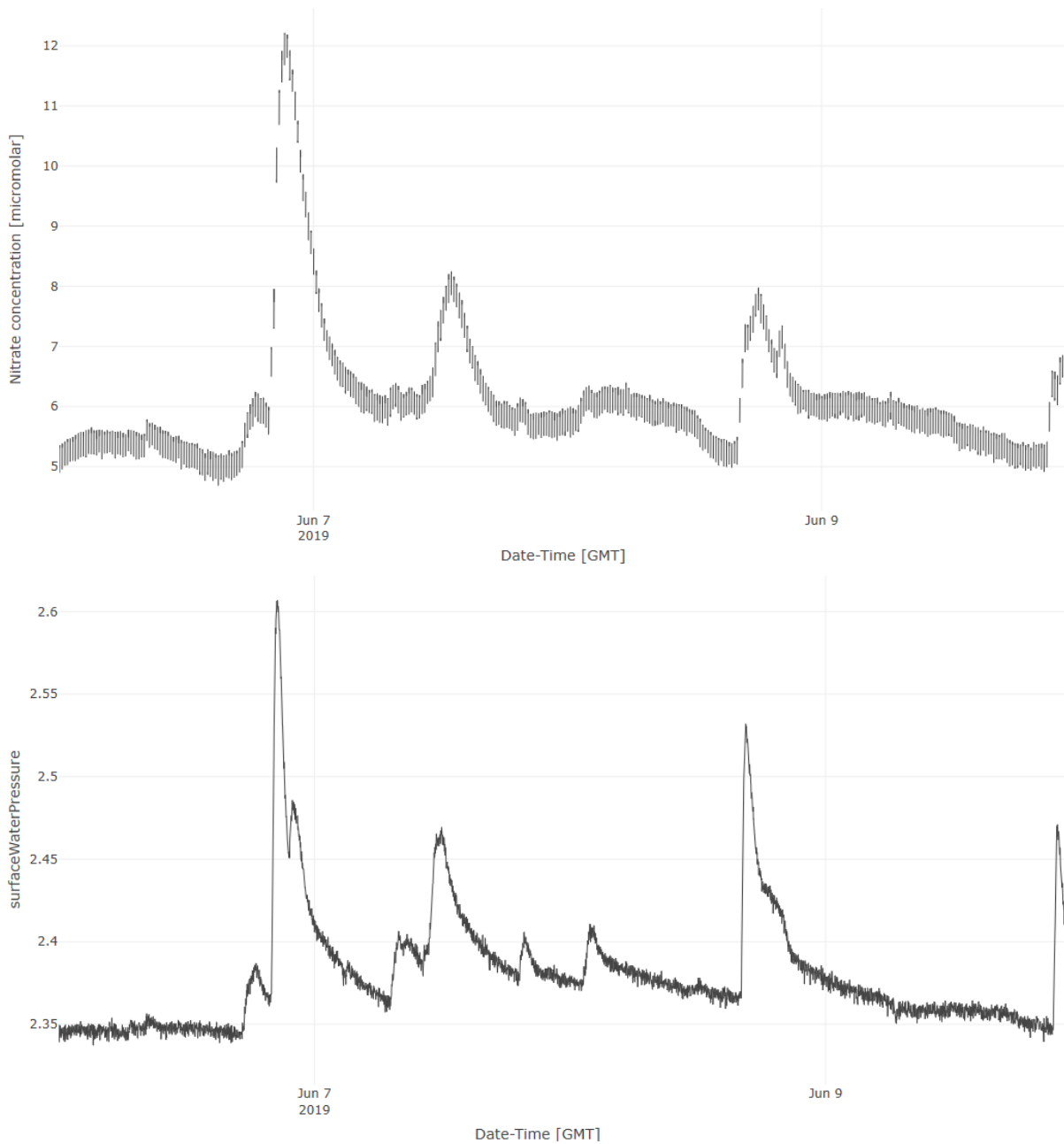

Figure 85. This is an example shows large and rapid spikes in nitrate concentration. However, if we also look at the water surface pressure data on Blizzard, we can see that there were contemporaneous increases in water depth, suggesting storm events occurred. Storm events can enrich or dilute nitrate concentrations, producing sudden peaks or troughs. This is normal. However, sudden and large nitrate peaks without a change in water level or other chemical parameters (check the Multisonde data) it can be cause for concern. If you see unusual behavior in the nitrate data, check and see if it also occurs in other data streams, which might indicate it is natural variation.

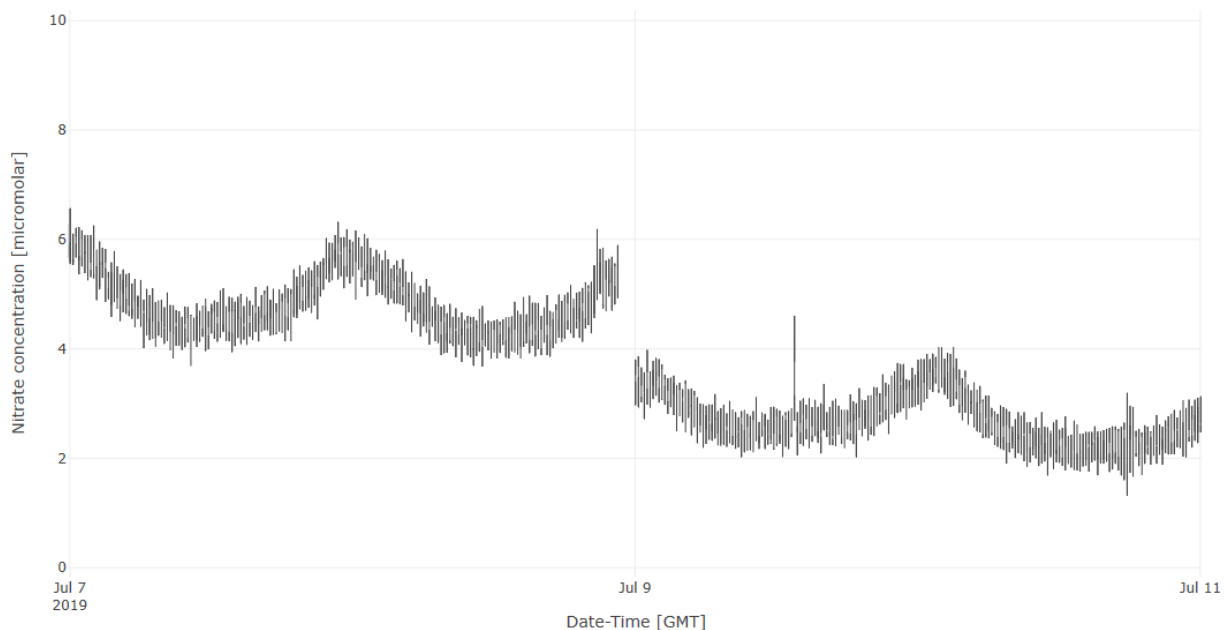

Figure 86. This is an example of how PM such as cleaning or calibration can affect the nitrate concentration. Biofouling on the lens or reduction in lamp output causes less light to reach the SUNA detector. The SUNA assumes this is happening because more light is being absorbed by nitrate, and so it predicts a higher concentration. Cleaning and reference updates will usually cause the concentration to drop. The change in the concentration measured in water should be comparable in magnitude to the change measured in DI as part of the PM.

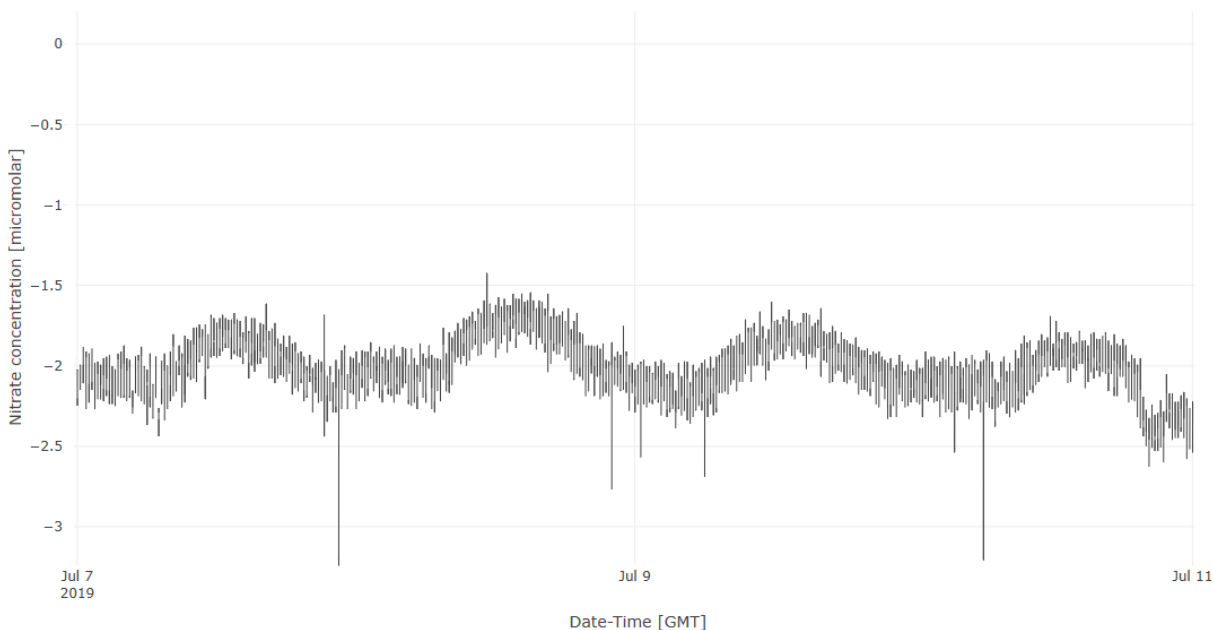

Figure 87. This example shows data with low variance and diel variation, but the concentrations are negative. The reference spectrum may have been calibrated incorrectly (the lens was not clean or DI was contaminated). Re-perform the update. If the problem persists the SUNA needs to be serviced.



Title: NEON Preventive Maintenance Procedure: Submersible Ultraviolet Nitrate Analyzer (SUNA)		Date: 03/22/2022
NEON Doc. #: NEON.DOC.002716	Author: R. Willingham, M. Cavileer, J. Csavina, D. Monahan, B. Hensley	Revision: D

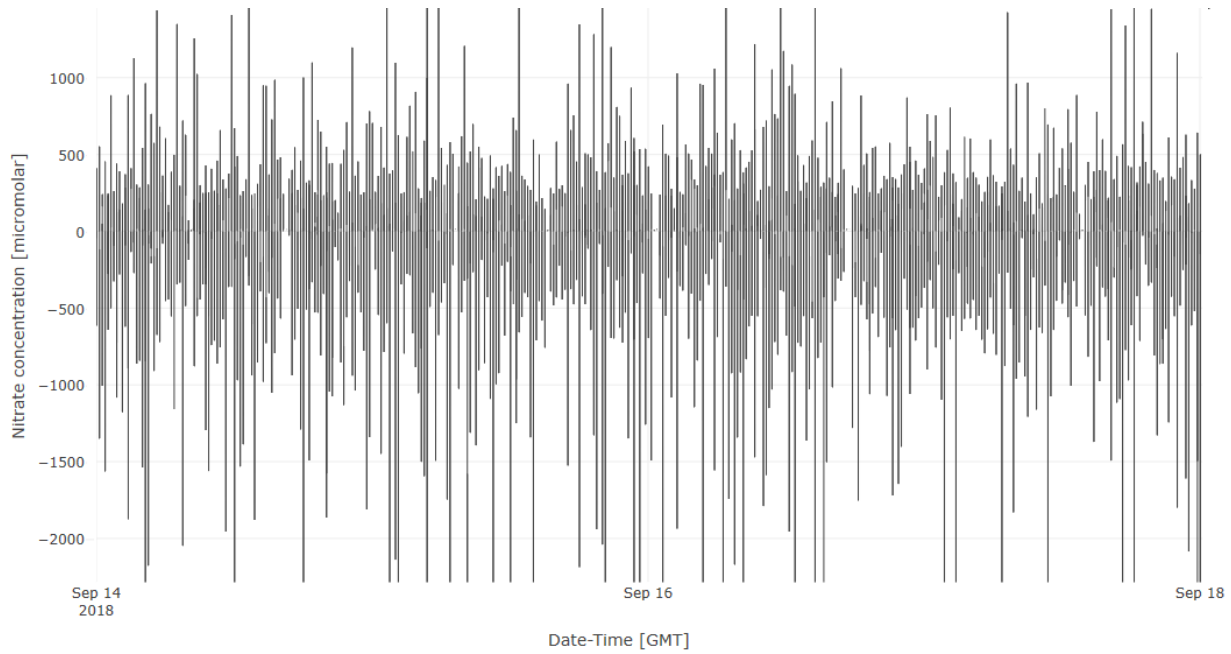

Figure 88. This example shows data with large variance both within and across bursts. The sensor is potentially fouled or the lamp has degraded. Check that the sensor is not buried, clean the optical lens, perform a reference spectrum update and then a self-test to measure the lamp output.

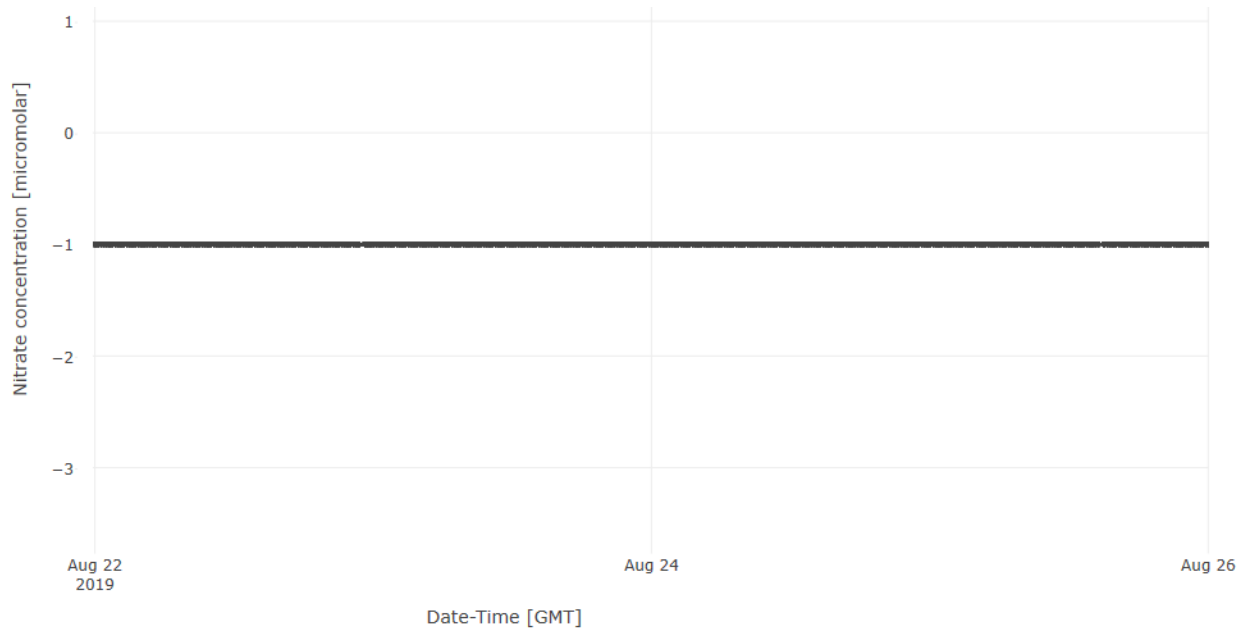

Figure 89. This example shows a string of all “-1”. This is not a real concentration, but an error code the SUNA uses to report low transmittance. Report to Aquatic Science Team.



Title: NEON Preventive Maintenance Procedure: Submersible Ultraviolet Nitrate Analyzer (SUNA)		Date: 03/22/2022
NEON Doc. #: NEON.DOC.002716	Author: R. Willingham, M. Cavileer, J. Csavina, D. Monahan, B. Hensley	Revision: D

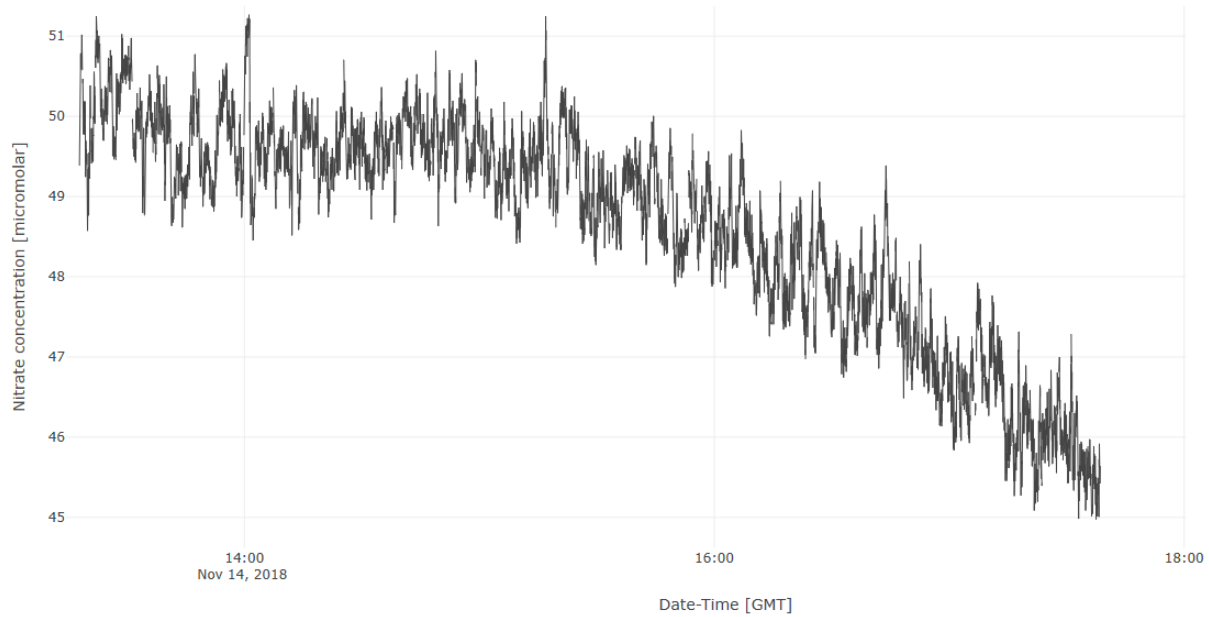

Figure 90. This example shows continuous data rather than 15 minute bursts. The SUNA was accidentally left in Continuous mode following PM. Reconnect to the SUNA and correct the settings to Periodic.

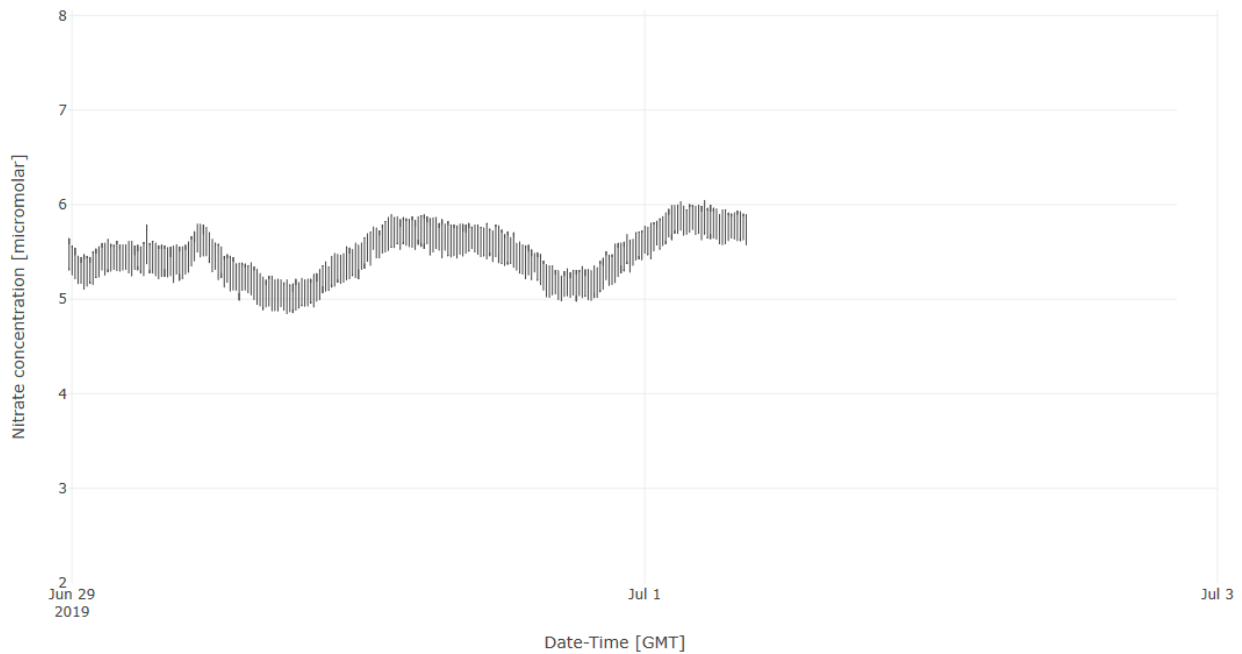

Figure 91. This example shows the SUNA was transmitting quality data until a PM occurred, at which point it stopped streaming. Check that UCI was exited out of correctly (5.5 Step 2), re-open and disconnected correctly if needed. Check that the SUNA cable was reconnected to the Grape data logger. Check that the SUNA was acquired by the Grape (5.5 Step 5); power cycle the Grape, if necessary.



Title: NEON Preventive Maintenance Procedure: Submersible Ultraviolet Nitrate Analyzer (SUNA)		Date: 03/22/2022
NEON Doc. #: NEON.DOC.002716	Author: R. Willingham, M. Cavileer, J. Csavina, D. Monahan, B. Hensley	Revision: D

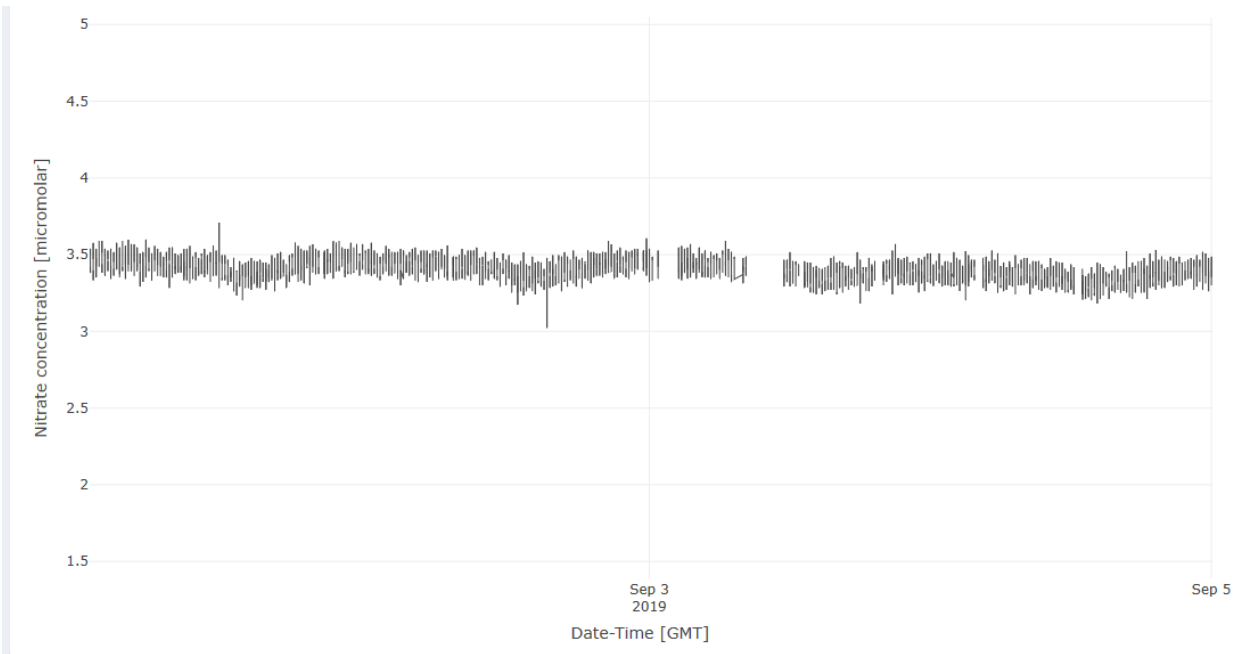

Figure 90. This example shows otherwise good data with gaps in it. This is usually a communication issue, not a sensor issue. Check the connection between the SUNA and the Grape data logger. For buoy sites, check the radio link. This particular example occurred for a buoy whose moorings were lose allowing wind to rotate the SUNA antenna out of line of sight with the shore receiver.



12 APPENDIX E: RETRIEVING PAST CALIBRATION FILES

This appendix provides guidance on how to retrieve previous calibration files. **Figure 84** is the process to manually download the calibration file from the SUNA, if it cannot be found on the computer.

Important: Do not delete or change the active calibration file (highlighted in green in **Figure 84**).

1. Connect to the SUNA with UCI (reference Section 5.4.2).
2. Click "Transfer Files".
3. Click the "Calibration Files" tab.
4. Change the local destination directory, if desired.
5. Select the calibration file.
6. Select the "<" to copy the selected file to the local destination directory.

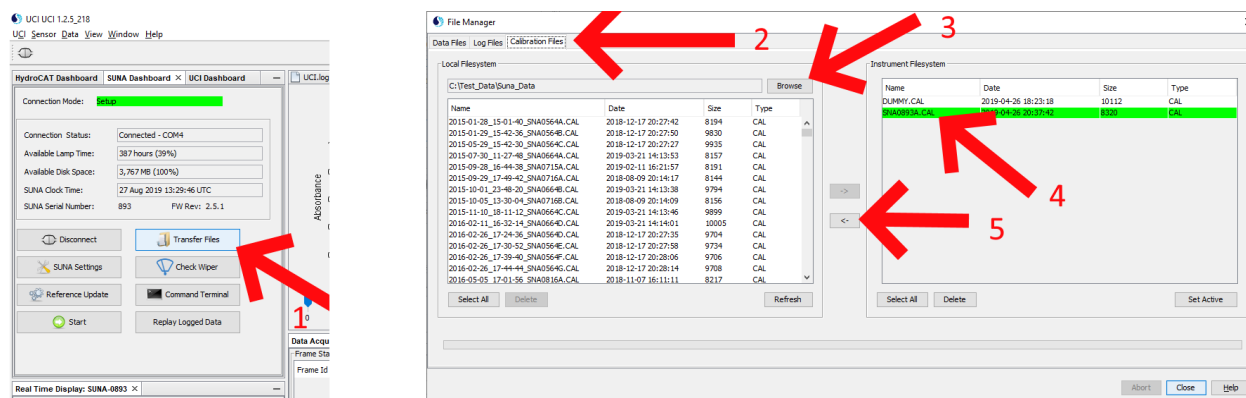

Figure 84. Process to Manually Download SUNA Calibration Files.

Figure 85 is the default file location setup in UCI and the typical folder to find cal files for CVAL.

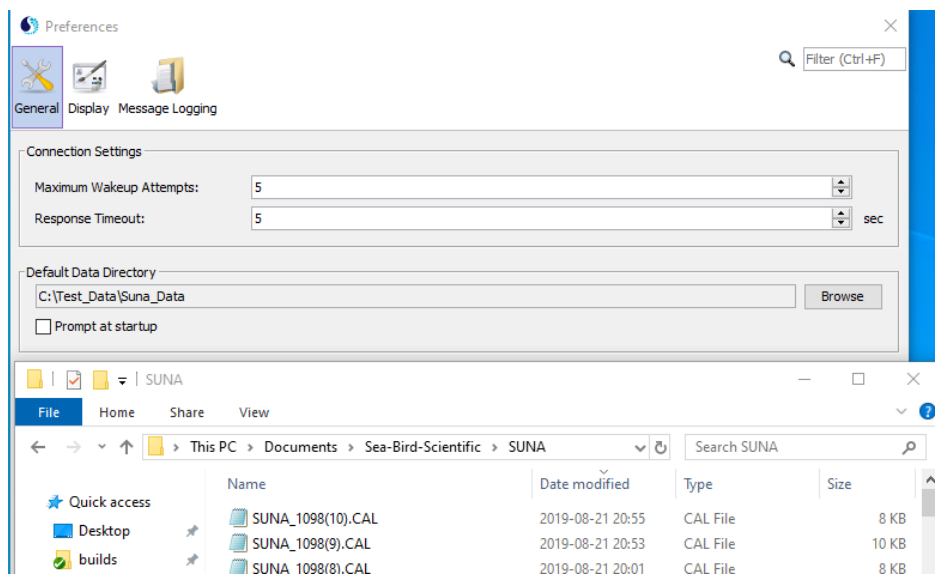

Figure 85. Default File Location Setup in UCI.



neon
Operated by Battelle

<i>Title:</i> NEON Preventive Maintenance Procedure: Submersible Ultraviolet Nitrate Analyzer (SUNA)		<i>Date:</i> 03/22/2022
<i>NEON Doc. #:</i> NEON.DOC.002716	<i>Author:</i> R. Willingham, M. Cavileer, J. Csavina, D. Monahan, B. Hensley	<i>Revision:</i> D

13 SOURCES

ASTM D1193-99e1, Standard Specification for Reagent Water, ASTM International, West Conshohocken, PA, 1999, www.astm.org

INC0031743 D16: MART - SUNA Calibration Files not downloading to computer 09/23/2019