

<i>Title:</i> NEON Preventive Maintenance Procedure: Underwater Photosynthetically Active Radiation (UPAR)		<i>Date:</i> 2/12/2018
<i>NEON Doc. #:</i> NEON.DOC.002757	<i>Author:</i> D. Monahan, M. Cavileer, G. Simonds	<i>Revision:</i> A

NEON PREVENTIVE MAINTENANCE PROCEDURE: UNDERWATER PHOTOSYNTHETICALLY ACTIVE RADIATION (UPAR)

PREPARED BY	ORGANIZATION	DATE
Dylan Monahan	SCI	12/11/2017
Geoff Simonds	SE	01/10/2018
Madeline Cavileer	ENG	01/11/2018

APPROVALS	ORGANIZATION	APPROVAL DATE
Laura Leyba-Newton	ENG	2/06/2018
Mike Stewart	PSE	2/02/2018

RELEASED BY	ORGANIZATION	RELEASE DATE
Anne Balsley	CM	02/12/2018

See configuration management system for approval history.

The National Ecological Observatory Network is a project solely funded by the National Science Foundation and managed under cooperative agreement by Battelle. Any opinions, findings, and conclusions or recommendations expressed in this material are those of the author(s) and do not necessarily reflect the views of the National Science Foundation.

<i>Title:</i> NEON Preventive Maintenance Procedure: Underwater Photosynthetically Active Radiation (UPAR)		<i>Date:</i> 2/12/2018
<i>NEON Doc. #:</i> NEON.DOC.002757	<i>Author:</i> D. Monahan, M. Cavileer, G. Simonds	<i>Revision:</i> A

Change Record

REVISION	DATE	ECO #	DESCRIPTION OF CHANGE
A	2/12/2018	ECO-05385	Initial release.

Title: NEON Preventive Maintenance Procedure: Underwater Photosynthetically Active Radiation (UPAR)		Date: 2/12/2018
NEON Doc. #: NEON.DOC.002757	Author: D. Monahan, M. Cavileer, G. Simonds	Revision: A

TABLE OF CONTENTS

1 DESCRIPTION.....1

1.1 Purpose 1

1.2 Scope..... 1

2 RELATED DOCUMENTS AND ACRONYMS2

2.1 Applicable Documents 2

2.2 Reference Documents..... 2

2.3 External References 2

2.4 Acronyms 3

2.5 Terminology 3

3 SAFETY AND TRAINING4

4 SENSOR OVERVIEW (SENSORS ONLY)5

4.1 Description 5

4.2 Sensor Specific Handling Precautions 8

4.2.1 Instrument 8

4.2.2 Subsystem 8

4.3 Operation 8

5 INSPECTION AND PREVENTIVE MAINTENANCE9

5.1 Equipment..... 9

5.2 Subsystem Location and Access..... 10

5.3 Maintenance Procedure 10

5.3.1 Remote Monitoring..... 11

5.3.2 Visual Inspection 11

5.3.3 uPAR Sensor Cleaning Requirements..... 13

6 REMOVAL AND REPLACEMENT (SUBSYSTEM ONLY)14

6.1 Equipment..... 14

6.2 Removal and Replacement Procedure..... 14

6.2.1 Grape Removal/Replacement Procedure 15

6.2.2 Inlet/Outlet uPAR Sensor Removal/Replacement Procedure 17

6.2.3 AIS Buoy uPAR Sensor Removal/Replacement 19

Title: NEON Preventive Maintenance Procedure: Underwater Photosynthetically Active Radiation (UPAR)		Date: 2/12/2018
NEON Doc. #: NEON.DOC.002757	Author: D. Monahan, M. Cavileer, G. Simonds	Revision: A

- 6.3 Cleaning & Packaging of Returned Sensor 24
- 6.4 Sensor Refresh Record Management of Assets 25
 - 6.4.1 NEON Asset Management and Logistic Tracking System Requirements 25
- 7 ISSUE REPORTING OUTPUTS 26**
- 8 INLET/OUTLET WINTERIZATION REQUIREMENTS 28**
- 8.1 Equipment 29
- 8.2 Inlet/Outlet Combo Box Battery Removal/Reinstallation Procedure 29
 - 8.2.1 Remove Inlet/Outlet Combo Box Battery 29
 - 8.2.2 Reinstall the Inlet/Outlet Combo Box Battery 31
- 8.3 uPAR Sensor Removal/Reinstallation Procedure 32
 - 8.3.1 Remove the uPAR Sensor 32
 - 8.3.2 Reinstall the uPAR Sensor 32
- 8.4 Winter Maintenance for Operational Sites 32
 - 8.4.1 Equipment 32
 - 8.4.2 Remove Ice from Combo/Key Locks 32
 - 8.4.3 Remove Ice from Cables 32
 - 8.4.4 Remove Snow and/or Ice from Solar Panels 33
- 9 SOURCES 34**

LIST OF TABLES AND FIGURES

- Table 1. Maintenance Equipment List 9
- Table 2. AIS uPAR Maintenance Schedule 10
- Table 3. View Grape and Sensor Data Streams 11
- Table 4. Removal and Replacement Equipment List 14
- Table 5. uPAR Sensor Refresh Requirements 14
- Table 6. Inlet/Outlet uPAR Sensor Removal/Replacement Procedure 17
- Table 7. AIS Buoy uPAR Removal/Reinstallation Procedure 19
- Table 8. D03 FLNT River | AIS Buoy: How to Use uPAR Mount 23
- Table 9. uPAR Sensor Metadata Output Checklist 26
- Table 10. Inlet/Outlet Sensor and Subsystem Winterization Requirements 28
- Table 11. Winterization Equipment Removal Procedure Equipment List 29

Title: NEON Preventive Maintenance Procedure: Underwater Photosynthetically Active Radiation (UPAR)		Date: 2/12/2018
NEON Doc. #: NEON.DOC.002757	Author: D. Monahan, M. Cavileer, G. Simonds	Revision: A

Figure 1. LI-192SA Underwater Quantum Sensor 5

Figure 2. CA03240000 Assy Underwater PAR and Cable Drawing..... 5

Figure 3. uPAR Sensors on AIS Buoy for Lake and River Sites..... 6

Figure 4. Retractable PAR Mounting System | FLNT River Buoy (Source: YSI Integrated Systems & Services) 6

Figure 5. AIS Inlet and Outlet Infrastructure | uPAR Location (D09 PRPO & D18 TOOK)..... 7

Figure 6. AIS Inlet/Outlet PDS and DAS Components (D09 PRPO & D18 TOOK) 7

Figure 7. Lake Inlet/Outlet & AIS Lake Buoy Location 10

Figure 8. uPAR Sensor Close-up on Diffuser 12

Figure 9. Power Down the Grape on the Inlet/Outlet Infrastructure..... 15

Figure 10. Remove Grape from Grape Shields (D06 KING)..... 15

Figure 11. Remove Grape Shield with 3/16" Hex Wrench..... 16

Figure 12. Power Down Site from Combo Box..... 17

Figure 13. Inlet/Outlet Pulley System 17

Figure 14. Remove the uPAR Sensor..... 18

Figure 15. Verify the Leveling Plate is Level..... 18

Figure 16. uPAR Mount Underwater 18

Figure 17. Uvifera (12V) Grape (AD [04])..... 19

Figure 18. Raise the Dual PAR/SUNA Mount on the AIS Buoy..... 20

Figure 19. Use Screwdriver or Nut Driver to Remove uPAR Sensor from Mount 20

Figure 20. Replace with "New" Sensor 21

Figure 21. Secure Sensor in Mount..... 21

Figure 22. Align uPAR Sensor and Cable 22

Figure 23. D03 FLNT River | AIS Buoy: uPAR Mount & Placement..... 22

Figure 24. uPAR Mount Winch..... 23

Figure 25. uPAR Mount Locking Mechanism Example 23

Figure 26. Red Rejected Tag for Defective Assets (MX104219)..... 27

Figure 27. Inlet/Outlet Combo Box..... 29

Figure 28. Solar Panel and Battery Connector from the Junction Board (CB14140000)..... 30

Figure 29. Disconnect Radio Connector (Bottom Right Corner of Combo Box, D18 TOOK)..... 31

Title: NEON Preventive Maintenance Procedure: Underwater Photosynthetically Active Radiation (UPAR)		Date: 2/12/2018
NEON Doc. #: NEON.DOC.002757	Author: D. Monahan, M. Cavileer, G. Simonds	Revision: A

1 DESCRIPTION

1.1 Purpose

NEON sites host sensors that take measurements from air, wind, water, soil, and sun. Regular maintenance of sensors and infrastructure is necessary for the continued operation of the observatory. It is important to identify small problems before they escalate.

This document establishes mandatory procedures and recommended practices for preventive maintenance of the **underwater Photosynthetically Active Radiation (uPAR)** to meet the objectives of the NEON project, and its respective stakeholder and end users.

1.2 Scope

Preventive Maintenance is the planned maintenance of sensors and infrastructure with the goal of ensuring that the instrument and/or infrastructure performs correctly to ensure the collection of the best available science, by preventing excess depreciation and impairment. This maintenance includes, but is not limited to, inspecting, calibrating, adjusting, cleaning, clearing, lubricating, repairing, and replacing, as appropriate. The procedures in this document are strictly preventive and do **not** address corrective actions.

This document addresses preventive maintenance procedures to maintain the LI-COR underwater Photosynthetically Active Radiation (uPAR) sensors at Aquatic Instrument System (AIS) sites. This procedure specifically addresses uPAR sensors for AIS Inlet/Outlet sites (**HB07340000 Subsystem, Underwater Radiation, Lake Inlet/Outlet**, which includes **CA03240000 Lake Inlet and Outlet, Underwater Quantum Sensor**) and AIS Buoy sites (**0348390000 Sensor, Buoy, Underwater PAR**). This includes preventive maintenance procedures and requirements for the instrument, subsystem and supporting infrastructures.

Title: NEON Preventive Maintenance Procedure: Underwater Photosynthetically Active Radiation (UPAR)		Date: 2/12/2018
NEON Doc. #: NEON.DOC.002757	Author: D. Monahan, M. Cavileer, G. Simonds	Revision: A

2 RELATED DOCUMENTS AND ACRONYMS

2.1 Applicable Documents

The following applicable documents (AD) contain mandatory requirements and/or supplementary information that are directly applicable to the topic and/or procedures herein. Visit the [NEON Document Warehouse](#) for electronic copies of these documents.

AD [01]	NEON.DOC.004300	Environmental, Health, Safety And Security (EHSS) Policy, Program and Management Plan
AD [02]	NEON.DOC.004301	EHSS Environmental Protection Manual
AD [03]	NEON.DOC.004316	Operations Field Safety and Security Plan
AD [04]	NEON.DOC.001972	AIS Comm Interconnect Map
AD [05]	NEON.DOC.000620	AIS Verification Checklist
AD [06]	NEON.DOC.001063	NEON Sensor Command, Control and Configuration (C3) Document: Underwater Photosynthetically Active Radiation (UPAR)
AD [07]	NEON.DOC.004613	NEON Preventive Maintenance Procedure: AIS Lake Buoy
AD [08]	NEON.DOC.004608	AIS BUOY VERIFICATION PROCEDURES
AD [09]	NEON.DOC.004456	LAKE INLET / OUTLET DATA ACQUISITION SYSTEM (DAS) FORMAL VERIFICATION PROCEDURES
AD [10]	NEON.DOC.003808	NEON Sensor Command, Control and Configuration (C3) Document: Buoy Meteorological Station and Submerged Sensor Assembly
AD [11]	NEON.DOC.000769	Electrostatic Discharge Prevention Procedure

2.2 Reference Documents

The reference documents (RD) listed below may provide complimentary information to support this procedure. Visit the [NEON Document Warehouse](#) for electronic copies of these documents.

RD [01]	NEON.DOC.000008	NEON Acronym List
RD [02]	NEON.DOC.000243	NEON Glossary of Terms
RD [03]	NEON.DOC.004257	All Systems Standard Operating Procedure: Decontamination of Sensors, Field Equipment, and Field Vehicles
RD [04]	NEON.DOC.001637	NEON Preventive Maintenance Procedure: Aquatic Meteorological (Met) Station
RD [05]	NEON.DOC.003880	NEON Preventive Maintenance Procedure: AIS Stream Infrastructure
RD [06]	NEON.DOC.004429	NEON Preventive Maintenance Procedure: Terrestrial Radiation Sensors
RD [07]	NEON.DOC.002767	AIS Subsystem Architecture, Site Configuration and Subsystem Demand by Site – SCMB Baseline

2.3 External References

External references contain information pertinent to this document, but are not NEON configuration-controlled. Examples include manuals, brochures, technical notes, and external websites.

Title: NEON Preventive Maintenance Procedure: Underwater Photosynthetically Active Radiation (UPAR)		Date: 2/12/2018
NEON Doc. #: NEON.DOC.002757	Author: D. Monahan, M. Cavileer, G. Simonds	Revision: A

ER [01]	LICOR, Inc. LI-192 Underwater Quantum Sensor, https://www.licor.com/env/products/light/quantum_underwater.html
ER [02]	LICOR, Inc. LI-COR Underwater Radiation Sensors Instruction Manual, https://www.licor.com/documents/285ymmolaackjaidu9wao

2.4 Acronyms

Acronym	Explanation
AQU	Aquatic
ESD	Electrostatic Discharge
FLNT	Flint River
kPa	Kilopascal
NM	Nanometer
P/N	Product Number or Part Number
PPFD	Photosynthetic Photon Flux Density
PRPO	Prairie Pothole
PSI	Pounds per Square Inch
S-1	Upstream Sensor Set 1
S-2	Downstream Sensor Set 2
SUNA	Submersible Ultraviolet Nitrate Analyzer
TOOK	Toolik Lake
uPAR	Underwater Photosynthetically Active Radiation
V	Volt

2.5 Terminology

The use of common names for NEON instrumentation and subsystems vary across departments and domains. This section aims to clarify and associate the common names with the technical names herein. The aim of this section is to marry up terms under one name so Technicians are aware of the component referenced in the procedures herein, but also aware they may be called another term in a group discussion with headquarters or training staff.

SYNONYMOUS COMMON NAME(S)	NEON TECHNICAL REFERENCE NAME
Radiation Sensor, PAR, underwater quantum sensor	uPAR (NEON P/N 0320540000 LI-COR LI-192SA) <i>Note: This is a typical PAR sensor underwater. TIS and AIS sites use the same PAR sensor.</i>
Power Box, Comm Box, National Electrical Manufacturers Association (NEMA) Enclosure, Power/Comm Infrastructure	AIS Device Post
Power and Comm Box, NEMA Enclosure	Combination (Combo) Box
Aquatics Instrument System (AIS) power distribution system (PDS) and data acquisition system (DAS), Portal <i>Note: Equivalent to the Instrument Hut for Terrestrial Instrument System (TIS) sites.</i>	Aquatics Portal

Title: NEON Preventive Maintenance Procedure: Underwater Photosynthetically Active Radiation (UPAR)		Date: 2/12/2018
NEON Doc. #: NEON.DOC.002757	Author: D. Monahan, M. Cavileer, G. Simonds	Revision: A

3 SAFETY AND TRAINING

Personnel working at a NEON site must be compliant with safe fieldwork practices in AD [01] and AD [02]. The Field Operations Manager and the Lead Field Technician have primary authority to stop work activities based on unsafe field conditions; however, all employees have the responsibility and right to stop work in unsafe conditions.

All technicians must complete safety training and procedure-specific training to ensure the safe implementation of this protocol per AD [03]. Refer to the site-specific EHSS plan via the NEON Safety document portal for electronic copies.

Preventive maintenance of AIS Infrastructure may require the use of special equipment to access the sensor subsystem assemblies. Follow Domain site-specific [EHS plans via the Network Drive](#) and NEON safety training procedures when conducting maintenance activities. Conduct a Job safety Analysis (JSA) prior to accessing the sensor subsystems onsite. Reference the [Safety Office SharePoint portal](#) for JSA templates and additional hazard identification information.

In the event current methods to conduct the procedures herein are no longer safe for use due to unforeseen or unknown site dynamics, consult with the NEON Safety Office via the NEON Project’s Issue Management and Reporting System (i.e., JIRA or ServiceNow) for alternative methods to conduct TIS and AIS preventive/corrective maintenance and Sensor Refresh procedures.

Title: NEON Preventive Maintenance Procedure: Underwater Photosynthetically Active Radiation (UPAR)		Date: 2/12/2018
NEON Doc. #: NEON.DOC.002757	Author: D. Monahan, M. Cavileer, G. Simonds	Revision: A

4 SENSOR OVERVIEW (SENSORS ONLY)

4.1 Description

The LI-COR LI-192SA Underwater Quantum Sensor (Figure 1) is the uPAR model the NEON project is currently employing at specific AIS sites. The uPAR measures PAR in aquatic environments from all angles in one hemisphere and works underwater at depths up to 560 meters.ⁱ The sensor uses a silicon photodiode and glass optical filters to create uniform sensitivity to light between 400 nm to 700 nm, which closely corresponds to light used by most aquatic plants and algae. An optical filter blocks light with wavelengths beyond 700 nanometer (nm), which is critical for measurements in a water column, where the ratio of infrared to visible light may be high.ⁱⁱ The measurements are cosine corrected and typically expressed as Photosynthetic Photon Flux Density (PPFD).ⁱⁱⁱ



Figure 1. LI-192SA Underwater Quantum Sensor

The uPAR exterior consists of corrosion resistant metal cylinder with an acrylic end diffuser suitable for both saltwater and freshwater applications. Waterproof to withstand approximately 5500 kPa, 560 meters (800 psi). The sensor operating temperature range is -40 °C to 65 °C. The NEON assembly provides these sensors to FOPs with a cable (Figure 2).

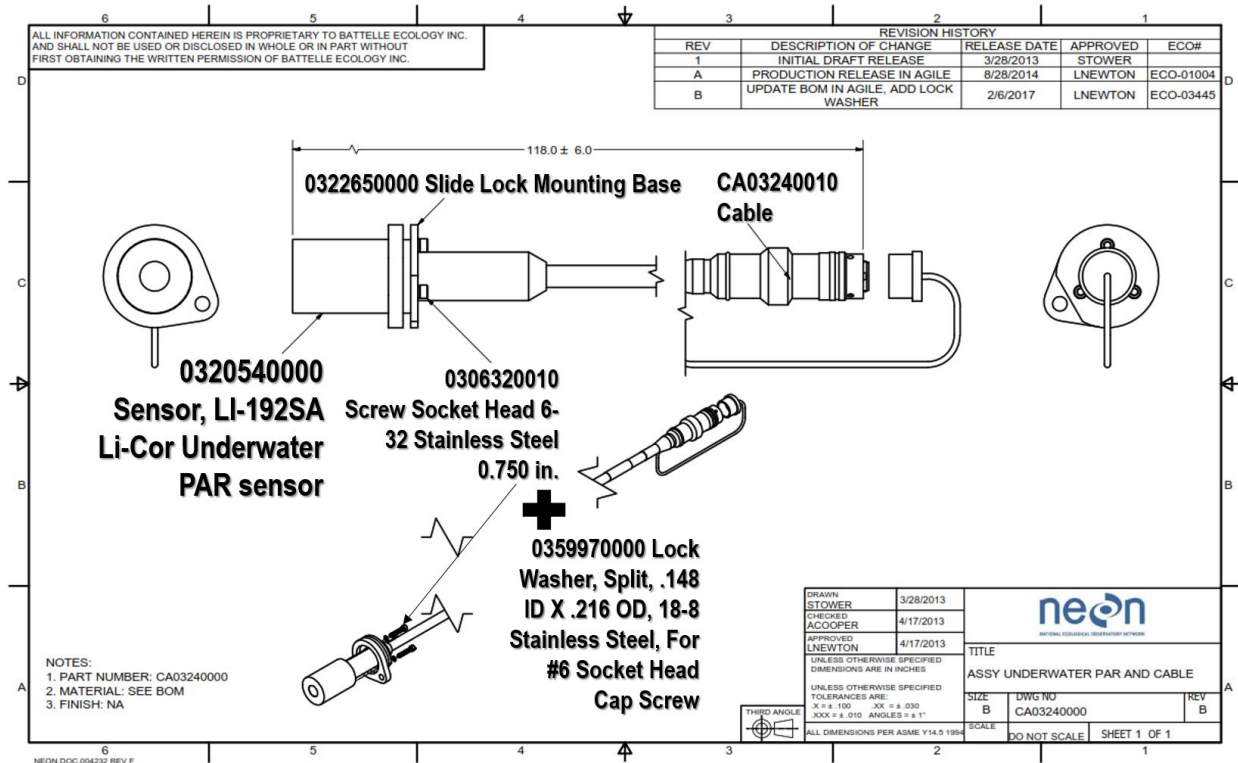

Figure 2. CA03240000 Ass'y Underwater PAR and Cable Drawing

The NEON project uses uPAR sensors to measure underwater photosynthetically active radiation at AIS Lake/River Buoy and Inlet/Outlet lake sites. Figure 3 provides an overview of the uPAR sensors on the AIS Buoy for lake and river sites, with the exception of the Buoy on Flint River (FLNT) in Domain 03.

Title: NEON Preventive Maintenance Procedure: Underwater Photosynthetically Active Radiation (UPAR)		Date: 2/12/2018
NEON Doc. #: NEON.DOC.002757	Author: D. Monahan, M. Cavileer, G. Simonds	Revision: A

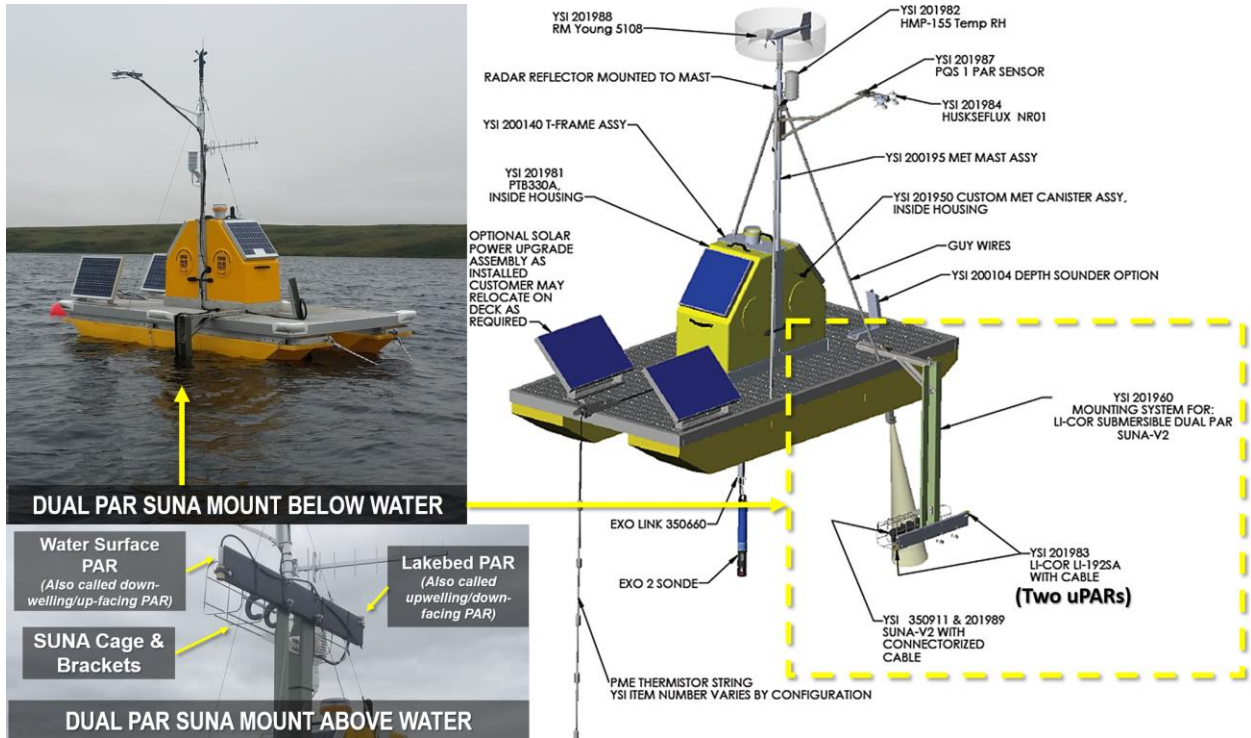

Figure 3. uPAR Sensors on AIS Buoy for Lake and River Sites

The AIS Buoy design for FLNT is unique. The uPAR sensors are the same; however, their mount differs. Figure 4 is a drawing of the design (the site is currently under development).

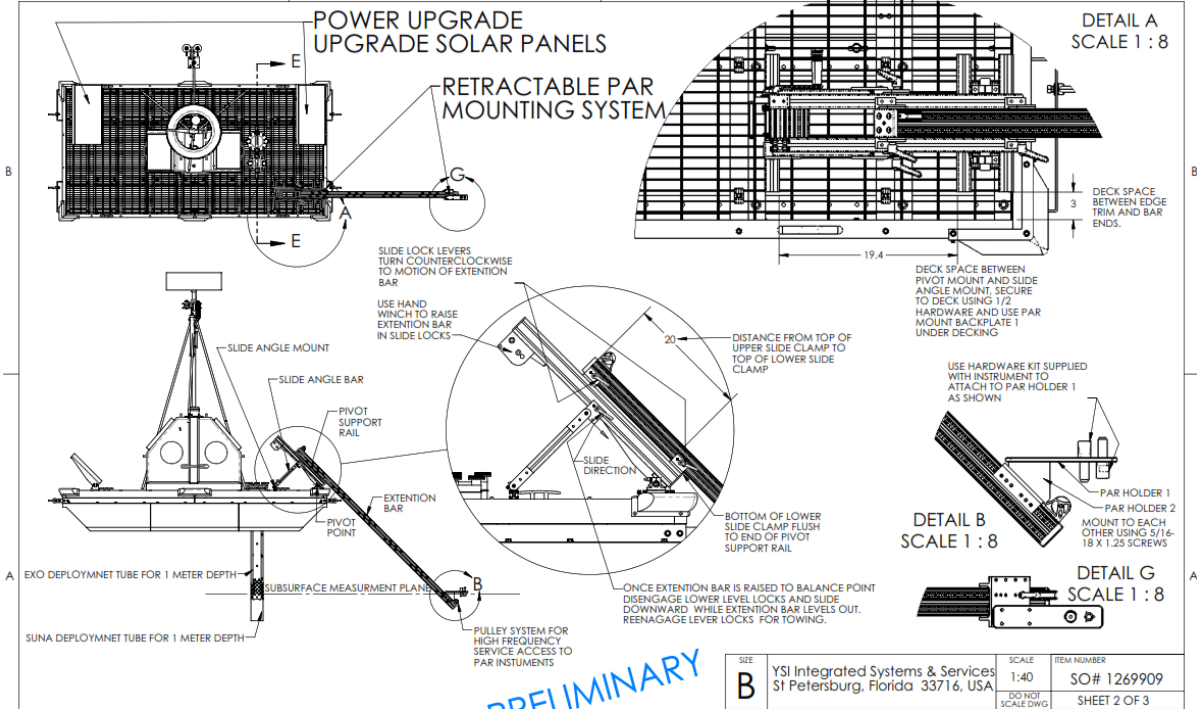

Figure 4. Retractable PAR Mounting System | FLNT River Buoy (Source: YSI Integrated Systems & Services)

Figure 5 displays the uPAR sensor for AIS inlet and outlet locations. These locations use one uPAR each.

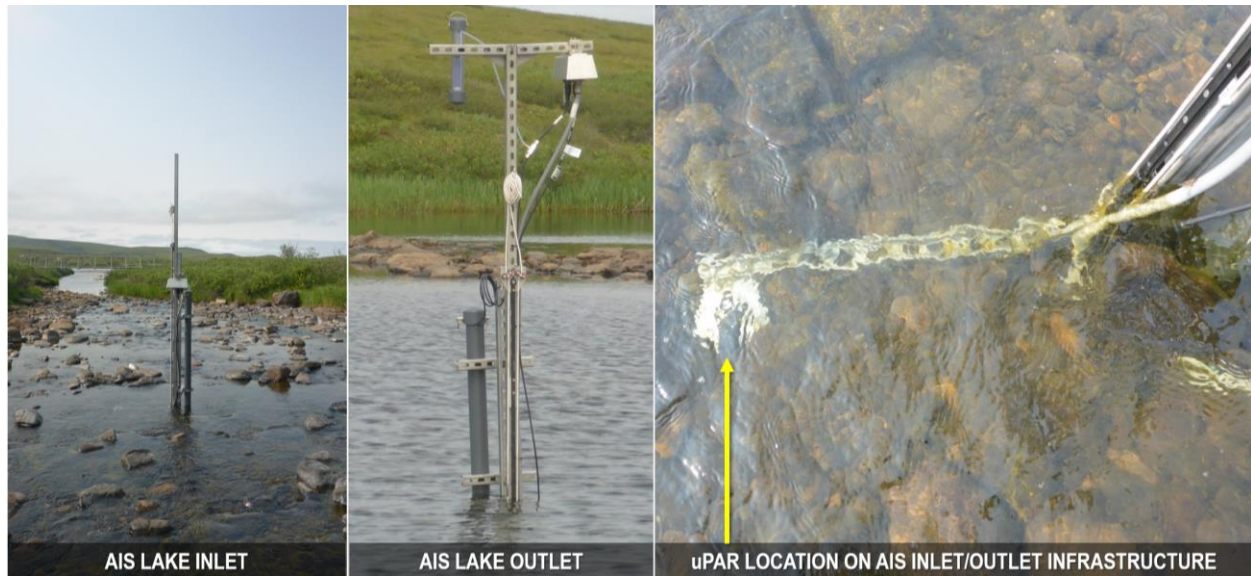

Figure 5. AIS Inlet and Outlet Infrastructure | uPAR Location (D09 PRPO & D18 TOOK)

The uPAR subsystem varies per sensor installation location. However, both systems use radios to transmit data to the Aquatics Portal. The uPAR sensors on the AIS Buoy receive power from the AIS Buoy solar/battery system and transmit data through the AIS Buoy data acquisition system (DAS). *Reference AD [07] for additional information on the AIS Buoy infrastructure.* For the lake inlet/outlet installations, the uPAR shares a Uvifera^{iv} (12V) Grape with the Level TROLL, which connects to a device post onshore (Figure 6).

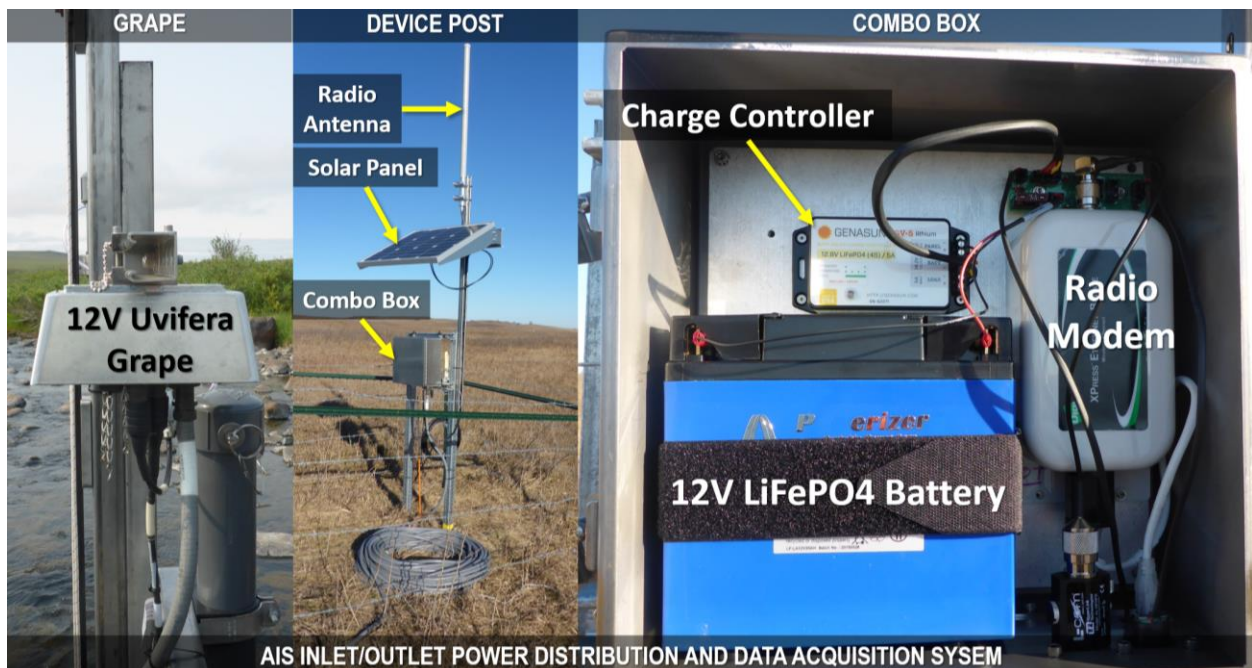

Figure 6. AIS Inlet/Outlet PDS and DAS Components (D09 PRPO & D18 TOOK)

Title: NEON Preventive Maintenance Procedure: Underwater Photosynthetically Active Radiation (UPAR)		Date: 2/12/2018
NEON Doc. #: NEON.DOC.002757	Author: D. Monahan, M. Cavileer, G. Simonds	Revision: A

The Inlet/Outlet device post and combo box design are almost identical to the GWW subsystem device post and combo box. The radio transmits data from the inlet/outlet sensors to the Aquatics Portal.

4.2 Sensor Specific Handling Precautions

4.2.1 Instrument

The uPAR sensor contains sensitive optical components. Do not use a dry brush to remove biofouling from these sensors. Do not use alcohol and organic solvents to clean the sensor. It affects the sensor response. Use care when positioning or adjusting the sensor; do not touch the sensor head. Dirt and oils on hands may cause biases in measurement collection. These sensors also require ESD shipping and handling (reference [AD \[11\]](#)).

4.2.2 Subsystem

Grapes contain Electrostatic discharge sensitive parts; therefore, all Grapes require ESD (antistatic) packaging and handling during inter- and intra-site transport, reception, and storage. As a rule, when handling (installing, removing, and servicing) these electrical components, all Technicians must ground themselves (reference [AD \[11\]](#)). Conduct [Lockout/Tagout \(LOTO\)](#) procedures to disable machinery or equipment over 50 volts to prevent the release of hazardous energy while performing service and maintenance activities.

4.3 Operation

The AIS buoy uses two uPAR sensors to capture simultaneous measurements of downwelling and upwelling PAR at AIS Buoy river and lake sites. A uPAR sensor resides at each Inlet and Outlet location to measure downwelling PAR. Per [AD \[06\]](#), the uPAR...”shares a data product with other AIS deployments, specifically lake and river buoys ([AD \[10\]](#)). The data streams are the same for all deployments...but the frequency at which data is returned may be different on the buoy compared to [other] AIS deployments.”

Reference [AD \[06\]](#) and [AD \[10\]](#) for the command, control and configuration of this sensor. NEON HQ data quality personnel may flag the data with the help of FOPS Technicians reporting events using the NEON project Issue Management and Reporting System using the “**AIS Data Quality**” tag in the ticket, title and/or description.

5 INSPECTION AND PREVENTIVE MAINTENANCE

5.1 Equipment

 Note: When working on power systems, use tools with insulated handles.

Table 1. Maintenance Equipment List

P/N	NEON P/N	Description	Quantity
Tools			
GENERIC		Flush cutters/Scissors (to remove zip-ties)	1
GENERIC		Landscaping tools (to maintain vegetation around onshore subsystems)	A/R
NEON, IT		NEON Laptop (to connect to network in Aquatics Portal)	1
GENERIC		Ethernet Cable (to connect to network in Aquatics Portal)	1
GENERIC		Hex Wrench Set (for sensor swap/refresh)	1
GENERIC		Screwdriver (to access AIS device post combo boxes)	1
GENERIC		Aquatic PPE + Boat PPE	A/R
4620	MX103120	3M Antistatic Wristband (ESD Requirement)	1
GENERIC		Wash Bottle (for cleaning mixture or DI water)	1-2
GENERIC		5 Gallon Bucket (to catch cleaning materials/use to prevent contamination to aquatic sites)	1
		Dry Brush (to remove biofouling/corrosion from infrastructure)	1-2
7187T23	0359490000	McMaster- Carr Supply Co. Hand Brush (to remove biofouling/corrosion from stainless steel/aluminum infrastructure)	1-2
		Digital and/or Bubble Level (for leveling the uPAR on inlet/outlet)	1
Consumable Items			
GENERIC		Paint pen/Sharpie Marker (to label infrastructure)	1
MS3181-10C MS3181-12C RJFC2G/SCP3181-18C-NEON	CB08180000	Kit, Grape Dust Caps (Amphenol caps for Ethernet cables/Uvifera Grape)	A/R
GENERIC		Lint-free/microfiber cloths	A/R
34120	MX100642	Kimwipes/Cotton Swabs	1 Box
GENERIC		DI Water	A/R
GENERIC		5% acid white vinegar solution diluted by 50% water mixture	A/R
GENERIC		Clean tap water	1 Gallon
0719752		7" Zip-ties (to re-dress cables, as applicable)	A/R
0719793		14" Zip-ties (to re-dress cables, as applicable)	A/R
210-01958-1		LI-COR Dow Corning 111 (silicone grease to lubricate specific cable connections)	1
Resources			
		PuTTY: http://www.putty.org/ or MobaXterm https://mobaxterm.mobatek.net/	1
		SAS: http://sas.ci.neoninternal.org/	1
		Site Specific IP Addresses: N:\Common\SYS\Site Network Configurations	A/R
		Location Controller Username: user, password: resuresu	1

5.2 Subsystem Location and Access

The uPAR sensors reside at AIS lake sites on the inlet/outlet infrastructure and the Buoy (Figure 7) and at river sites on the Buoy. Subsystem components reside with the sensors on the infrastructure and onshore nearby. Access to these sites requires a boat and Aquatic PPE prescribed by references in Section 3 Safety and Training.

The NEON project also uses above water PAR sensors at AIS sites (I.e., at S-1/S-2, the Aquatic MET station, and on the AIS Buoy MET mast). For the maintenance of above water PAR sensors, reference RD [06].

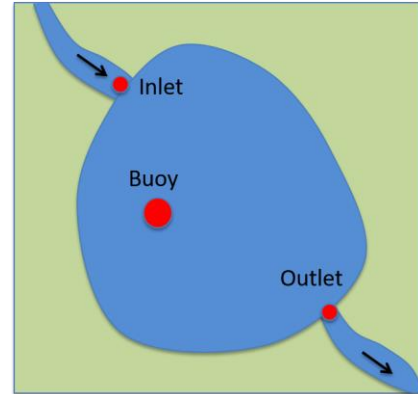

Figure 7. Lake Inlet/Outlet & AIS Lake Buoy Location

Note: Refer to site-specific As-Built documentation in the [NEON SharePoint Document Warehouse](#) to verify site-specific AIS Infrastructure and Sensor subsystems.

5.3 Maintenance Procedure

Table 2. AIS uPAR Maintenance Schedule

Maintenance	Bi-weekly	Quarterly	Annual	As Needed	Type
AIS UNDERWATER PAR SENSOR					
Remote Monitoring	X			X	P
Visual Inspection of Sensor	X			X	P
Sensor Leveling and Cleaning	X	X		X	P
Winter Preparation for AK			X	X	P
Electrical & Communications Infrastructure					
Remote Monitoring	X				P
Visual Inspection	X				P
Replace Cable Ties				X	R
Clean Biofouling from Cables/Wires				X	P/R
Clean Solar Panels		X			P/R
Winter Preparation for AK			X		P
Winter Maintenance for Operational Sites				X	P
Inlet/Outlet Pulley System Infrastructure					
Visual Inspection	X				P
Function Check				X	P
Cleaning/Corrosion Removal				X	P/R
NOTE: The biweekly and annual inspections should be carried out regardless of whether they coincide or not. P = Preventive, R = Repair, X = Indicates preventive maintenance task time interval may increase due to environmental (season/weather) or unforeseen/unanticipated site factors.					

Title: NEON Preventive Maintenance Procedure: Underwater Photosynthetically Active Radiation (UPAR)		Date: 2/12/2018
NEON Doc. #: NEON.DOC.002757	Author: D. Monahan, M. Cavileer, G. Simonds	Revision: A

5.3.1 Remote Monitoring

Conduct remote monitoring daily using the [SAS report](#). To access static smart devices onsite, reference site-specific IP Addresses/Network Configurations via the NEON Network Drive ([N:\Common\SYS\Site Network Configurations](#)). Prior to traveling to the site, conduct a state of health check at the Domain on the sensors via their data streams using the SAS report for a daily snapshot or use terminal emulator program (TEP), such as PuTTY or MobaXterm, for real-time review of data streams. This action enables Technicians to prepare and prioritize any root cause analysis/corrective action to sensors onsite with missing or abnormal data streams on the uPAR sensors. Verify data streams using Table 3.

 **PRO TIP:** To perform these functions, Technicians must acquire the Grape MAC address and/or the EEPROM ID (from Maximo) of the sensor. Use this to verify function of Grapes and Sensors post-Sensor Refresh, too.

Table 3. View Grape and Sensor Data Streams

Remote Monitoring Commands	Description
<code>vd grep [MAC address]</code>	This displays the data from the grape with the MAC Address entered (e.g., using “7CE0440015FD”). Enter either in decimal or hexadecimal format. Use “ grep -i ” to ignore case.
<code>vd -s [sensor eeprom id]</code>	To view data from a sensor. For example “root@D23-HQTW-LC1:~# vd -s 3171982”
<code>vd -s [sensor eeprom id] -r [stream number]</code>	To view data from a sensor and specific data stream.

5.3.2 Visual Inspection

An objective of AIS is to measure natural conditions. Maintenance of the infrastructure must result in little to no disturbance to the natural conditions of the AIS site. Employ care and use sound judgement when conducting maintenance on the site to mitigate or reduce our impacts to the site.

Conduct a visual inspection on components onsite to maintain structural integrity, science and engineering requirements. If the following tasks require corrective action, submit a ticket in the NEON project Issue Management and Reporting System.

1. Inspect the uPAR sensor and infrastructure for fallen debris/trash, vandalism, or if any components seem out of place or display evidence of tampering (if sensors are not in their configured location, etc.).
2. Inspect components for damage and/or if their installation location is no longer meeting science requirements due to seasonal changes or inclement weather events.
 - a. Verify instruments are in accordance with site-specific science requirements. Refer to site-specific As-Built documentation in the [NEON SharePoint Document Warehouse](#) to verify site-specific AIS sensors and subsystems.

Title: NEON Preventive Maintenance Procedure: Underwater Photosynthetically Active Radiation (UPAR)		Date: 2/12/2018
NEON Doc. #: NEON.DOC.002757	Author: D. Monahan, M. Cavileer, G. Simonds	Revision: A

3. Raise sensor mounts for the Inlet/Outlet and AIS Buoy to test the function of the infrastructure. Be careful to watch for snakes/biologics during this procedure. *Reference N:\Common\EHS to review Domain EHS plans to identify local potential hazards.*
 - a. Inspect sensor for physical damage and biofouling. To maintain appropriate cosine correction, the vertical edge of the diffuser must be kept clean (Figure 8). Additionally, the upper edge of the cylindrical body should be free of any protruding biological biofouling that might interfere with PAR reception.

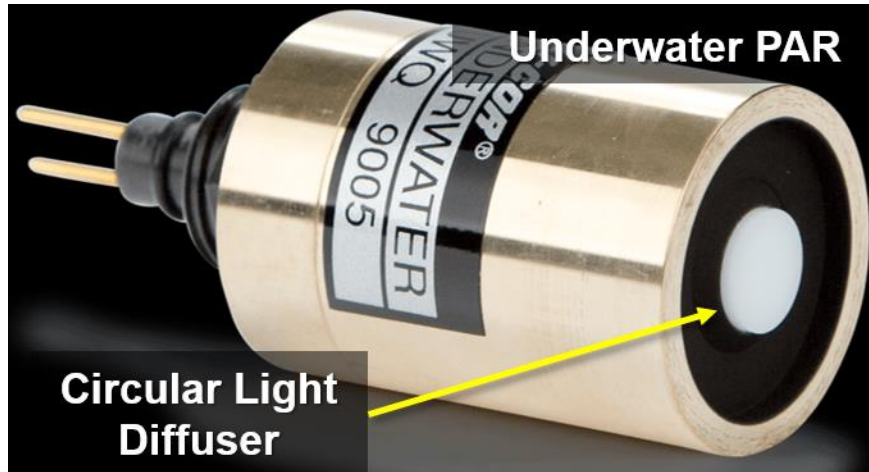



Figure 8. uPAR Sensor Close-up on Diffuser

4. Inspect vegetation growth around sensor infrastructure and device posts.
 - a. Seasonal and environmental conditions may enable the growth of aquatic plant life. Emergent or floating aquatic plants may shade the uPAR sensor. In this situation, submit a ticket with photographic evidence for AIS data quality and clear a 1-meter clearance around the inlet/outlet and AIS Buoy uPAR infrastructure.
 - b. Trim vegetation around the onshore device posts to enable safe access to components requiring maintenance and/or troubleshooting.
5. Inspect the cables and connectors connecting to the sensor and device posts.
 - a. Re-dress cables/replace cable ties, as appropriate.
 - b. Verify connectors that are not in use have covers/dust caps installed.
 - c. Check for evidence of corrosion, tampering, fraying, kinks or loose connections.
 - d. The underwater cable(s) should attach to the frame for approximately 25 cm of cable to form a smooth arc to the underwater sensor connector. The cable(s) require restraint from flexing or supporting any weight, but not tight enough to cause damage, and not loose enough to slip or put strain on the sensor connector.

Title: NEON Preventive Maintenance Procedure: Underwater Photosynthetically Active Radiation (UPAR)		Date: 2/12/2018
NEON Doc. #: NEON.DOC.002757	Author: D. Monahan, M. Cavileer, G. Simonds	Revision: A

 *Note: New sensor cables from LI-COR are pre-lubricated with a thin film of silicone grease at the factory. The sensor connector may require lubrication periodically with a silicone grease (e.g. Dow Corning 111, available from LI-COR under P/N 210-01958-1 in Table 5) before installing it in the mating connector of the underwater cable.*

6. Inspect infrastructure mechanical components and associated AIS Device Post. Check structural integrity of Unistrut post, enclosures, cables, mounts, bolts, nuts, washers, and screws, etc.
 - a. Ensure there are no insects/insect nests/rodents and/or rodent damages in the enclosures or to any of the other components (such as rodent damage to conduit). Employ caution and remove insect nests. Consult with the Domain Manager and NEON Safety Office in the event additional guidance is necessary to remove biologics.
 - b. If a site has cattle, verify structural components are intact and free from damage caused by cattle or ruminants grazing near the infrastructure.
 - c. Inspect component hardware for deterioration (rust, corrosion, oxidation, etc.).
 - i. If corrosion is present, attempt to clean/remove it with a wire hand brush (see Table 1 for specific equipment information). Replace hardware, as applicable.
 - d. Inspect the Combo box door gaskets and strap to ensure they are not enabling water intrusions or biologics into the enclosure.
 - e. Inspect solar panels for debris, snow, or ice, and clean solar panels. If snow and/or ice are present on the panels, conduct the preventive maintenance procedures in *Section 8.4 Winter Maintenance for Operational Sites on page 32*.
7. For inlet/outlet infrastructure, verify the sensor is level from the leveling plate. If the infrastructure is more than 5° out of alignment in any direction, submit a ticket for AIS Science Staff to review and determine if corrective actions are necessary. *See Table 6. Inlet/Outlet uPAR Sensor Removal/Replacement Procedure for additional information on leveling the sensor.*
 - a. Due to the dynamic nature of the AIS Buoy in water, the sensors on the buoy do not require leveling.

5.3.3 uPAR Sensor Cleaning Requirements

When cleaning uPAR sensors (or PAR sensors in general), please be aware that the acrylic material is highly sensitive and alcohol and organic solvents cause [crazing](#) (tiny lines/cracks), which affects the sensor response. Avoid touching the sensor surface when cleaning to minimize the potential of scratching the sensor.

For preventive maintenance, use a lint-free lens cleaning wipe or DI water with a lint-free/microfiber cotton cloth/Kimwipes to remove biofouling on the top surface and vertical sides of the circular light diffuser (*see Figure 8. uPAR Sensor Close-up on Diffuser for location*). If mineral deposits are visible, clean using a lint-free/microfiber cotton cloth and a 5% acid white vinegar solution diluted by 50% water. Capture all cleaning liquids in a bucket to prevent contaminating the AIS site.

6 REMOVAL AND REPLACEMENT (SUBSYSTEM ONLY)

6.1 Equipment

Table 4. Removal and Replacement Equipment List

P/N	MX/NEON P/N	Description	Quantity
Tools			
GENERIC		Flush cutters/Scissors (to remove zip-ties)	1
		NEON Laptop w PuTTY or MobaXterm	1
		Extra Ethernet cable (to verify sensor function via portal onsite)	
GENERIC		Hex Key/Wrench Set	1
GENERIC		Wrench Set	1
		Digital Level (for reinstallation of sensor, as appropriate)	1
GENERIC		Aquatic + Boat PPE	A/R
4620	MX103120	ESD Wrist Strap (to follow ESD protocols)	1
GENERIC		#2 Philips head screwdriver (to open power boxes)	1
GENERIC		7/16" Open End / Box Wrench	2
GENERIC		3/16" Allen Driver	1
Consumable Items			
3M		ESD Bags (for uPAR swaps)	3
		Amphenol caps (for Ethernet cables/Grapes)	2-4
0719752		7" Zip-ties (to redress cables, as applicable)	A/R
0719793		14" Zip-ties (to redress cables, as applicable)	A/R
GENERIC		Contractor Trash Bags	A/R
		uPAR Sensor Protective Caps	

 **Note:** When working on power systems, use tools with insulated handles. Always shut down the power prior to removing or replacing any components. Do not hot-swap (Power is ON) any component or sensor connections at AIS sites.

6.2 Removal and Replacement Procedure

The Field Operations Domain Manager is responsible for managing the removal and replacement of the sensors onsite for preventive maintenance and/or sensor swaps and manages field calibration and validation of sensors, as appropriate. The NEON project Calibration, Validation and Audit Laboratory (CVAl) is responsible for the calibration and validation of select sensors and manages Domain sensor refresh (swap) schedules.

To minimize data downtime and optimize the availability of sound data, please coordinate the instrumentation and subsystem annual calibration, validation and preventive maintenance requirements to occur within the same timeframe. See Table 5 for sensor refresh requirements for the subsystem infrastructure on the uPAR Sensor.

Table 5. uPAR Sensor Refresh Requirements

	LOCATION		TIMEFRAME			COMMENTS
	CVAl	FIELD	BIWEEKLY	ANNUAL	NA	
uPAR Sensor	X			X		Follow ESD protocol
Uvifera (12V) Grape	X			X		Follow ESD protocol

6.2.1 Grape Removal/Replacement Procedure

1. Employ ESD protocols when handling Grapes. Reference [AD \[11\]](#).
2. Power down the site at the AIS Device Post Combo Box. Disconnect the armored Ethernet cable connecting to the Combo Box (Figure 9).

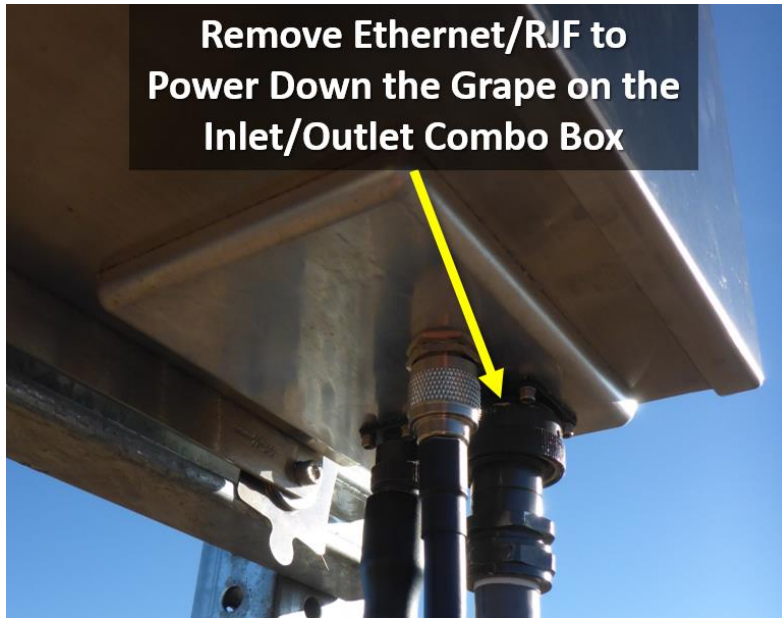

Figure 9. Power Down the Grape on the Inlet/Outlet Infrastructure

3. Disconnect the armored Ethernet cable connecting to the RJF/Eth to Comm connection.
4. Disconnect sensor connection(s).
5. Remove Uvifera (12V) Grape from Grape Shield (Figure 10). Remove the four screws that affix the Grape to the Grape Shield using a hex wrench.



Figure 10. Remove Grape from Grape Shields (D06 KING)

Title: NEON Preventive Maintenance Procedure: Underwater Photosynthetically Active Radiation (UPAR)		Date: 2/12/2018
NEON Doc. #: NEON.DOC.002757	Author: D. Monahan, M. Cavileer, G. Simonds	Revision: A

- If there is a need to remove the Grape Shield from the Inlet/Outlet Infrastructure, remove the Grape Shield mount/clamp using a 3/16" hex wrench (Figure 11).



Figure 11. Remove Grape Shield with 3/16" Hex Wrench

 **PRO TIP:** It is easier to reinstall the Grape in the Grape Shield when the mount is removed from the infrastructure.

- Install dust caps on Amphenol connectors of old Grape.
- Reinstall new Grape to the Grape Shield by threading the four screws that affix the Grape to the Grape Shield using a hex wrench.
- Remove dust caps on sensor connectors and Eth-To-Comm connector. Re-connect sensor and armored Ethernet cable in accordance with [AD \[04\]](#).
- Re-energize the site and verify Grape and uPAR Sensor function. Connect locally to the Aquatics Portal or from the Domain using a TEP and Table 3.

Title: NEON Preventive Maintenance Procedure: Underwater Photosynthetically Active Radiation (UPAR)		Date: 2/12/2018
NEON Doc. #: NEON.DOC.002757	Author: D. Monahan, M. Cavileer, G. Simonds	Revision: A

6.2.2 Inlet/Outlet uPAR Sensor Removal/Replacement Procedure

Table 6. Inlet/Outlet uPAR Sensor Removal/Replacement Procedure



Figure 12. Power Down Site from Combo Box

STEP 1 | Power down the site (Figure 12).

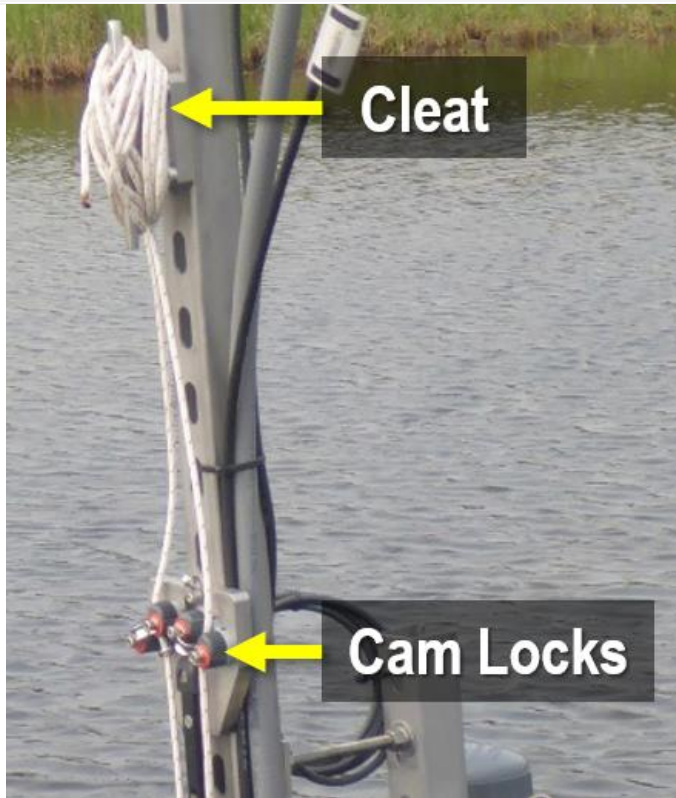

Figure 13. Inlet/Outlet Pulley System

STEP 2 | Use the Inlet/Outlet pulley to raise the uPAR infrastructure and mount above water. Conduct the following steps to use the pulley with Figure 13:

1. Remove the rope from the cleat near the top of the Unistrut to provide slack for movement.
2. At the cam locks, pull the two ropes toward you to release them from the cam locks. One rope may remain in a cam lock, if it is easier.
3. Using the rope, test function/rope movement direction. Installations may vary on which side moves up/down.
4. Move the uPAR infrastructure above water to remove/reinstall the uPAR sensor.
5. To lock uPAR infrastructure position, place the rope back into the cam locks and tie off at the cleat.

Title: NEON Preventive Maintenance Procedure: Underwater Photosynthetically Active Radiation (UPAR)		Date: 2/12/2018
NEON Doc. #: NEON.DOC.002757	Author: D. Monahan, M. Cavileer, G. Simonds	Revision: A

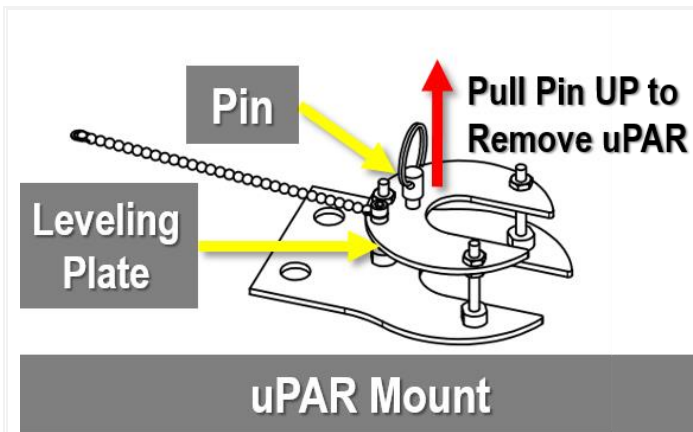

Figure 14. Remove the uPAR Sensor

STEP 3 | Remove the uPAR sensor by removing the pin from its mount (Figure 14).

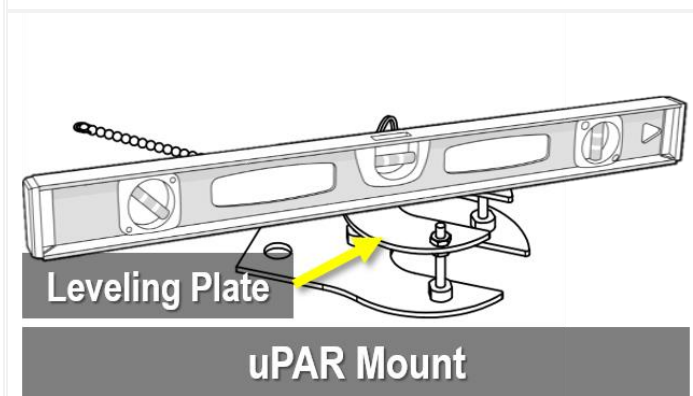

Figure 15. Verify the Leveling Plate is Level

STEP 4 | Verify the leveling plate is level before installing the new “refreshed” uPAR sensor (Figure 15).

If the leveling plate is not level, adjust the leveling nuts until the leveling plate is level. Be sure to lock the leveling nuts at each leveling stud after verifying that the plate is now level.

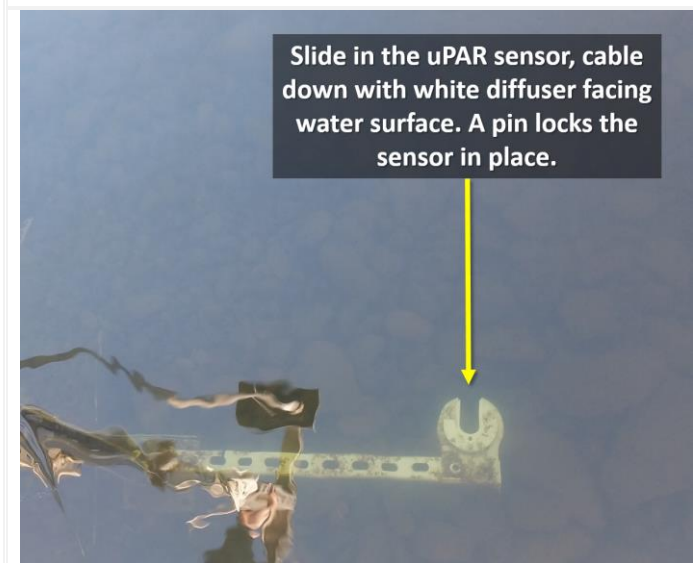

Figure 16. uPAR Mount Underwater

STEP 5 | Reinstall new “refreshed” uPAR sensor (Figure 16).

Figure 16 displays the uPAR mount underwater without a sensor for clarity; however, for this step the mount is likely above water.

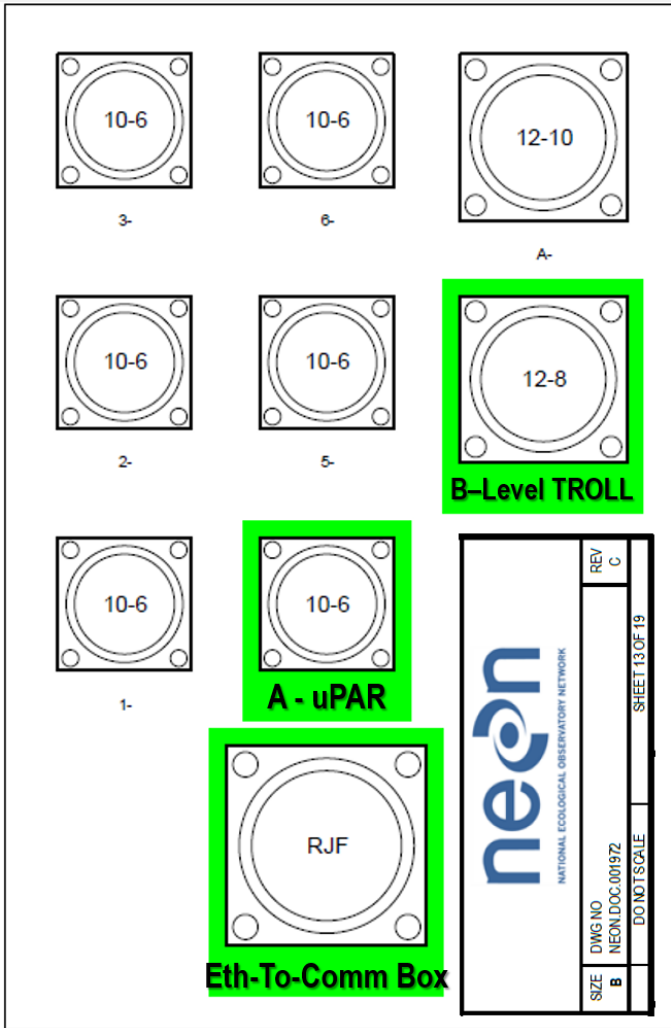

Figure 17. Uvifera (12V) Grape (AD [04])

STEP 7 | Connect sensor to Uvifera (12V) Grape per [AD \[04\]](#) in Figure 17.

Employ ESD protocols per [AD \[11\]](#).

STEP 6 | Reconnect the armored Ethernet cable to the Combo box to return power to the site (reference Figure 12 above).

STEP 6 | Verify sensor function post reinstallation. *Reference Section 5.3.1 Remote Monitoring.*

6.2.3 AIS Buoy uPAR Sensor Removal/Replacement

Table 7 provides a guideline to remove and reinstall two uPAR sensors on the AIS Buoy. *Reference AD [07] for comprehensive information to conduct AIS Buoy preventive maintenance.*

Table 7. AIS Buoy uPAR Removal/Reinstallation Procedure

STEP 1 | The power may remain ON, as long as an **AIS Data Quality** ticket is submitted with the timeframe and a brief description of the maintenance scope work. Otherwise, power down the AIS Buoy in

Title: NEON Preventive Maintenance Procedure: Underwater Photosynthetically Active Radiation (UPAR)		Date: 2/12/2018
NEON Doc. #: NEON.DOC.002757	Author: D. Monahan, M. Cavileer, G. Simonds	Revision: A

accordance with AD [07] to act as a “flag” for data quality.

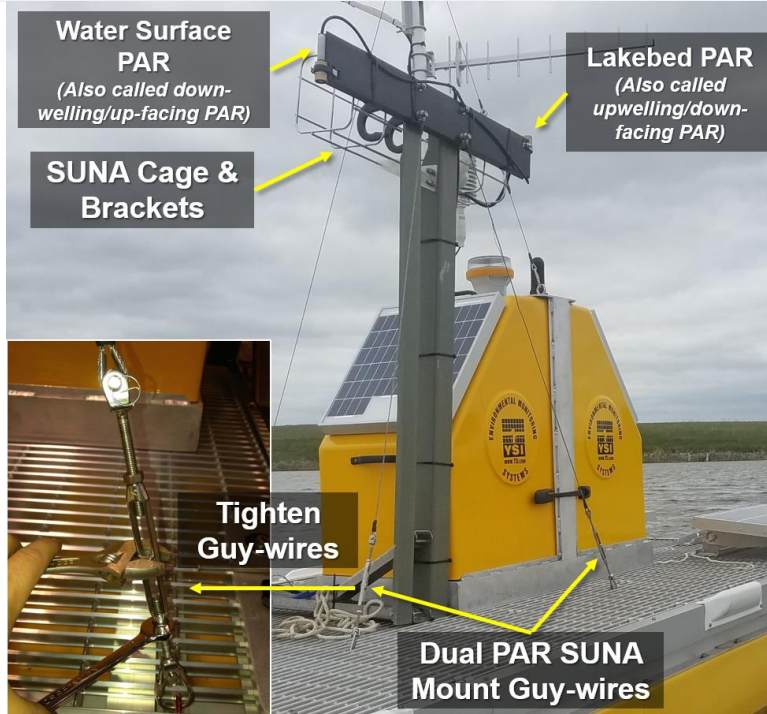

Figure 18. Raise the Dual PAR/SUNA Mount on the AIS Buoy

STEP 2 | Disconnect the two locking carabineers from the eyebolts on the side of the buoy stabilizing the mount underwater. Lift the mount to seat on the deck per Figure 18. Secure the mount to the deck using the guy-wire turnbuckles.

Reference AD [07] for additional graphics and guidance.

For Domain 03 (D03), Flint River (FLNT) AIS Buoy, please reference the next section for additional instructions to address the variations in the AIS Buoy model.



Figure 19. Use Screwdriver or Nut Driver to Remove uPAR Sensor from Mount

STEP 3 | Use a flathead screwdriver to remove the uPAR sensor from the Dual PAR/SUNA Mount (Figure 19).

Place black plastic caps at the optical end of the sensor.

PRO TIP: For sites removing the uPAR sensors for winterization of the AIS Buoy, use electrical tape to differentiate between the two to aid reinstallation.

Title: NEON Preventive Maintenance Procedure: Underwater Photosynthetically Active Radiation (UPAR)		Date: 2/12/2018
NEON Doc. #: NEON.DOC.002757	Author: D. Monahan, M. Cavileer, G. Simonds	Revision: A



Figure 20. Replace with "New" Sensor

STEP 4 | Place a new “refreshed” sensor in the Dual PAR/SUNA mount (Figure 20).

For winterization, reinstall the uPAR bracket hardware (i.e., thread screw back in pipe clamp) without the sensor.



Figure 21. Secure Sensor in Mount

STEP 5 | Use a screwdriver or Nut Driver to secure the “refreshed” uPAR sensor on the Dual PAR/SUNA Mount (Figure 21).

 *Note: Maintain the AIS Buoy sensor sets asset tags in the AIS Lake Buoy battery box or closest onshore device post (e.g., the Aquatics Portal). Use option one or option two, do not split up tags between the two options. Do not send a sensor to CVAL without its asset tag.*

Title: NEON Preventive Maintenance Procedure: Underwater Photosynthetically Active Radiation (UPAR)		Date: 2/12/2018
NEON Doc. #: NEON.DOC.002757	Author: D. Monahan, M. Cavileer, G. Simonds	Revision: A

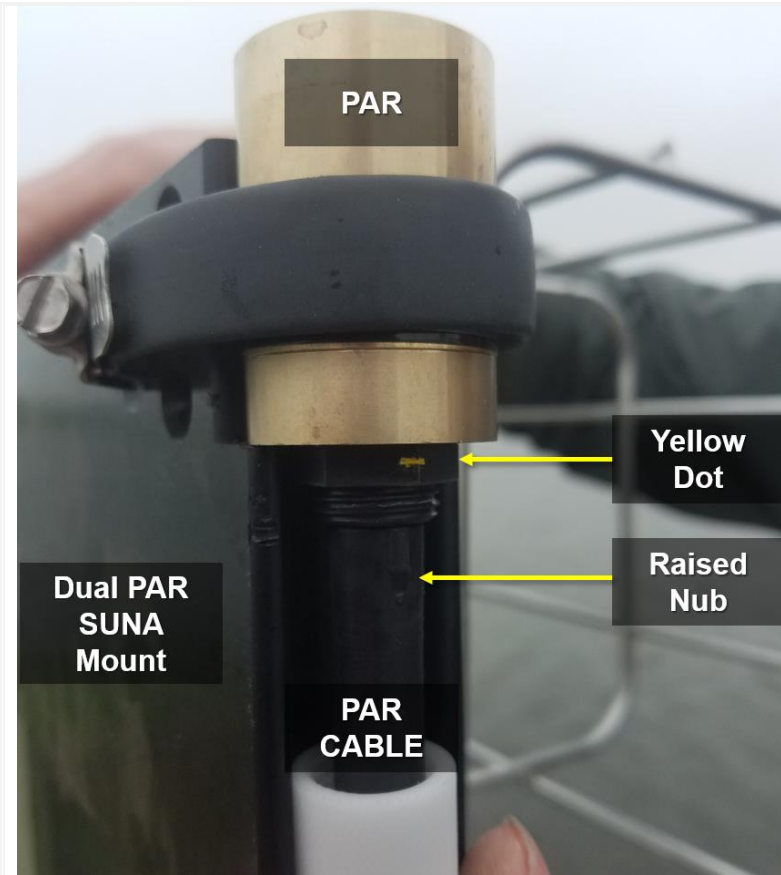

Figure 22. Align uPAR Sensor and Cable

STEP 6 | In the event the uPAR is not connected to its cable, use Figure 22 as a guide.

The yellow dot and raised nub must align to connect the cable to the sensor.

If the dots do not align, this may result in a negative reading on the readout device due to the change in polarity of the conductors.

Note: The sensor connector may need periodic lubrication with a silicone grease (e.g. Dow Corning 111, available from LICOR under product number 210-01958-1) before installing it in the mating connector of the underwater cable.

STEP 7 | Verify sensor function on post reinstallation. Reference Section 5.3.1 Remote Monitoring.

6.2.3.1 FLNT River uPAR Removal/Reinstallation

The AIS Buoy at Domain 03, Flint River, has physical and functional differences from the conventional AIS Buoy model at our AIS lake and river sites. This version of the AIS Buoy contains two Multisonde instruments, a parasitic pump, and different mounts/installations for the uPAR, SUNA and Multisonde sensors. This section addresses an overview of the FLNT AIS Buoy uPAR mount for context and awareness (Figure 23). Because the site is currently under construction, incorporation of additional information to

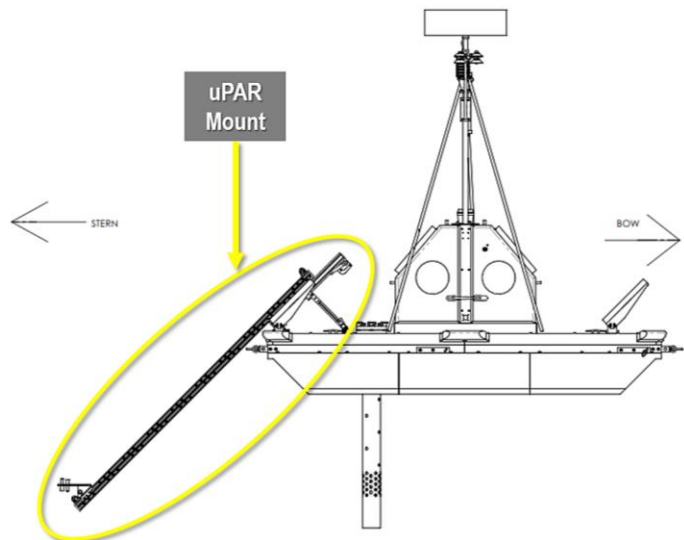

Figure 23. D03 FLNT River | AIS Buoy: uPAR Mount & Placement

Title: NEON Preventive Maintenance Procedure: Underwater Photosynthetically Active Radiation (UPAR)		Date: 2/12/2018
NEON Doc. #: NEON.DOC.002757	Author: D. Monahan, M. Cavileer, G. Simonds	Revision: A

occur in the near future. Reference AD [07] for detail on the AIS Buoy for both AIS lake and river sites.

Table 8 provides an overview of how the uPAR Mount functions on the FLNT AIS Buoy.

Table 8. D03 FLNT River | AIS Buoy: How to Use uPAR Mount



Figure 24. uPAR Mount Winch

STEP 1 | Release the one lock securing the PAR mount underwater (it looks like handles in Figure 25, but on the other side of the mount).

Crank the winch (Figure 24) to lower and raise the uPAR mount above or below water.

Use a dry brush and river water to scrub off debris/biofouling/animal excrement in the mount tracks, etc.



Figure 25. uPAR Mount Locking Mechanism Example

STEP 2 | Use the handles to lock the mechanism above water (an example of one is in Figure 25).

There are five locking mechanisms to secure the mount components above water: four for the components that mount directly off the Buoy and one for the uPAR sensor mount.

Remove each uPAR from the mount by removing three #6-32 screws. (LICOR provides the hardware for the uPAR. 9901-220 Underwater Parts Kit, QTY 2 – 1 for each uPAR.)

STEP 3 | Return to **STEP 6** in Table 7. AIS Buoy uPAR Removal/Reinstallation Procedure.

Title: NEON Preventive Maintenance Procedure: Underwater Photosynthetically Active Radiation (UPAR)		Date: 2/12/2018
NEON Doc. #: NEON.DOC.002757	Author: D. Monahan, M. Cavileer, G. Simonds	Revision: A

6.3 Cleaning & Packaging of Returned Sensor

Field Operations staff clean, package, and ship the sensors back to the CVAL at the NEON project HQ (Battelle Ecology) for annual sensor swap/calibration requirements. (Please note: if a sensor is defective, submit a trouble ticket and affix a red tag with the trouble ticket number on it.) Clean the Grape (also known as decontamination; *Reference* [RD \[03\]](#)) by removing all biologics from the device prior to capping the connections and placing in ESD packaging.

 *Please remove all arachnids and/or insects from tower instruments prior to packing and shipping. Reference [RD \[03\]](#).*

For the cleaning and packaging of Grapes and Sensors post-removal, conduct the following steps:

1. Check mounting holes for spiders and spider webs. Remove biologics and clean connectors.
2. Cap all connectors.
3. Conduct decontamination and remove any additional biologics from the devices. Use a 10% bleach solution for the Grape(s). Reference [RD \[03\]](#) for aquatic sensor decontamination procedures.
4. Pack the devices for shipping/handling.
 - a. Place Uvifera Grape in an ESD bag and shipping container.
 - b. Verify uPAR sensor is decontaminated and has a protective cap over the diffuser.
 - c. Place uPAR sensor in an ESD bag. Ship the sensor back to HQ in the same shipping package CVAL provided for the “refreshed” uPAR sensor.
5. Update asset records via the NEON’s project Asset Management and Logistic Tracking System (e.g., All devices in transit to HQ shall be moved to TRANSIT in Maximo). NEON HQ, Logistics Warehouse (LOGWAR) receives the Grapes for refresh and distributes to CVAL.

 ***Note: In general, to minimize errors for CI, all devices leaving a CFGLOC must move to SITE first, then TRANSIT/DxxSUPPORT.***

6. Provide an electronic packing list to CVAL with the Box number and Asset Tag number (14-digit Property Tag ID (“Property of”) number) of each item. CVAL uses this information to verify items via LOGWAR/general HQ distribution of shipments.
7. Prepare a Bill of Lading.

 ***For any Non-CVAL initiated sensor returns, please notify CVAL of the return.***

For Sensor Refresh, package sensor items via packaging from CVAL HQ with packing list or per guidance via the Issue Management System and return to the NEON project HQ using the following address:

BATTELLE ECOLOGY, ATTN: CVAL

Title: NEON Preventive Maintenance Procedure: Underwater Photosynthetically Active Radiation (UPAR)		Date: 2/12/2018
NEON Doc. #: NEON.DOC.002757	Author: D. Monahan, M. Cavileer, G. Simonds	Revision: A

1685 38TH STREET, SUITE 100
BOULDER, CO 80301

Only include sensors/subsystems for refresh. Additional equipment must ship separately as it may require attention from other NEON HQ departments. Sensor refresh shipments go directly to CVAL. If sensors are shipping to HQ to address a trouble ticket, per guidance via the Issue Management System, return to the NEON project HQ using the following address:

BATTELLE ECOLOGY, **ATTN: REPAIR LAB**
1685 38TH STREET, SUITE 100
BOULDER, CO 80301

6.4 Sensor Refresh Record Management of Assets

In addition to the physical movement of devices, the sensor refresh process requires dedicated and accurate record management of asset movement and location.

6.4.1 NEON Asset Management and Logistic Tracking System Requirements

Technicians must update the instrumentation records via the NEON’s project Asset Management and Logistic Tracking System (MAXIMO). NEON HQ must maintain accurate record keeping on the location, date, and time offline of an instrument to ensure NEON HQ, Computer Infrastructure, Data Products, and CVAL are aware to apply the correct algorithms, calibrations, and processing factors. Ensure the CFG location reflects the current site of the sensor. All devices leaving a CFGLOC must move to SITE first, then TRANSIT/DxxSUPPORT.

Title: NEON Preventive Maintenance Procedure: Underwater Photosynthetically Active Radiation (UPAR)		Date: 2/12/2018
NEON Doc. #: NEON.DOC.002757	Author: D. Monahan, M. Cavileer, G. Simonds	Revision: A

7 ISSUE REPORTING OUTPUTS

FOPS must report issues encountered while conducting preventive maintenance in the NEON project Issue Management/Reporting System. FOPs must report streaming problems encountered during preventive maintenance. To ensure a quick response and remedy to an issue, please include as much information and detail, as possible. This includes, but is not limited, to the following:

- Domain and Site name
- Date and Time
- Technician Full Name
- Issue Narrative (detailed narrative of the issue, specific location of issue on tower infrastructure, relevant 2nd/3rd order effects to infrastructure, possible cause [e.g., weather event, obstruction, human activity])
- Multiple Photographs (to capture vantage points/perspectives for remote diagnostic)
- Provide Part Number/Manufacturer Information, EPROM ID, Asset Tags, IP/MAC Address, etc.
- Provide Diagnostic Information (from firmware, if applicable), such as error codes, values, etc. Provide screenshots.

Table 9. uPAR Sensor Metadata Output Checklist

Issue Reporting Datasheet		
Datasheet field	Entry	
NEON Site Code		
Maintenance Date		
Maintenance Technician		
Preventive Maintenance	Issue Noted	Issue Summary
uPAR Sensor - Configuration Check – Data streams on Network/SAS?	<input type="checkbox"/>	
Site – Condition Check	<input type="checkbox"/>	
Infrastructure - Condition Check	<input type="checkbox"/>	
Inlet/Outlet uPAR – Level?		
Sensor – Condition Check	<input type="checkbox"/>	
Sensor Cables & Connectors - Condition Check	<input type="checkbox"/>	
Environmental Information	<input type="checkbox"/>	
Notes		

Title: NEON Preventive Maintenance Procedure: Underwater Photosynthetically Active Radiation (UPAR)		Date: 2/12/2018
NEON Doc. #: NEON.DOC.002757	Author: D. Monahan, M. Cavileer, G. Simonds	Revision: A

Ship all defective equipment/assets with a red “Rejected” tag. Figure 26 displays the minimum information requirements for each tag.

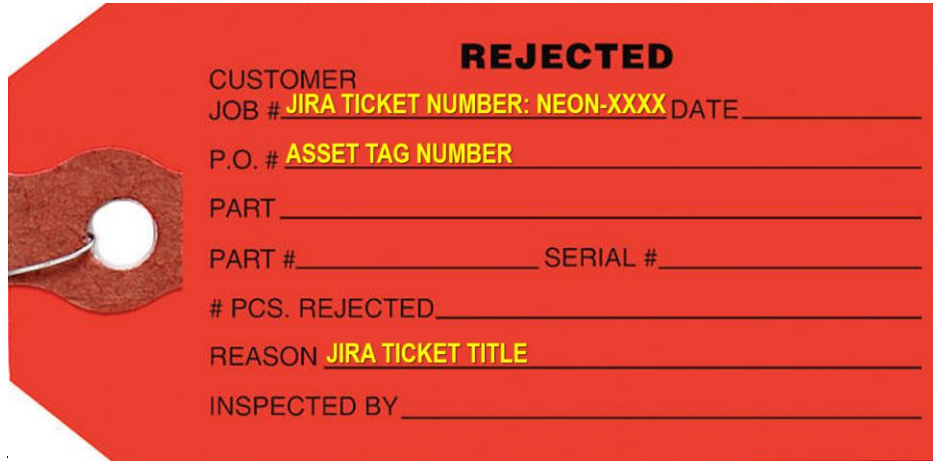

Figure 26. Red Rejected Tag for Defective Assets (MX104219)

Title: NEON Preventive Maintenance Procedure: Underwater Photosynthetically Active Radiation (UPAR)		Date: 2/12/2018
NEON Doc. #: NEON.DOC.002757	Author: D. Monahan, M. Cavileer, G. Simonds	Revision: A

8 INLET/OUTLET WINTERIZATION REQUIREMENTS

This procedure specifically applies to sites that incur winter temperatures that fall below infrastructure environmental thresholds, as applicable (D05, D09, D12, D18, and D19 per NEON.AIS.4.1314). **This is mandatory for sites in Alaska (D18 and D19).** AIS Science is addressing the remaining sites on a case-by-case basis to monitor weather patterns to determine best-case scenario or determine if there is a need to remove the instrument and battery from each inlet/outlet (D05, D09, D13 and D12).

The Domain Manager must use their discretion to determine the most appropriate time to shut down the site as October arrives, and when to start-up in May (per TIS Science guidance for snowpack at D18 TOOL). Follow the AIS Science ice-on/ice-off rule of thumb – remove/shutdown when ice accumulates and reinstall/startup when ice melts. See Table 10 for specific guidance on infrastructure equipment requiring removal from the AIS sites over winter. Reference [AD \[07\]](#) for AIS Buoy winterization requirements.

 *Note: Dates for removal/reinstallation are subject to change as Domains experience and gain additional insight on weather patterns. Track dates using the NEON Project Issue Management and Reporting System.*

Table 10. Inlet/Outlet Sensor and Subsystem Winterization Requirements

Equipment	Environmental Specifications
Solar Charge Controller, 12.8V LiPO4, 65W	Operating Temp: -40°C - 85°C 10 Year Warranty Trickle charge to recover dead battery
Radio Modem, 900 MHz, RS485	Operating Temp: -40°C to 85°C
Battery, LiFePO4, 12.8V 25AH	No need for a trickle charger. Requires charging prior to re-installation. Charge battery pack with specific charger, 0.2 C20A constant Current/constant voltage to 15.2V. Storage Temperature: -10~40°C Best storage temperature for long durations: 20±5°C
Antenna, Omnidirectional	Operating Temp: -40°C to 60°C
Molex Connectors	Non-operating/Operating: - 40°C to + 105°C
Cables	Ice may form on cables that remain onsite. Remove ice from cables when able to access equipment onsite.
Uvifera (12) Grape	The standard Grape operating range is -29°C to 50°C. Testing found Grapes are capable of operating safely from -40°C to 60°C. ^v
uPAR	Operating Temp: -40°C to 65°C
Level TROLL	Operational: -20-80° C (-4-176° F) Storage: -40-80° C (-40-176° F) Calibrated: -5-50° C (23-122° F) Do not deploy instruments in such a way that ice may form on or near the sensors or cable connections. Ice formation is a powerful expansive force that can over-pressurize the sensor or otherwise cause damage that is not covered by the warranty. ^{vi}

8.1 Equipment

Table 11 provides a list of equipment to removal/reinstall the Inlet/Outlet Combo box 12V battery and winterization considerations/maintenance for the uPAR sensor and subsystem.

Table 11. Winterization Equipment Removal Procedure Equipment List

P/N	NEON P/N	Description	Quantity
Tools			
		Flat Bladed Screwdriver or 7/16" wrench or socket(to open Power/Comm boxes)	1
CH-LF12810A	0354920000	AA Portable Power Corp, Smart Charger (designed to charge the GWW LiFePO4 batteries)	1
		Winter Weather Equipment	A/R
Consumable Items			
GENERIC		Packaging (to protect batteries in transit to the Domain)	A/R
		Red Plastic Nipple Caps (in-situ caps that come with assembly)	A/R
GENERIC		Plastic Baggy	A/R
GENERIC		Electrical Tape (rated for -70°C and Rain for covering connectors on the power box & regular tape to cover cables temporarily in storage at DSF)	1-2 Rolls
		ESD Bags	2-4

8.2 Inlet/Outlet Combo Box Battery Removal/Reinstallation Procedure

8.2.1 Remove Inlet/Outlet Combo Box Battery

1. The Ethernet cable from the Inlet/Outlet Combo box to power down the Uvifera (12V) Grape (Figure 27).

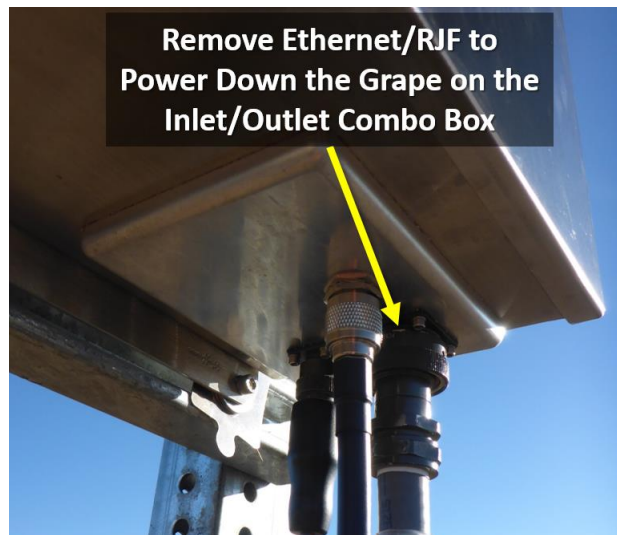
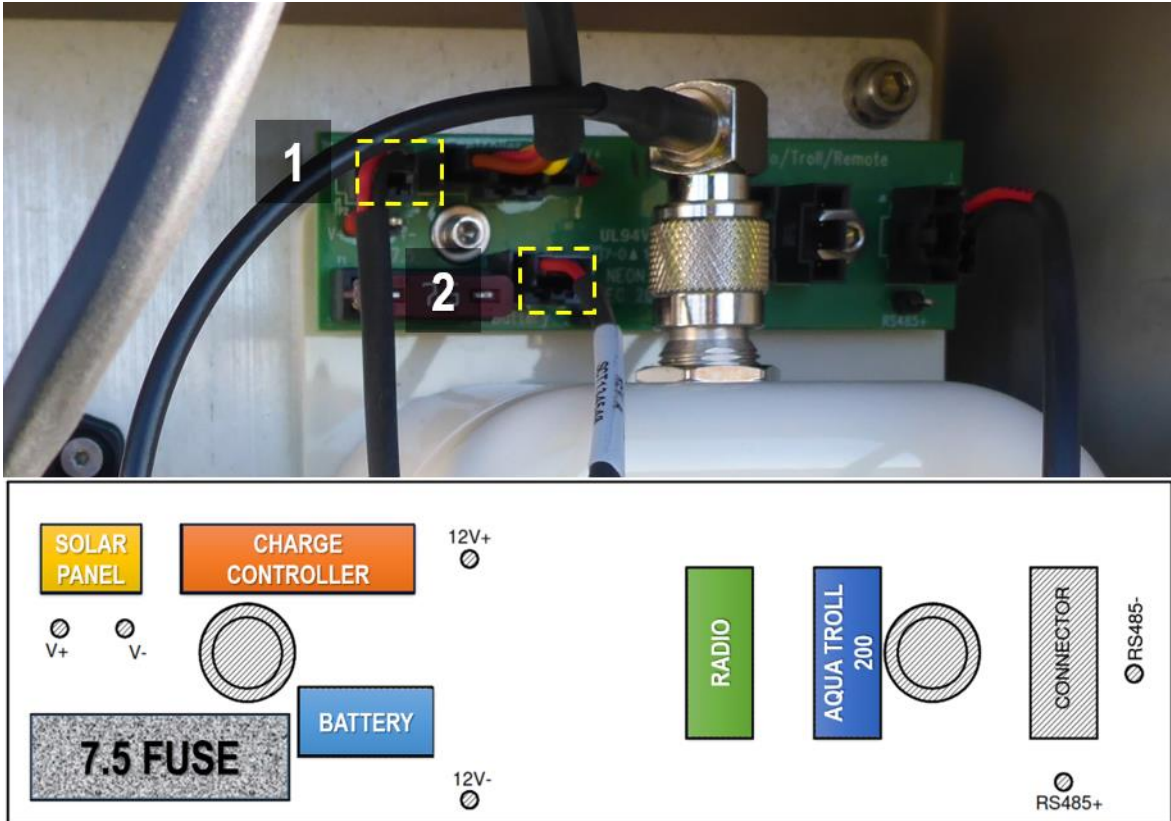

Figure 27. Inlet/Outlet Combo Box

2. Cap the power cable connectors. Use the red nipple caps provided with the assembly or leave the cable connected and hang the cable connector facing using a small plastic bag with electrical tape to act as a rain shield/cap.

Title: NEON Preventive Maintenance Procedure: Underwater Photosynthetically Active Radiation (UPAR)		Date: 2/12/2018
NEON Doc. #: NEON.DOC.002757	Author: D. Monahan, M. Cavileer, G. Simonds	Revision: A

- Open the Inlet/Outlet Comb Box using a Flat Bladed screwdriver or 7/16" wrench or socket.
- Unplug the solar panel and battery connector from the junction board (CB14140000) using Figure 28. **Squeeze the locking tab prior to pulling the cable from the board. Be gentle to prevent un-seating any of the pins in the connectors.**



DRAWN DSTEWART	4/7/2015	 NEON INC. WWW.NEONINC.ORG <small>NATIONAL ECOLOGICAL OBSERVATORY NETWORK</small>
CHECKED LBANTA	4/7/2015	
APPROVED LNEWTON	4/7/2015	
UNLESS OTHERWISE SPECIFIED DIMENSIONS ARE IN INCHES		TITLE AQUA RADIO INTERCONNECT BOARD
UNLESS OTHERWISE SPECIFIED TOLERANCES ARE: X = ± .100 XX = ± .010 XXX = ± .005 ANGLES = ± 1°		SIZE B
ALL DIMENSIONS PER ASME Y14.5 1994		DWG NO CB14140000
		REV A
		SCALE 3:1
		DO NOT SCALE SHEET 1 OF 1

Figure 28. Solar Panel and Battery Connector from the Junction Board (CB14140000)

- Release battery from Velcro strap and place in packaging/bag/box.
- Disconnect radio connector (Figure 29). **Squeeze the locking tab prior to pulling the cable from the board. Be gentle to prevent un-seating any of the pins in the connectors.**

Title: NEON Preventive Maintenance Procedure: Underwater Photosynthetically Active Radiation (UPAR)		Date: 2/12/2018
NEON Doc. #: NEON.DOC.002757	Author: D. Monahan, M. Cavileer, G. Simonds	Revision: A

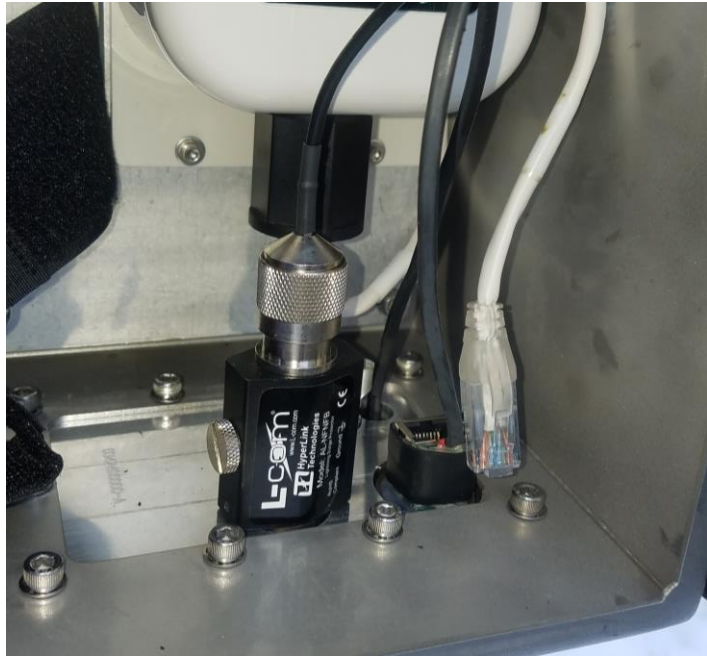



Figure 29. Disconnect Radio Connector (Bottom Right Corner of Combo Box, D18 TOOK)

 Note: Since the NEON project does not presently have specifications for sturdy caps (or as part of the assembly) for the Combo Box, HQ recommends disconnecting components internally, while leaving the cables connected, but capped, to protect the connectors and capping from water intrusion, etc.

7. Close the Inlet/Outlet Comb Box using a screwdriver or 7/16" wrench or socket.
8. Store the batteries in an environmentally controlled storage space/Domain Office.
9. See Table 11 for battery charger information.

8.2.2 Reinstall the Inlet/Outlet Combo Box Battery

1. Verify batteries have a full charge prior to heading to the site. Use the charger or equivalent listed in Table 11 for this step.
2. Open the Inlet/Outlet Comb Box using a screwdriver or 7/16" wrench or socket.
3. Reattach battery in Velcro strap. **WAIT to plug in the battery.**
4. Reinstall Inlet/Outlet instrumentation, disregard if not applicable.
5. Plug in the battery in the upper right hand corner of the NEMA enclosure (see Figure 28 for location). **Only connect the battery when the GWW instruments are in place and connected to the Radio/Power box components.** The solar power system does not have switches to control for power like the alternate power system.
6. Plug in Solar Panel connector to the junction board (CB14140000) using Figure 28.

Title: NEON Preventive Maintenance Procedure: Underwater Photosynthetically Active Radiation (UPAR)		Date: 2/12/2018
NEON Doc. #: NEON.DOC.002757	Author: D. Monahan, M. Cavileer, G. Simonds	Revision: A

7. Plug in the radio connector.
8. Remove plastic caps/bags and reconnect power cables to combo box.
9. Close the Inlet/Outlet Comb Box using a screwdriver or 7/16" wrench or socket.

8.3 uPAR Sensor Removal/Reinstallation Procedure

8.3.1 Remove the uPAR Sensor

Follow the procedure to remove the uPAR sensor(s) in *Section 6.2.2 Inlet/Outlet uPAR Sensor Removal/Replacement Procedure*.

8.3.2 Reinstall the uPAR Sensor

Follow the procedure to reinstall the uPAR sensor(s) in *Section 6.2.2 Inlet/Outlet uPAR Sensor Removal/Replacement Procedure*.

8.4 Winter Maintenance for Operational Sites

For procedures involving ice removal, conduct a JSA to determine if the site is safe to visit and/or conduct the procedures below. FOPS must coordinate with the NEON Safety Office to determine site safety criteria/hazard identification to determine when it is safe to conduct AIS winter preventive maintenance on the equipment.

8.4.1 Equipment

P/N	NEON P/N	Description	Quantity
Tools			
GENERIC		Wooden Dowel (.50 dia x 36" Lg.)	1
GENERIC		Snow Removal Tool/Telescoping Squeegee	1
GENERIC		Winter Weather Equipment, PPE + Gloves	A/R
GENERIC		Hand Warmers (Self-Heating)/Thermos	A/R

8.4.2 Remove Ice from Combo/Key Locks

To remove ice, use self-heating hand warmers or thermos of hot water.

8.4.3 Remove Ice from Cables

Use hands in gloves or a wooden dowel (.50 dia x 36" Lg.) to move the cables only enough to break off ice. **DO NOT HIT THE CABLES.** Brush the snow away from the connectors as much as possible. Break off any hanging icicles, as appropriate (consult with the NEON Safety Office to establish criteria for winter hazard identification or conduct a JSA to determine if the site/icicle is safe to approach). **Do not remove icicles when staff or specific equipment are present below.** A gentle tap with a wooden rod on the icicle base should suffice.

<i>Title:</i> NEON Preventive Maintenance Procedure: Underwater Photosynthetically Active Radiation (UPAR)		<i>Date:</i> 2/12/2018
<i>NEON Doc. #:</i> NEON.DOC.002757	<i>Author:</i> D. Monahan, M. Cavileer, G. Simonds	<i>Revision:</i> A

8.4.4 Remove Snow and/or Ice from Solar Panels

For solar panel winter preventive maintenance, use equipment similar to removing ice from a car windshield (solar panel exterior is tempered glass) or use a specific [snow removal tool](#)/[telescoping squeegee](#). Do not use ethanol; it increases the risk of spills/site contamination. Do not use special window/car treatments for ice - no RainX, rock salt or car wax.

Title: NEON Preventive Maintenance Procedure: Underwater Photosynthetically Active Radiation (UPAR)		Date: 2/12/2018
NEON Doc. #: NEON.DOC.002757	Author: D. Monahan, M. Cavileer, G. Simonds	Revision: A

9 SOURCES

Corell, Stieg, John Staarmann and Corey Huffman. Ice removal from cables for Winter Preventive Maintenance for Operational Sites. December 12, 2017.

Fitzgerald, Michael. UPAR CDR Slides. January 31, 2013. <file:///N:\Common\IPT\00%20Archive-Released%20Designs\1.%20See%20Agile-AIS-Underwater%20PAR\A-Drawings\UPAR%20CDR%20Slides.pptx>

In-Situ, Inc. Level TROLL 400, 500, 700, 700H Model Operators Manual. 0052210 | Rev. 009 | 09/2013. https://in-situ.com/wp-content/uploads/2014/11/Level-TROLL-400-500-700-700h_Manual.pdf

Knapp, Liz and Brandon McLaughlin. Below Water PAR Presentation PPT. June 24, 2015.

Simonds, Geoff. AIS Post I&V Impact Report D18RA1 TOOK. July 20, 2017. <file:///N:\Common\IPT\00%20Archive-Released%20Designs\1.%20See%20Agile-AIS-Underwater%20PAR\A-Drawings\UPAR%20CDR%20Slides.pptx>

Simonds, Geoff. AIS Integration Photos of D03 FLNT Buoy. N:\Common\SYS\Install Docs Work in Progress 20170619\AIS_Install_Docs\Incoming_Drafts\D03-FLNT

Willingham, Rachael. AIS Verification Photos. N:\Common\SYS\Install Docs Work in Progress 20170619\AIS_Install_Docs\Incoming_Drafts\CA1 - Prairie Pothole\PRPO_rwillingham

ⁱ LI-COR, “LI-192 Underwater Quantum Sensor,” <https://www.licor.com/documents/3bjwy50xsb49jqof0wz4>

ⁱⁱ LI-COR, “How does it work?” https://www.licor.com/env/products/light/quantum_underwater.html

ⁱⁱⁱ LI-COR, “LI-192 Underwater Quantum Sensor,” <https://www.licor.com/documents/3bjwy50xsb49jqof0wz4>

^{iv} Also known as a “Sea Grape”. Source: <https://plants.usda.gov/core/profile?symbol=COUV>

^v John Staarmann, RE: Operating/Storage Temps for Uvifera Grape Email, January 10, 2018

^{vi} In-Situ, Inc. “*Cleaning and Maintenance*”, Level TROLL 400, 500, 700, 700H Model Operators Manual, pg. 72 https://in-situ.com/wp-content/uploads/2014/11/Level-TROLL-400-500-700-700h_Manual.pdf