

<i>Title:</i> TOS Protocol and Procedure: Measurement of Vegetation Structure		<i>Date:</i> 10/01/2014
<i>NEON Doc. #:</i> NEON.DOC.000987	<i>Author:</i> C. Meier	<i>Revision:</i> D

TOS PROTOCOL AND PROCEDURE: MEASUREMENT OF VEGETATION STRUCTURE

PREPARED BY	ORGANIZATION	DATE
Courtney Meier	FSU	04/01/2013
Katherine Jones	FSU	04/01/2013

APPROVALS	ORGANIZATION	APPROVAL DATE
Mike Stewart	PSE	09/30/2014
Andrea Thorpe	FSU	09/10/2014
Kirsten Ruiz	FOPS	09/15/2014
Dave Tazik	SCI	09/10/2014

RELEASED BY	ORGANIZATION	RELEASE DATE
Stephen Craft	PSE	10/01/2014

See configuration management system for approval history.

© 2014 NEON Inc. All rights reserved.

<i>Title:</i> TOS Protocol and Procedure: Measurement of Vegetation Structure		<i>Date:</i> 10/01/2014
<i>NEON Doc. #:</i> NEON.DOC.000987	<i>Author:</i> C. Meier	<i>Revision:</i> D

Change Record

REVISION	DATE	ECO #	DESCRIPTION OF CHANGE
A	01/10/2014	ECO-01139	Initial release
B	03/20/2014	ECO-01661	Production release, template change, and other changes as detailed in Appendix C (rev B only)
C	04/10/2014	ECO-01792	Added Appendix H with site-specific information
D	10/01/2014	ECO-02287	Migration to new protocol template

Title: TOS Protocol and Procedure: Measurement of Vegetation Structure		Date: 10/01/2014
NEON Doc. #: NEON.DOC.000987	Author: C. Meier	Revision: D

TABLE OF CONTENTS

1 OVERVIEW1

1.1 Background 1

1.2 Scope..... 1

1.2.1 NEON Science Requirements and Data Products 1

1.3 Acknowledgments..... 2

2 RELATED DOCUMENTS AND ACRONYMS2

2.1 Applicable Documents 2

2.2 Reference Documents..... 2

2.3 Acronyms 3

2.4 Definitions..... 3

3 METHOD4

4 SAMPLING SCHEDULE6

4.1 Sampling Frequency and Timing 6

4.1.1 Distributed Plots 7

4.1.2 Tower Plots 7

4.2 Criteria for Determining Onset and Cessation of Sampling..... 7

4.2.1 Sites with Distinct Growing Seasons 7

4.2.2 Sites with No Distinct Growing Season 7

4.3 Sampling Timing Contingencies 8

5 SAFETY9

6 PERSONNEL AND EQUIPMENT.....10

6.1 Equipment..... 10

6.2 Training Requirements..... 20

6.3 Specialized Skills..... 20

6.4 Estimated Time 20

7 STANDARD OPERATING PROCEDURES21

SOP A PREPARING FOR SAMPLING22

SOP B DEFINING VEGETATION CLASSIFICATION23

SOP C MAPPING AND TAGGING26

Title: TOS Protocol and Procedure: Measurement of Vegetation Structure		Date: 10/01/2014
NEON Doc. #: NEON.DOC.000987	Author: C. Meier	Revision: D

SOP D BIOMASS/PRODUCTIVITY MEASUREMENTS30

SOP E FIELD CAMPAIGN FOLLOW-UP42

SOP F DATA ENTRY AND VERIFICATION43

SOP G SAMPLE SHIPMENT44

8 REFERENCES45

APPENDIX A DATASHEETS46

APPENDIX B QUICK REFERENCES47

APPENDIX C REMINDERS49

APPENDIX D USING AND CALIBRATING THE TRUPULSE 360R50

APPENDIX E “OTHER” NON-WOODY, NON-HERBACEOUS VEGETATION58

APPENDIX F SAFE HANDLING AND MEASUREMENT OF *TOXICODENDRON* SPECIES59

APPENDIX G PLOT MAP60

APPENDIX H ESTIMATED DATES FOR ONSET AND CESSATION OF SAMPLING61

Title: TOS Protocol and Procedure: Measurement of Vegetation Structure		Date: 10/01/2014
NEON Doc. #: NEON.DOC.000987	Author: C. Meier	Revision: D

LIST OF TABLES AND FIGURES

Table 1. Contingent decisions..... 8

Table 2. Equipment list – Preparing for Sampling 10

Table 3. Equipment list – Mapping and Tagging..... 11

Table 4. Equipment list – Biomass/productivity measurements* 15

Table 5. Equipment and materials required to minimize exposure to oils from *Toxicodendron spp.* 19

Table 6. Summary of biomass measurements required for each growth form 24

Table 7. identificationQualifier codes for species ID 27

Table 8. Tag placement and method for each veg classification..... 29

Table 9. Rules for determining the appropriate DBH measurement location 34

Table 10. Stem Status value definitions 37

Table 11. Canopy position definitions 38

Table 12. Shrub shapes for volume estimates..... 39

Table 13. Datasheets associated with this protocol..... 46

Table 14. Site-specific sampling start and end dates for vegetation structure measurements..... 61

Table 15. Day-of-year calendar for non-leap years 65

Figure 1. Generalized TOS sampling schematic..... 5

Figure 2. Illustration of a 20 m × 20 m Distributed/Gradient base plot 5

Figure 3. Decision tree for defining growth forms 23

Figure 4. Point IDs for NEON plots of varying sizes 28

Figure 5. Situations that determine the location at which liana DBH should be measured 34

Figure 6. Graph paper method for determining shrub group area within a 10 m x 10 m subplot 40

Figure 7. TruPulse 360R viewfinder showing a user-entered declination value 50

Figure 8. TruPulse 360R viewfinder when initiating the tilt-sensor calibration routine 51

Figure 9. TruPulse 360R tilt-sensor calibration routine..... 52

Figure 10. TruPulse 360R viewfinder during compass calibration procedure..... 53

Figure 11. TruPulse 360R compass calibration routine 54

Figure 12. Plot map..... 60

Title: TOS Protocol and Procedure: Measurement of Vegetation Structure		Date: 10/01/2014
NEON Doc. #: NEON.DOC.000987	Author: C. Meier	Revision: D

1 OVERVIEW

1.1 Background

The measurement of vegetation structure, as well as the mapping of free-standing woody stems, is an important complement to data streams generated by the NEON AOP and TIS. These ground-collected data will validate LiDAR data used to map the structural complexity of vegetation, will enable mapping of plant biomass at the site scale, and in conjunction with carbon flux data, will facilitate understanding how biomass in different plant growth forms contributes to ecosystem level carbon flux.

This protocol is designed to measure key aspects of vegetation structure that are directly analogous to airborne LiDAR observations, as well as additional structural metrics that enable estimation of per stem and per plot plant biomass and productivity. These measurements include: stem diameter(s), canopy diameter(s), stem height, stem location (for stems that meet certain criteria), stem species identification, and stem status (i.e. healthy, dead, or damaged).

There are numerous methods for measuring and mapping woody stems, and the recommended procedure depends greatly on the amount of labor and time available to complete the work, the equipment budget, ecosystem type, and on the scientific requirements associated with geo-registration of ground-data with approximately 1 m²-resolution airborne remote-sensing datasets. The overarching goal of this protocol is to utilize methods that are robust across a wide-variety of field conditions and ecosystem types, are relatively easy to implement in the field, are not prone to user error, and that are capable of producing high-quality data.

1.2 Scope

This document provides a change-controlled version of Observatory protocols and procedures. Documentation of content changes (i.e. changes in particular tasks or safety practices) will occur via this change-controlled document, not through field manuals or training materials.

1.2.1 NEON Science Requirements and Data Products

This protocol fulfills Observatory science requirements that reside in NEON's Dynamic Object-Oriented Requirements System (DOORS). Copies of approved science requirements have been exported from DOORS and are available in NEON's document repository, or upon request.

Execution of this protocol procures samples and/or generates raw data satisfying NEON Observatory scientific requirements. These data and samples are used to create NEON data products, and are documented in the NEON Scientific Data Products Catalog (RD[03]).

Title: TOS Protocol and Procedure: Measurement of Vegetation Structure		Date: 10/01/2014
NEON Doc. #: NEON.DOC.000987	Author: C. Meier	Revision: D

1.3 Acknowledgments

Benjamin Chemel with the Northern Rockies Conservation Cooperative contributed substantially the initial development and testing of this protocol.

2 RELATED DOCUMENTS AND ACRONYMS

2.1 Applicable Documents

Applicable documents contain higher-level information that is implemented in the current document. Examples include designs, plans, or standards.

AD[01]	NEON.DOC.004300	EHS Safety Policy and Program Manual
AD[02]	NEON.DOC.004316	Operations Field Safety and Security Plan
AD[03]	NEON.DOC.000724	Domain Chemical Hygiene Plan and Biosafety Manual
AD[04]	NEON.DOC.001155	NEON Training Plan
AD[05]	NEON.DOC.050005	Field Operations Job Instruction Training Plan
AD[06]	NEON.DOC.000914	NEON Science Design for Plant Biomass, Productivity, and Leaf Area Index
AD[07]	NEON.DOC.014051	Field Audit Plan
AD[08]	NEON.DOC.000824	Data and Data Product Quality Assurance and Control Plan

2.2 Reference Documents

Reference documents contain information that supports or complements the current document. Examples include related protocols, datasheets, or general-information references.

RD[01]	NEON.DOC.000008	NEON Acronym List
RD[02]	NEON.DOC.000243	NEON Glossary of Terms
RD[03]	NEON.DOC.005003	NEON Scientific Data Products Catalog
RD[04]	NEON.DOC.001271	TOS Protocol and Procedure: Manual Data Transcription
RD[05]	NEON.DOC.001573	Datasheets for TOS Protocol and Procedure: Measurement of Vegetation Structure
RD[06]	NEON.DOC.014037	TOS Protocol and Procedure: Measurement of Herbaceous Structure and Biomass
RD[07]	NEON.DOC.014042	TOS Protocol and Procedure: Plant Diversity Sampling
RD[08]	NEON.DOC.001025	TOS Protocol and Procedure: Plot Establishment

Title: TOS Protocol and Procedure: Measurement of Vegetation Structure		Date: 10/01/2014
NEON Doc. #: NEON.DOC.000987	Author: C. Meier	Revision: D

2.3 Acronyms

Acronym	Definition
BH	Breast height
DBH	Diameter at breast height; breast height = 130 cm above the ground
ddh	Diameter at decimeter height
ha	Hectare(s)
LAI	Leaf Area Index
LiDAR	Light Detection and Ranging
NEE	Net Ecosystem Exchange
NEP	Net Ecosystem Productivity
NPP	Net Primary Productivity

2.4 Definitions

We define trees, saplings/shrubs, and lianas according to the following criteria (see AD[06] for more details):

Trees (single or multi-bole): Self-supporting woody stems with diameter at breast height (DBH) ≥ 10 cm. Individuals are typically, but not always, species that are potential canopy emergents, i.e. individuals that contribute to the topmost overstory layer of forest. Individuals classified as trees are mapped as points within plots.

Small trees and Saplings: Self-supporting woody stems with $1 \text{ cm} < \text{DBH} / \text{ddh} < 10 \text{ cm}$ and a single main stem. Individuals are generally not mapped unless there is no overstory and individuals would be visible from the Airborne Observation Platform (AOP)

Shrubs: Self-supporting woody stems with $\text{DBH} / \text{ddh} < 10 \text{ cm}$ and multiple main stems. Woody stems with no stems $> 1 \text{ cm}$ diameter at decimeter height will be measured as part of the herbaceous plant sampling effort. Individuals may or may not be species that are canopy emergents. Shrubs may be mapped as either points or polygons within plots, depending on whether individuals are isolated or grouped.

Grouped Individuals are defined as two or more individuals in contact, such that it is difficult to discern “individuals”. The word individual here refers to “apparent” individuals, not “genetic” individuals.

Lianas: Non-self-supporting woody stems with $\text{DBH} \geq 1 \text{ cm}$. Lianas are not mapped, but the ID number of the tagged, mapped support tree is recorded during the data collection process.

<i>Title:</i> TOS Protocol and Procedure: Measurement of Vegetation Structure		<i>Date:</i> 10/01/2014
<i>NEON Doc. #:</i> NEON.DOC.000987	<i>Author:</i> C. Meier	<i>Revision:</i> D

3 METHOD

A combination of NEON Distributed, Gradient, and Tower Plots will be used for collecting vegetation structure data (Figure 1 and Figure 2). These ground datasets will enable calibration and validation of annually generated LiDAR datasets, and in conjunction with the AOP data, will form the basis for LiDAR-derived data products at the site and regional scales (e.g. site and regional LAI and plant biomass estimates).

In forested systems, vegetation structure data collected in the Tower Plots will constitute an important component of biomass and productivity estimation within the NEON Tower footprint, and will allow researchers to understand how tower-based NEE and NEP measurements correspond with field-based assessment of NPP. Because field-collected vegetation structure data are integrated with other measurement platforms (i.e. the NEON AOP and TIS), it is very important that the mapping and measurement of woody stems is performed with care, and in a repeatable fashion.

This field procedure is designed to generate data that elucidate the structure, spatial location, and biomass of the woody-stemmed plant community, including tree, sapling/shrub, liana, and other growth forms. Stem mapping activities and the collection of vegetation structure data will take place in Distributed and Tower Plots, and may also take place in Gradient Plots if Gradient Plots are required at a given site. If required, Gradient Plot sampling will not take place until the field season after the first AOP overflight of a site has occurred. The procedure provides detailed guidelines for measuring the following key parameters: diameter at breast height (DBH), diameter at decimeter height (ddh), total stem height, canopy diameter, species ID, stem status (i.e. healthy, snag, damaged, etc.), and the location of measured stems. Parameters such as DBH, ddh, canopy diameter and total stem height can then be used to estimate aboveground biomass and carbon (C) density values, on both a per stem and a per unit area basis.

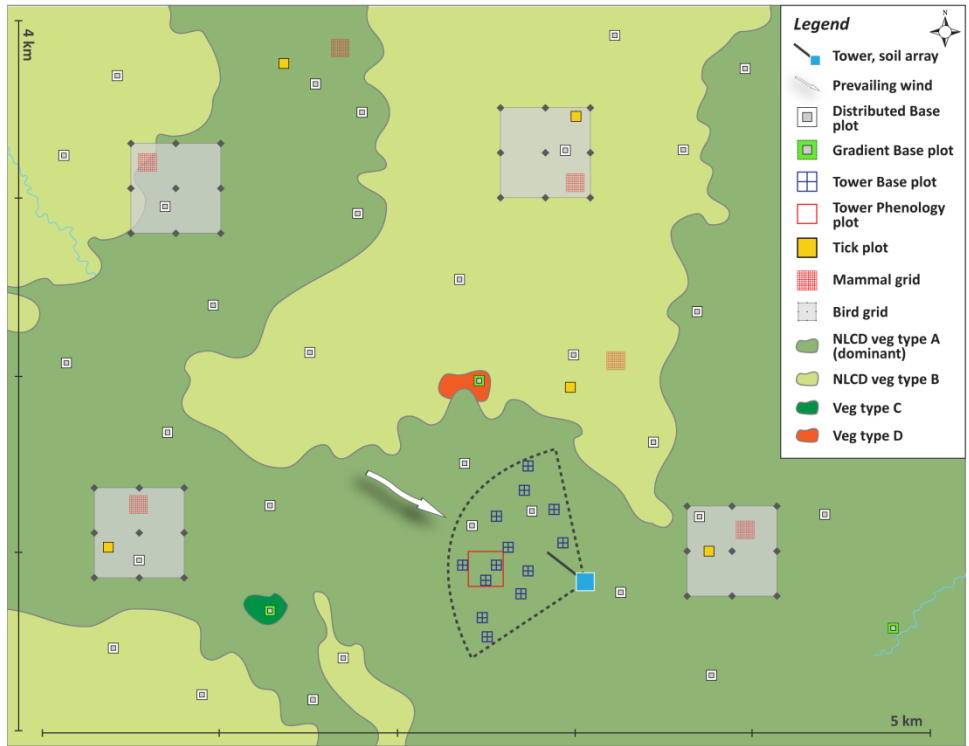

Figure 1. Generalized TOS sampling schematic, showing the placement of Distributed, Tower, and Gradient Plots

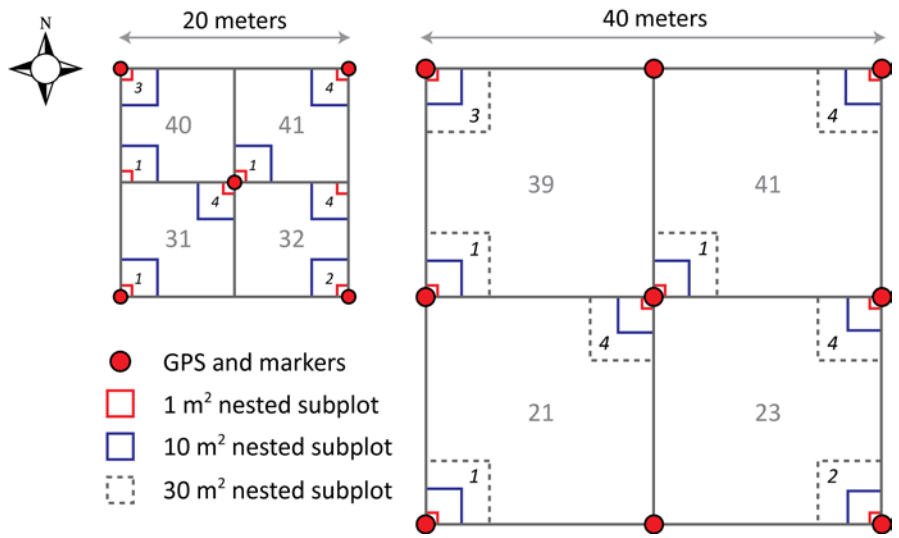

Figure 2. Illustration of a 20 m x 20 m Distributed/Gradient base plot (left), a 40 m x 40 m Tower base plot (right), and associated nested subplots used for measuring woody stem vegetation. Locations of subplots are numbered in plain grey text, and locations of nested subplots are numbered with italic black text

<i>Title:</i> TOS Protocol and Procedure: Measurement of Vegetation Structure		<i>Date:</i> 10/01/2014
<i>NEON Doc. #:</i> NEON.DOC.000987	<i>Author:</i> C. Meier	<i>Revision:</i> D

Additional structure and percent cover measurements will be made on herbaceous plants. These measurements are described in RD[06] and RD[07], respectively. All of the data collected according to this protocol are acquired with hand-held tools in the field, and there is no laboratory component to the work.

Standard Operating Procedures (SOPs), in Section 7 of this document, provide detailed step-by-step directions, contingency plans, sampling tips, and best practices for implementing this sampling procedure. To properly collect and process samples, field technicians **must** follow the protocol and associated SOPs. Use NEON’s problem reporting system to resolve any field issues associated with implementing this protocol.

The value of NEON data hinges on consistent implementation of this protocol across all NEON domains, for the life of the project. It is therefore essential that field personnel carry out this protocol as outlined in this document. In the event that local conditions create uncertainty about carrying out these steps, it is critical that technicians document the problem and enter it in NEON’s problem tracking system.

The procedures described in this protocol will be audited according to the Field Audit Plan (AD[07]). Additional quality assurance will be performed on data collected via these procedures according to the NEON Data and Data Product Quality Assurance and Control Plan (AD[08]).

A combination of hot, cold, and blind checks may be used to ensure that equipment is used properly in the field, that measurements are repeatedly taken from the same locations on individual stems, and that data are recorded and reported according to established guidelines on which technicians have been trained.

4 SAMPLING SCHEDULE

4.1 Sampling Frequency and Timing

The initial timing of sampling onset will be determined by Field Operations staff in each domain and is not constrained to the growing season except to the extent that individuals may be identified to species. Once a sampling onset date has been selected for vegetation structure measurements at a given site by Field Operations, the onset of sampling in subsequent years should be consistent – i.e. within ± 2 weeks. Measurement of woody stemmed individuals (i.e. trees, shrubs) does not have to occur coincident with measurement of species classified as ‘other’ (i.e. ferns, cacti) if conditions are not conducive to sampling these growth forms (e.g. understory ferns are buried by snow).

At each site, sampling for trees, saplings/shrubs, and lianas should take place no more than once per year.

Title: TOS Protocol and Procedure: Measurement of Vegetation Structure		Date: 10/01/2014
NEON Doc. #: NEON.DOC.000987	Author: C. Meier	Revision: D

4.1.1 Distributed Plots

Woody stems in Distributed Plots should ideally be surveyed annually in order to map, tag, and measure individuals recruited into the minimum size class (based on DBH cutoffs), as well as re-measure previously mapped and tagged individuals. If logistical and budgetary constraints arise, Distributed Plots should be sampled according to a site-specific prioritized list provided by Science Operations.

4.1.2 Tower Plots

Woody stems in Tower Plots should be surveyed annually in order to map, tag, and measure individuals recruited into the minimum size class, as well as re-measure previously mapped and tagged individuals.

4.2 Criteria for Determining Onset and Cessation of Sampling

Following the end of a given growing season, measurement of woody stem vegetation structure must be completed before the onset of the next growing season. As a benchmark, it required 4 weeks for a team of two skilled foresters to perform plot establishment and obtain initial vegetation structure measurements from a total Tower Plot area of 3 ha at the D01 Harvard Forest site (n=30 plots of 0.1 ha each). Subsequent measurements should be more rapid than this initial effort, due to these factors: 1) plot-establishment will not be required, 2) the majority of stems in a plot will not require identification to species and tagging, and 3) the majority of stems will already have been mapped in the first sampling year.

At each site, the onset of sampling should be the same date for trees, saplings/shrubs, and lianas. That is, all growth forms should be measured at a given plot when that plot is sampled; technicians should **not** sample trees in all plots first, then re-sample plots for saplings/shrubs and lianas.

4.2.1 Sites with Distinct Growing Seasons

Structural measurements of woody stems should be made after annual growth in a given growing season has completed. For example, in a temperate forest, structural data should be collected any time between late autumn (post-senescence) and early the following spring (prior to leaf/needle expansion). At sites with pronounced wet/dry seasonality – e.g. D17 San Joaquin – structural data should be collected during the dry season when annual growth is minimal.

Once flux data indicate CO₂ source/sink transition dates for each site, Science Operations can provide more precise sampling windows on a site-by-site basis in an additional appendix to this protocol.

4.2.2 Sites with No Distinct Growing Season

For sites with no distinct growing season, sampling should begin at the same time every year \pm 2 weeks. As above, once flux data are available at each site, Science Operations can provide more precise sampling windows on a site-by-site basis in an appendix to this protocol.

Title: TOS Protocol and Procedure: Measurement of Vegetation Structure		Date: 10/01/2014
NEON Doc. #: NEON.DOC.000987	Author: C. Meier	Revision: D

4.3 Sampling Timing Contingencies

When unexpected field conditions require deviations from this protocol, the guidance below must be followed to ensure that basic data quality standards are met:

Table 1. Contingent decisions

Delay/Situation	Action	Outcome for Data Products
Hours to 4 weeks	If delay prevents completion of measuring/mapping a plot or sub-plot, use flagging to ensure it is clear which stems have been measured/mapped and resume data collection from the plot or sub-plot ASAP.	None
	If delay occurs between plots or sub-plots, resume data collection from the next plot or sub-plot ASAP.	None
4 or more weeks	If delay prevents completion of measuring/mapping a plot or sub-plot, use flagging to ensure it is clear which stems have been measured/mapped and resume data collection from the plot or sub-plot ASAP.	Increased error in aboveground biomass and NPP estimates. Temporary flagging may be lost, causing duplicate measurements of individuals; significant wood growth could occur in fast-growing species.
	If delay occurs between plots or sub-plots, resume data collection from the next plot or sub-plot ASAP.	Increased error in aboveground biomass and NPP estimates. Significant wood growth could occur in fast-growing species.

<i>Title:</i> TOS Protocol and Procedure: Measurement of Vegetation Structure		<i>Date:</i> 10/01/2014
<i>NEON Doc. #:</i> NEON.DOC.000987	<i>Author:</i> C. Meier	<i>Revision:</i> D

5 SAFETY

This document identifies procedure-specific safety hazards and associated safety requirements. It does not describe general safety practices or site-specific safety practices.

Personnel working at a NEON site must be compliant with safe field work practices as outlined in the Operations Field Safety and Security Plan (AD[02]) and EHS Safety Policy and Program Manual (AD[01]). Additional safety issues associated with this field procedure are outlined below. The Field Operations Manager and the Lead Field Technician have primary authority to stop work activities based on unsafe field conditions; however, all employees have the responsibility and right to stop their work in unsafe conditions.

A laser rangefinder/hypsometer/compass instrument is used to map individual woody stems as points, and to measure various stem structural attributes. Safety considerations for this instrument include:

- Avoid staring directly at the laser beam for prolonged periods. The rangefinder is classified as eye-safe to Class 1 limits, which means that virtually no hazard is associated with directly viewing the laser output under normal conditions. As with any laser device, however, reasonable precautions should be taken in its operation. It is recommended that you avoid staring into the transmit aperture while firing the laser.

Never attempt to view the sun through the scope. Looking at the sun through the scope may permanently damage the eyes.

Title: TOS Protocol and Procedure: Measurement of Vegetation Structure		Date: 10/01/2014
NEON Doc. #: NEON.DOC.000987	Author: C. Meier	Revision: D

6 PERSONNEL AND EQUIPMENT

A team of two field technicians is required for measuring and mapping woody stems, and identifying stems to species.

6.1 Equipment

The following equipment is needed to implement the procedures in this document. Equipment lists are organized by task. They do not include standard field and laboratory supplies such as charging stations, first aid kits, drying ovens, ultra-low refrigerators, etc.

Table 2. Equipment list – Preparing for Sampling

Item No.	R/S	Description	Purpose	Conditions Used	Quantity	Special Handling
Durable Items						
	R	GPS unit	Locate plots and plot markers	All	1	N
MX100322	R	TruPulse 360R	Map relative stem location; measure stem height, canopy diameters.	Mapping; measuring stems > 2 m height	1	N
	R	USB Cable	Transfer data to GPS unit.	All	1	N
Consumable Items						
(none)						

R/S=Required/Suggested

Title: TOS Protocol and Procedure: Measurement of Vegetation Structure		Date: 10/01/2014
NEON Doc. #: NEON.DOC.000987	Author: C. Meier	Revision: D

Table 3. Equipment list – Mapping and Tagging

Item No.	R/S	Description	Purpose	Conditions Used	Quantity	Special Handling
Durable Items						
	S	GPS unit	Locate plots, subplots, points	All	1	N
MX100322	R	TruPulse 360R	Nested subplot delineation, stem mapping, height and canopy diameter measurement	Sites with woody stems; plots with slopes > 10%	1	N
MX103218	R	Filter, Foliage, For Use With TruPulse 360R; Laser Technology or Equivalent.	Allows use of TruPulse in dense vegetation	Thick, brushy understory	1	N
	R	Extra battery for TruPulse (CR123A type; rechargeables are available if desired)	Backup power	When TruPulse is used	2	N
	R	Non-magnetic tripod with non-magnetic ¼" x 20 ball mount	Hold TruPulse directly over plot marker, eliminate magnetic interference with TruPulse compass.	When TruPulse is used	1	N
	S	Mirror-site compass, declination adjusted	Nested subplot delineation	All	1	N
	S	4" x 5" survey flags; PVC stakes preferred, but metal stakes may be required if soils are compacted	Nested subplot, subplot delineation	All	12	N

Title: TOS Protocol and Procedure: Measurement of Vegetation Structure		Date: 10/01/2014
NEON Doc. #: NEON.DOC.000987	Author: C. Meier	Revision: D

Item No.	R/S	Description	Purpose	Conditions Used	Quantity	Special Handling
	R	Chaining pins	Nested subplot, subplot delineation, guides tape	All	4	N
	S	Tree ID books and/or local flora key	Species identification	All	1	N
	R	Fiberglass tape, 50 m or longer	Nested subplot, subplot delineation	All	2	N
MX106348	R	Lufkin 64 cm DBH tape (not required if woody stems are all less than 5 cm DBH at a given site)	Measure stem diameter.	Stems present with 5 cm < diameter < 64 cm	1	N
	R	Lufkin DBH tape for trees with DBH > 64 cm	Measure stem diameter	Stems present with diameter > 64 cm	1	N
	R	Digital caliper	Measure stem diameter	Stems present with diameter < 5 cm; not required otherwise	1	N
	R	Reflective surface (3" bicycle reflector or reflective tape on back of field notebook)	Used with TruPulse in "Filter" mode to ensure accurate distance measurements.	When TruPulse is used for stem mapping, measuring canopy diameter	1	N
	S	Brightly colored flagging, spool type	Temporary marking of stems to track progress.	All	2	N

Title: TOS Protocol and Procedure: Measurement of Vegetation Structure		Date: 10/01/2014
NEON Doc. #: NEON.DOC.000987	Author: C. Meier	Revision: D

Item No.	R/S	Description	Purpose	Conditions Used	Quantity	Special Handling
	R	Wire cutters	Cut aluminum wire lengths.	When wire is used to attach tags to stems	1	N
	R	Hand stamp steel die set (for labeling blank aluminum tags)	Mark custom tags on multi-stem individuals.	When tags are required to track individuals	1 set	N
	R	Hammer (for labeling blank aluminum tags)	Mark custom tags on multi-stem individuals.	When tags are required to track individuals	1	N
	R	Markal Fluorescent Lumber Crayon	Mark measurement location for stem diameter measurements.	When woody stems are present	1	N
	S	Ice Pack, for cooler	Store voucher specimens of unknown species for later ID	All	As needed	N
	S	Cooler, for unknown plant specimens	Store voucher specimens of unknown species for later ID	All	1	N
	S	Standard plant press, wood frame, 12 x 18 in, with straps	Properly handle voucher specimens for later ID	All	As needed	N
	S	Standard Driers for Plant Press, Blotting Paper, 12 in. x 18 in., White	Properly handle voucher specimens for later ID	All	As needed	N

Title: TOS Protocol and Procedure: Measurement of Vegetation Structure		Date: 10/01/2014
NEON Doc. #: NEON.DOC.000987	Author: C. Meier	Revision: D

Item No.	R/S	Description	Purpose	Conditions Used	Quantity	Special Handling
Consumable Items						
	R	Paper, Copy, All Weather, 8-1/2 inches W x 11 inches L, White; Rite in the Rain or Equivalent.	Data recording	All	As needed	N
MX103478 MX103477	R	Numbered aluminum tags; tag #s 1-1000 are first MX number, tag #s 1001-2000 are second MX number. Higher number ranges commercially available if needed.	Assign a tagID to individual plants.	When tags are required to track individuals.	100	N
MX103481	R	Un-numbered, blank aluminum tags (for marking multi-stemmed individuals)	Custom tags for multi-stemmed individuals.	When tags are required to track individuals	50	N
MX103224	R	Aluminum nails (for affixing tags to those stems with DBH ≥ 5 cm)	Attach tags to stems with DBH ≥ 5 cm.	When tags are required to track individuals	100	N
MX105666	R	Aluminum wire, spool (for fixing tags to stems with DBH < 5 cm)	Attach tags to stems with DBH < 5 cm.	When tags are required to track individuals	1	N
	S	Clear plastic bags for plant voucher collection	Store voucher specimens of unknown species for later ID	All	20	N

R/S=Required/Suggested

Title: TOS Protocol and Procedure: Measurement of Vegetation Structure		Date: 10/01/2014
NEON Doc. #: NEON.DOC.000987	Author: C. Meier	Revision: D

Table 4. Equipment list – Biomass/productivity measurements*

Item No.	R/S	Description	Purpose	Conditions Used	Quantity	Special Handling
Durable Items						
	S	GPS unit, pre-loaded with plot locations.	Navigate to plots/subplots.	All	1	N
MX100322	R	TruPulse 360R laser rangefinder, with current declination entered	For mapping stems recruited into the minimum size class	All	1	N
MX103218	R	Foliage filter for laser rangefinder	Facilitates use of TruPulse in very brushy conditions	Brushy, dense vegetation	1	N
	R	Extra battery for TruPulse (CR123A type; rechargeables are available if desired)	Backup power for TruPulse	All	2	N
	R	Chaining pins	Subplot, nested subplot delineation	All	4	N
	S	Tree ID books and/or local flora key	Aids in identification of unknown species	All	1	N
	R	Fiberglass tape, 50 m or longer	Subplot, nested subplot delineation	All	2	N
MX106348	R	Lufkin 64 cm DBH tape (not required if woody stems are all less than 5 cm DBH at a given site)	Measure stem diameter	Stems present with 5 cm < diameter < 64 cm	1	N

Title: TOS Protocol and Procedure: Measurement of Vegetation Structure		Date: 10/01/2014
NEON Doc. #: NEON.DOC.000987	Author: C. Meier	Revision: D

Item No.	R/S	Description	Purpose	Conditions Used	Quantity	Special Handling
	R	Lufkin DBH tape for trees with DBH > 64 cm	Measure stem diameter	Stems present with diameter > 64 cm	1	N
	R	Digital caliper	Required to measure stem diameters < 5 cm	Stems present with diameter < 5 cm	1	N
	S	Reflective surface (3" bicycle reflector or reflective tape on back of field notebook)	Reflective target for laser rangefinder; aids in measuring distance to target accurately.	All	1	N
	R	Rite-in-the-Rain datasheets or electronic data collection device	Record data	All	As needed	N
	R	QA/QC datasheets or electronic data collection device	Record data	All	As needed	N
	R	Mechanical pencils	Record data	Paper datasheets	3	N
	R	Wire cutters	Cutting aluminum wire	Stems present with DBH < 5 cm	1	N
	R	Hand stamp steel die set	For labeling blank aluminum tags	Multi-stem trees present	1 set	N
	R	Hammer	For labeling blank aluminum tags	Multi-stem trees present	1	N

Title: TOS Protocol and Procedure: Measurement of Vegetation Structure		Date: 10/01/2014
NEON Doc. #: NEON.DOC.000987	Author: C. Meier	Revision: D

Item No.	R/S	Description	Purpose	Conditions Used	Quantity	Special Handling
	R	Markal Fluorescent Lumber Crayon	Marking stem diameter measurement location	All	1	N
	S	Ice Pack, for cooler	Keep voucher specimens of unknowns preserved for ID	All	As needed	N
	S	Cooler	Keep voucher specimens of unknowns preserved for ID	All	1	N
	S	Standard plant press, wood frame, 12 x 18 in, with straps	Keep voucher specimens of unknowns preserved for ID	All	1	N
	S	Standard Driers for Plant Press, Blotting Paper, 12 in. x 18 in., White	Keep voucher specimens of unknowns preserved for ID	All	As needed	N
Consumable Items						
	S	4" x 5" survey flags; PVC stakes preferred, but metal stakes may be required when soils are heavily compacted	Subplot, nested subplot delineation; PVC stakes do not interfere with TruPulse compass.	All	12	N
	S	Brightly colored flagging, spool type	Track stem progress during sampling bout	All	2	N
MX103478 MX103477	R	Numbered aluminum tags	For tagging new individuals that meet minimum size cutoff	All	100	N

Title: TOS Protocol and Procedure: Measurement of Vegetation Structure		Date: 10/01/2014
NEON Doc. #: NEON.DOC.000987	Author: C. Meier	Revision: D

Item No.	R/S	Description	Purpose	Conditions Used	Quantity	Special Handling
MX103481	R	Un-numbered, blank aluminum tags	For marking multi-stemmed individuals	Multi-stem trees present	50	N
	R	Aluminum nails	For affixing tags to stems with DBH \geq 5 cm	Stems present with DBH > 5 cm	100	N
	R	Aluminum wire, spool (0.064 inch diameter)	For fixing tags to stems with DBH < 5 cm	Stems present with DBH < 5 cm	1	N
	S	Graph paper, 1 cm ² grid cells	Estimating area of shrub groups	Shrub groups are present	As needed	N

* Note that much of this equipment will only be used if tags must be replaced or individuals graduate in to minimum class size.

R/S=Required/Suggested

Title: TOS Protocol and Procedure: Measurement of Vegetation Structure		Date: 10/01/2014
NEON Doc. #: NEON.DOC.000987	Author: C. Meier	Revision: D

Table 5. Equipment and materials required for a team of two to minimize exposure to toxic oils from *Toxicodendron spp.*

Item No.	R/S	Description	Example Item	Purpose	Quantity	Special Handling
Durable items						
	R	Labeled hand clippers, dedicated to <i>Toxicodendron</i> clipping		Minimize spread of oils to other equipment	1	N
	R	Labeled calipers for measuring <i>Toxicodendron</i> stem diameters		Minimize spread of oils to other equipment	1	N
	R	Labeled DBH tape		Minimize spread of oils to other equipment	1	N
Consumable items						
	R	Cotton gloves, single use	Gloves	Prevent oil contact with skin	Box of 12	N
	R	Disposable PPE outer-wear	Coveralls	Prevent oil contact with skin, normal clothing	Case of 24	N
	R	Large, single-use plastic bags	Trash bag or large Ziploc type bag	Transport used gloves and PPE and minimize toxic oil transfer	Box	N
	R	Cleanser, urushiol-specific	Tecnu or equivalent	Clean clippers or calipers after use	1	N

R/S=Required/Suggested

<i>Title:</i> TOS Protocol and Procedure: Measurement of Vegetation Structure		<i>Date:</i> 10/01/2014
<i>NEON Doc. #:</i> NEON.DOC.000987	<i>Author:</i> C. Meier	<i>Revision:</i> D

6.2 Training Requirements

All technicians must complete required safety training as defined in the NEON Training Plan (AD[04]). Additionally, technicians must complete protocol-specific training for safety and implementation of this protocol as required in Field Operations Job Instruction Training Plan (AD[05]).

Technicians must be trained in the proper care of the laser rangefinder and GeoXH 6000 GPS unit. Although these tools are resistant to dust and water, it is important to seal open ports and use lens caps when applicable. Care must also be taken to avoid scratching lenses and LCD screens.

Finally, technicians should be trained to carefully measure the heights of trees using the laser rangefinder/hypsometer. Specifically, in order to estimate tree heights accurately, it is important to understand the assumptions made by the instrument, as well as methods for dealing with situations that violate these assumptions.

6.3 Specialized Skills

At least one of the technicians executing this protocol must be able to identify regionally specific plants to species via visual inspection and use of a dichotomous/polyclave key.

6.4 Estimated Time

The time required to implement a protocol will vary depending on a number of factors, such as skill level, system diversity, environmental conditions, and distance between sample plots. The timeframe provided below is an estimate based on completion of a task by a skilled two-person team (i.e., not the time it takes at the beginning of the field season). Use this estimate as framework for assessing progress. If a task is taking significantly longer than the estimated time, a problem ticket should be submitted.

An experienced two-person team may complete mapping and tagging of woody stems within a single plot in 6-12 hours. Annual measurement of large stems and other woody vegetation components within a forested 40 m x 40 m Tower plot may require up to 16 hours to complete. Actual time requirements to complete vegetation structure measurements will vary greatly between sites and is dependent on the variety of growth forms present and the density within plots.

<i>Title:</i> TOS Protocol and Procedure: Measurement of Vegetation Structure		<i>Date:</i> 10/01/2014
<i>NEON Doc. #:</i> NEON.DOC.000987	<i>Author:</i> C. Meier	<i>Revision:</i> D

7 STANDARD OPERATING PROCEDURES

The tasks associated with collecting vegetation structure measurements is broken up here into five separate SOPs (A-E). The first, SOP A, will be completed in the Domain lab, in preparation for the field campaign. SOP A contains steps for loading plot data and data dictionaries onto the Trimble Geo XH 6000 GPS unit and calibrating the TruPulse 360B to collect accurate distance and azimuth readings. SOP B provides a decision tree for defining vegetation classifications based of morphology and a summary table of which vegetation structure measurements are required for each classification, this information will be essential for carrying out the tasks associated with SOP C and SOP D. SOP C, Mapping and Tagging, provides instructions for mapping individuals relative to plot markers and provides details for how to tag mapped trees, shrubs and lianas to enable tracking of individuals through time. The majority of field measurements are described in detail in SOP D, Biomass/Productivity Measurements; the procedure for making each of the measurements identified in SOP B is provided. Following field measurements, data must be transcribed from datasheets, downloaded from digital devices and field supplies must be replenished. The steps necessary to complete these tasks are provided in SOP E.

Title: TOS Protocol and Procedure: Measurement of Vegetation Structure		Date: 10/01/2014
NEON Doc. #: NEON.DOC.000987	Author: C. Meier	Revision: D

SOP A Preparing for Sampling

This SOP is to be completed in the domain lab, before going to the field.

A.1 Uploading plot data to the GPS

1. Transfer all required files containing plot marker locations to the GPS unit. Connect the GPS unit to the computer via a USB cable.

If using a high-resolution Trimble GeoXH 6000:

2. Launch Windows Mobile Device Center to ascertain that the device is communicating properly with the PC.
3. Open Pathfinder Office: without a license it will default to opening in Viewer Mode, which is sufficient for performing file-transfer tasks.
4. Within Pathfinder Office, open the Data-Transfer Utility to transfer the desired files (click “Utilities → Data Transfer”). DO NOT use Windows Explorer to copy/paste files.
5. The “Help” button within the Data Transfer Utility provides detailed instructions for carrying out file transfer.

A.2 Checking the TruPulse 360R laser rangefinder

1. Make sure the lenses on the TruPulse are free of dirt and debris, and clean with a lens cloth or lens tissue if necessary.
2. Declination changes with time at each site, and should be looked up annually at <http://www.ngdc.noaa.gov/geomag-web/>
3. *TruPulse Declination Offset.* Check the current declination against what is entered in the TruPulse. See Appendix D for details.
4. *TruPulse Tilt-sensor Calibration.* In the rare instance that the TruPulse has suffered a severe drop shock, the tilt-sensor requires re-calibration prior to continued field work. See Appendix D for details.

SOP B Defining Vegetation Classification

(Assess each separately; growth form is not tied to species for this protocol)

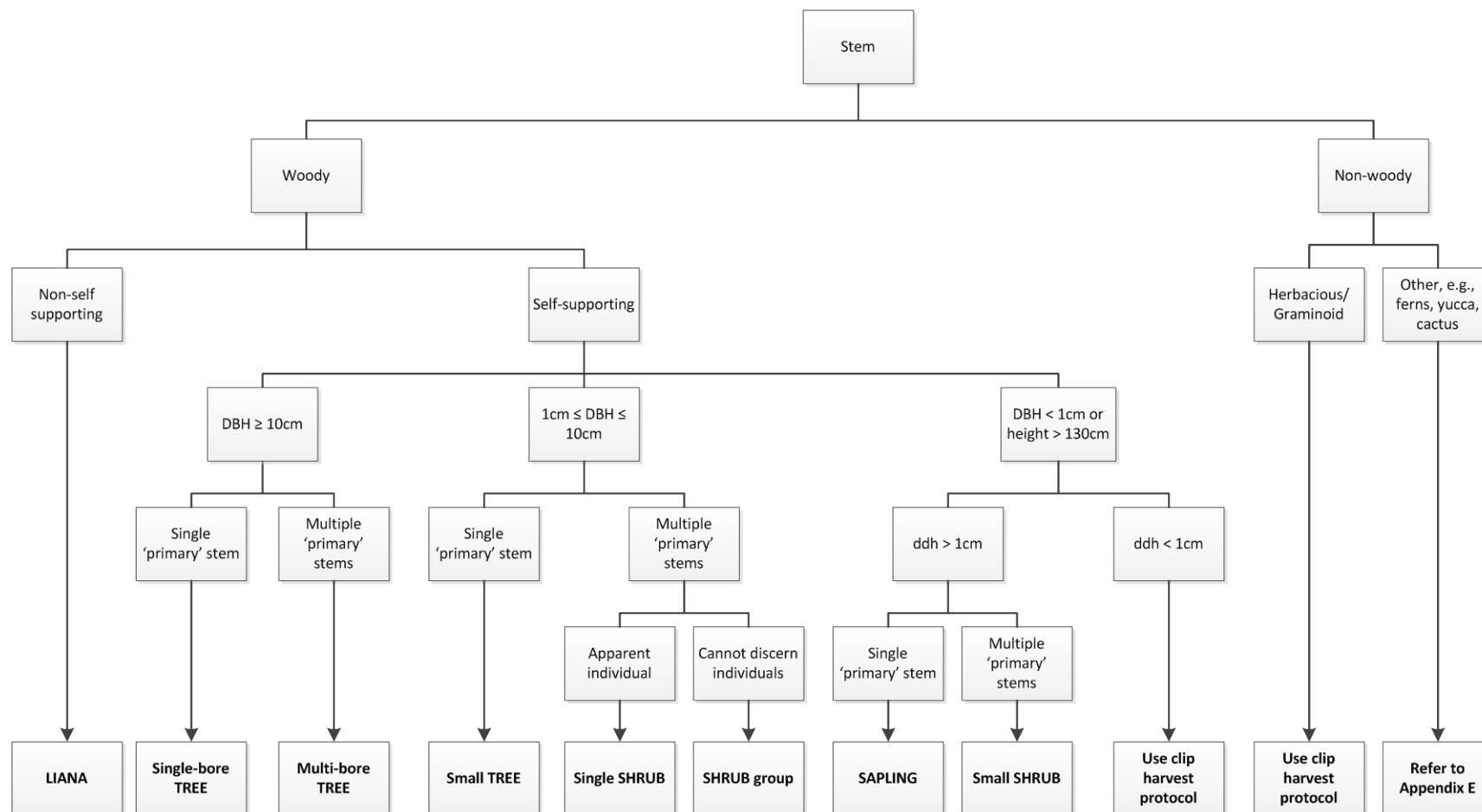

Figure 3. Decision tree for defining growth forms. Note: Species may change classification from one year to the next, for example due to a gain of qualifying stems, and individual may move from “small tree” to “single shrub”.

Title: TOS Protocol and Procedure: Measurement of Vegetation Structure		Date: 10/01/2014
NEON Doc. #: NEON.DOC.000987	Author: C. Meier	Revision: D

Table 6. Summary of biomass measurements required for each growth form. Note: Species may change classification from one year to the next, for example due to a gain of qualifying stems, and individual may move from “small tree” to “single shrub”.

Growth Form ¹	Map	Tag type and location	Stem Diameter	Height	Canopy Diameter	Additional Measurements
Liana (lia)	N/A	-Unique # -140 cm along stem	130 cm from rooting location or alternate heights according to Table 8	N/A	N/A	- nestedSubplotArea - scientificName - supporting stem stemID
Single bole tree (sbt)²	relative position	-Unique # -DBH + 10 cm	DBH	Maximum height, 2-shot TruPulse routine	Distributed Plots only: Maximum diameter and perpendicular to max	- scientificName - status - canopyPosition (distributed plots only)
Multi-bole tree (mbt)²	relative position of largest stem	- Unique # on largest stem -A,B,C... on all secondary stems > 10 cm DBH - DBH + 10 cm	DBH of all stems ≥ 10 cm @ 130 cm from ground	Maximum height, 2-shot TruPulse routine	Distributed Plots only: Maximum diameter and perpendicular to max	- scientificName - status - canopyPosition (distributed plots only)
Small shrub (sms)	N/A	-Unique ID, wire to conspicuous branch -ddh + 10 cm	ddh of all stems ≥ 1 cm @ 10 cm from ground	Maximum height, meter tape	Maximum diameter and perpendicular to max	- nestedSubplotArea - scientificName - shape

Title: TOS Protocol and Procedure: Measurement of Vegetation Structure		Date: 10/01/2014
NEON Doc. #: NEON.DOC.000987	Author: C. Meier	Revision: D

Growth Form ¹	Map	Tag type and location	Stem Diameter	Height	Canopy Diameter	Additional Measurements
Single shrub (sis)	relative position of center	-Unique # on main stem, no tag on secondary stems -DBH + 10 cm on primary stem Or -ddh + 10 cm on primary stem	- If ≤ 5 qualifying stems, DBH of all stems ≥ 1 cm @ 130 cm from ground - If > 5 stems ≥ 1 cm DBH, measure ddh, 10 cm above ground, all qualifying stems	TruPulse if height > 2 meters, meter tape for < 2 m	Maximum diameter and perpendicular to max	- nestedSubplotArea - scientificName - status - canopyPosition (distributed plots only) - shape
Shrub group (sgr)	N/A	No tag, unique ID assigned annually	N/A	5 tallest points within group	Canopy area; GPS if no overstory is present in plot otherwise, graph paper	- nestedSubplotArea - Species estimate of % contribution to total volume - % live per species - % dead per species
Small tree (smt)	relative position if no overstory is present in the plot	DBH + 10 cm	DBH	Maximum height, 2-shot TruPulse routine or meter tape	Distributed Plots with no overstory only: Maximum diameter and perpendicular to max	- nestedSubplotArea - scientificName - status
Sapling (sap)	N/A	ddh + 10 cm	ddh	Maximum height, 2-shot TruPulse routine or meter tape	N/A	- nestedSubplotArea - scientificName - status

¹ assess each individual separately; growth form is not tied to species for this protocol

² measure height of both single bole and multi-bole trees, regardless of status (i.e. measure snags/stumps as well)

Title: TOS Protocol and Procedure: Measurement of Vegetation Structure		Date: 10/01/2014
NEON Doc. #: NEON.DOC.000987	Author: C. Meier	Revision: D

SOP C Mapping and Tagging

C.1 Stem mapping

Small trees and shrubs can exist either as isolated individuals (with either single or multiple stems), or as groups of individuals in contact with each other such that a single individual cannot be distinguished from its neighbor (e.g. a continuous shrub thicket).

Apparent individuals are mapped as points and tagged with a unique aluminum ID tag for repeat measurements. The location of groups of individuals are mapped relative to the plot with polygons, but not tagged.

The procedure described here only applies to apparent individuals. Stems must be $\geq 50\%$ rooted in the plot in order to be considered 'in' and included in long term monitoring. Dead individuals are also tagged and mapped if they are mostly upright, not leaning more than 45° from vertical. Data collected as part of this SOP will be recorded in the SOP C: mapping and tagging datasheet.

C.2 Relative position

This procedure is for mapping trees and shrubs within a plot relative to established plot markers (see RD[08] for details). The following procedure will be completed for:

- Single bole trees >10 cm DBH
 - Multi-bole trees > 10 cm DBH
 - Single Shrubs
 - Small trees (only if no trees with DBH ≥ 10 cm are present in the entire plot)
1. Delineate the plot. Use existing plot markers, the 50 m tapes, and chaining pins to carefully delineate the plot and subplots. In this case, it is not necessary to pay attention to whether the plot is sloped or flat: the tape is used only to help determine which stems are "in" versus "out" of the plot.
 2. Mount the TruPulse on the non-magnetic tripod.
 3. Position the TruPulse directly over an existing plot marker for which high-resolution GPS coordinates have already been recorded.
 4. Record stem map data in the **SOP C: mapping and tagging** datasheet.
 5. Select a stem to map, attach a pre-numbered aluminum tag (see 'tagging' below), this number is the **stemID**.
 6. Record the **pointID**. This is the plot marker number over which the TruPulse is standing.
 - a. Refer to Figure 4 and Appendix G if plot markers are not numbered
 7. Record the **stemDistance** to the nearest 0.1 m using the TruPulse. This is the distance from the TruPulse to the base of the main stem, or the center of a shrub.
 - a. Press "Power/Fire" to turn on the TruPulse.

Title: TOS Protocol and Procedure: Measurement of Vegetation Structure		Date: 10/01/2014
NEON Doc. #: NEON.DOC.000987	Author: C. Meier	Revision: D

- b. Set the unit to Target Mode = Filter. Press either the ▲ or ▼ button until **HD** (i.e. Horizontal Distance) appears in the viewfinder.
 - c. Person 1: Hold the reflective surface at the base of the stem so that it is visible to Person 2.
 - d. Person 2: Look through the TruPulse viewfinder, aim the crosshairs at the reflective surface held by Person 1, and press and hold "Power/Fire" until the distance is displayed in the viewfinder; record this distance.
8. Record the **stemAzimuth** to the nearest 0.1 degree. This is the angle relative to True North from the chosen plot marker to the base of the main stem or center of shrub.
- a. After recording the **HD** to the stem above, press ▲ three times until **AZ** (i.e. azimuth from True North) appears in the viewfinder and the angle in degrees is displayed; record this angle.
 - b. The angle should be preceded by a "d" indicating that declination has been set for the TruPulse at your current location (as described in Appendix D.).
9. Record the **scientificName** and **idQ** code if needed (idQ = identificationQualifier). This should be either a binomial latin qualified according to technician confidence (Table 7)
- a. Record field keys used in the **nameAccordingToID** field at the top of the datasheet
 - b. When **stemStatus** = 2, dead (see SOP D), assign to species if possible. If it is not clear what species a dead stem is, assign to genus, family, hardwood/softwood, or unknown, in that order of preference.
 - c. If **scientificName** = unknown and the stem is alive, obtain leaf samples and bring back to the lab to identify.
 - 1) Place collected unknown specimens in sealable plastic bags.
 - 2) Label plant with a unique (to the technician) unknown name (according to guidelines in RD[07]), number, description, botanist, date, and plot number.

Table 7. identificationQualifier codes for species ID. Leave this field blank if technician is confident in the genus and species ID.

identificationQualifier	Description
cf. species	roughly equals but "not sure" about the species
aff. species	similar to, but is not the species
cf. genus	roughly equals but "not sure" about the genus
aff. genus	similar to, but is not the genus
cf. subspecies	roughly equals but "not sure" about the subspecies
aff. subspecies	similar to, but is not the subspecies
cf. family	roughly equals but "not sure" about the family
aff. family	similar to, but is not the family
cf. variety	roughly equals but "not sure" about the variety

Title: TOS Protocol and Procedure: Measurement of Vegetation Structure		Date: 10/01/2014
NEON Doc. #: NEON.DOC.000987	Author: C. Meier	Revision: D

10. Record the three letter **growthForm** code (Table 6). This is assessed for each individual rather than by species.



It is helpful to mark trees you have just measured with a small length of flagging in order to track work progress. All temporary flagging must be removed once data have been collected from all trees within a given subplot.

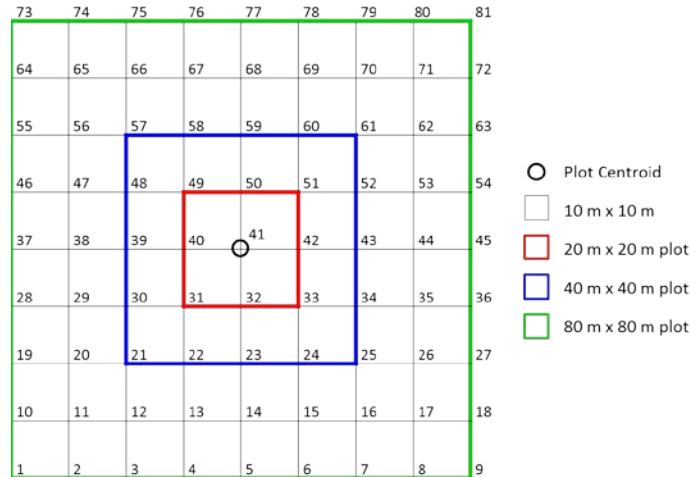

Figure 4. Point IDs for NEON plots of varying sizes

Title: TOS Protocol and Procedure: Measurement of Vegetation Structure		Date: 10/01/2014
NEON Doc. #: NEON.DOC.000987	Author: C. Meier	Revision: D

C.3 Tagging

As stems are mapped, attach an aluminum tag with **tagID** to the largest stem on the individual (according to specifications in Table 8) to enable repeat measurement. Tags are attached with either an aluminum nail or with aluminum wire wrapped loosely around the measured stem so that the wire will not cut into the stem as it grows. Wire should be used for any stems < 5 cm diameter at measurement height (DBH or ddh).

Table 8. Tag placement and method for each veg classification

Veg classification	Standard Tag height	Tag method
Liana	140 cm along stem from rooting	Attach with aluminum nail or loose wire, only one tag for each apparent individual despite branching
Single bole tree	140 cm (DBH+10 cm)	Attach with aluminum nail
Multi-bole tree	140 cm (DBH + 10 cm)	Attach with aluminum nail tagID on main stem label a blank aluminum tag with the steel die and hammer “a”, “b”, “c”, etc. for secondary stems > 10 cm DBH record secondary stem tagID as 1234a (on the datasheet)
Single shrub	140 cm (DBH + 10 cm)	Attach with aluminum nail or loose wire, if there are > 5 qualifying stems, do not tag each measured stem, mark with lumber crayon
Shrub group	No tag	N/A
Small shrub	20 cm (ddh + 10 cm)	Loose wire
Small tree	20 cm (ddh+ 10 cm)	Loose wire or aluminum nail
Sapling	20 cm (ddh+ 10 cm)	Loose wire

Title: TOS Protocol and Procedure: Measurement of Vegetation Structure		Date: 10/01/2014
NEON Doc. #: NEON.DOC.000987	Author: C. Meier	Revision: D

SOP D Biomass/Productivity Measurements

The measurements collected as part of this procedure will be used as variables in allometric equations to estimate biomass of individuals. Annual re-measurement of individuals will be used to calculate Annual Net Primary Production (ANPP). Generalized allometric equations vary by growth form and require different types of information. Here we describe field techniques for measuring DBH, ddh, height, canopy diameters, and canopy area. Refer to Table 6.

Woody stemmed vegetation may exhibit numerous growth forms – from single, straight boles to multiple curved, branched stems, to stems with adventitious roots that emerge some distance from the ground. Because of this variety, consistently choosing the appropriate measurement point is paramount. For the most part, this protocol adopts guidelines established by Gerwing et al. (2006), Schnitzer et al. (2008) and (Dahlin et al. 2011). Diameter measurements are taken at 130 cm (breast height, DBH) or at 10 cm from the ground (ddh).

Vegetation structure data are collected systematically from all woody stems rooted inside subplots of various sizes within each plot (Figure 2). Subplots may be either 10 m × 10 m (for 20 m × 20 m plots) or 20 m × 20 m (for 40 m × 40 m or larger plots). Subplots are numbered in according to the pointID of the SW corner of the subplot (Figure 2). Nested subplots are numbered in sequence beginning with the SW corner of the subplot; SW=1, SE=2, NW=3 NE=4.

All stems DBH ≥ 10 cm within a plot are mapped and measured regardless of density. However, nested subplots may be employed to constrain measurement effort for lianas, shrubs and small diameter trees. Only measure stems where ≥ 50% of the individual (or ≥ 50% of the stems, for a multi-stemmed individual) are rooted within the measurement area. **Each plot that is visited must be assessed for the presence of these growth forms, and measured accordingly.** Assessments should take place every time a plot is measured.

- Record stem measurement data in the SOP D: Biomass/Productivity Measurements, Apparent Individuals datasheet.
- If collecting data electronically using the TerraSync software, make sure the file from the previous subplot has been closed, and create a new file for each Subplot. If a file is already open because data were just collected from the current subplot, you may continue to collect data in the same file.

During annual re-measurement of a plot, pay careful attention to:

- map, measure, and tag new stems that now meet the minimum 10 cm DBH cutoff; and
 - update stem status as some individuals may have died, others may have become damaged.
- Digital data collection: File naming

Title: TOS Protocol and Procedure: Measurement of Vegetation Structure		Date: 10/01/2014
NEON Doc. #: NEON.DOC.000987	Author: C. Meier	Revision: D

When collecting data with the Trimble GeoXH running TerraSync, create a new, appropriately named TerraSync data file for each plot module – this minimizes the risk of lost data should the PDA crash or should batteries fail during data collection. Name files according to the following convention:

1. Filename begins with the **plotID**: E.g. “HARV_001” for a plot at the D01 Harvard Forest core site.
2. The plotID code is followed by an underscore and two digits denoting the **subplot number** within the plot.
 - a. Example of an acceptable filename: HARV_001_02
3. Once the file is properly named, it is important to select the “Woody Veg Structure” Data Dictionary.

D.1 Selecting a measurement area, nested subplots

Small diameter trees (including saplings), shrubs and lianas are measured on a per subplot basis within plots in order to facilitate tracking individuals that have and have not been measured. Because saplings, shrubs and lianas can attain very high stem densities, even within a single subplot, it may be necessary to employ a nested subplot approach in order to keep the number of mapped and measured individuals manageable (Figure 2). To be consistent within plots, the same size measurement unit (e.g. the chosen nested subplot size) should be used for the entire plot, and the same size subplots within a given plot should be used from year to year.

1. If a plot HAS been measured previously use the **same measurement area each year (nestedSubplotArea)** in order to ensure that repeat measurements are made on tagged stems. Check the QAQC datasheet which summarizes measurement area for all plots before selecting a new measurement area for a given plot.
2. Select measurement area separately for 1) lianas, 2) small trees, sapling, single shrubs, shrub groups, small shrubs 3) other qualifying non-herbaceous vegetation (Appendix E).
3. Visually assess the stem density of qualifying stems across the whole plot
4. Select a measurement area that will capture approximately 40 stems per 400 m²
 - ~ 40 stems / 20 m x 20 m plot/subplot
 - ~ 10 stems / subplot (20 m x 20 m plot)
 - ~ 5 stems / nested subplot (20 m x 20 m plot)
 - ~ 20 stems / nested subplot (40 m x 40 m plot)

Note: If the step from one nested subplot size represents a large jump in the number of individuals such that too few stems would be sampled at one size and the next larger would capture >40 stems per 400m² select the larger size plot.

5. Record the selected **nestedSubplotArea** (1, 10,30 m²) for each vegetation category in the ‘QAQC datasheet’ RD[12].

Title: TOS Protocol and Procedure: Measurement of Vegetation Structure		Date: 10/01/2014
NEON Doc. #: NEON.DOC.000987	Author: C. Meier	Revision: D

D.2 Setting up a plot

1. Delineate the plot. Use existing plot markers, the 50 m tapes, and chaining pins to carefully delineate the plot and subplots. In this case, it is not necessary to pay attention to whether the plot is sloped or flat: the tape is used only to help determine which stems are “in” versus “out” of the plot.
 - Refer to the Plot Establishment Protocol (RD[08]) for a review of tape wrapping techniques that can be used to delineate modules or subplots.
2. **Check the QA/QC datasheet to determine whether a plot has been measured before, and if so, which nested subplot area must be used.** If a plot has been measured before, it is important to use the same subplot size each year, so that tagged, mapped individuals can be tracked through time.
3. Delineate nested subplots . The one-sided length of the nested subplots shown in Figure 2 are as follows:
 - 1 m² red subplot = 1 m
 - 10 m² blue subplot = 3.16 m
 - 30 m² dashed grey subplot = 5.48 m

D.3 Stem diameter

Stem diameter will be measured for all qualifying stems within the measurement area. This applies to all growth forms defined in SOP B:

- Lianas
- Single bole trees
- Multi-bole trees
- Single Shrubs
- Stems within a shrub group
- Small trees
- Small shrubs
- Saplings

If abnormalities exist at the desired measurement height, measure according to rules in Table 9.

Title: TOS Protocol and Procedure: Measurement of Vegetation Structure		Date: 10/01/2014
NEON Doc. #: NEON.DOC.000987	Author: C. Meier	Revision: D

Diameter at Breast Height (DBH)

Guidelines for determining the measurement location for DBH are provided in Table 9.

- Use a DBH tape for stems with DBH \geq 5 cm.
 - Use calipers for stems with DBH $<$ 5 cm and all lianas
1. If this is the first time a stem has been measured, mark the measurement location with lumber crayon so that repeat measurements at exactly the same location are possible
 2. Mark stems with DBH \geq 30 cm at multiple points around the bole to ensure accurate re-measurement.
 3. Place the DBH tape or calipers directly over the lumber crayon marking(s). For large boles, the tape must not slip above or below the desired measurement point.
 4. For each stem with DBH \geq 10 cm, do the following:
 - a. Record the **plotID** and the **subplotID**(the “nestedSubplotID” and “nestedSubplotArea” fields on the datasheet are left blank for stems with DBH \geq 10 cm).
 - b. Record the **stemID** from the aluminum tag.
 5. Record the **stemDiameter** (or stems, for qualifying multi-stemmed individuals) to the nearest 0.1 cm.
 6. Record the **measurementHeight**, DBH (130 cm from ground), ddh (10 cm from ground), or other height if an adjustment in necessary because of stem abnormality
 - For trees and shrubs with anomalous and complicated growth forms that are not adequately described here, measurement location and method may be determined according to the guidelines for measuring lianas (below).
 7. If measuring diameter on a stem which is $>$ 5 cm DBH and is a supporting stem for lianas, attempt to thread tape under liana stems if possible; if not possible, measure whole diameter (supporting stem + liana) and note about how measurement was taken in the ‘Notes’ datasheet and indicate that there is a note by check marking remarks field on the ‘apparent individuals’ datasheet.



It is helpful to mark trees you have just measured with a small length of flagging in order to track work progress. All temporary flagging must be removed once data have been collected from all trees within a given module.

Title: TOS Protocol and Procedure: Measurement of Vegetation Structure		Date: 10/01/2014
NEON Doc. #: NEON.DOC.000987	Author: C. Meier	Revision: D

Table 9. Rules for determining the appropriate DBH measurement location

Location of DBH Measurements for Trees (and for Lianas* with DBH ≥ 1 cm)	
Stem/Site Characteristics	Appropriate Point on Stem for DBH Measurement
Straight, single-bole, growing on level ground	Measure DBH 130 cm straight up from ground.
Growing on slope or uneven terrain	Measure DBH 130 cm from uphill side.
Leaning stem	Measure 130 cm at angle along stem (not perpendicular to ground). Diameter measurement is at an angle (i.e., not parallel to ground).
Stems with anomalies at 130 cm (e.g., big bulge, node/branch, or damage).	Measure DBH 5 cm below the anomaly where stem becomes “normal” again. Record the measurement height in measurementHeight field on data sheet.
Stems that branch or split into multiple boles below 130 cm.	Measure DBH 20 cm below the branch/split point where the stem is regular. Record the measurement height in measurementHeight field on data sheet.

* Additional guidelines for measurement location on lianas, below. Safe handling of *Toxicodendron* species provided in Appendix F

Guidelines for measuring DBH of Lianas



Figure 5. Situations that determine the location at which liana DBH should be measured

Title: TOS Protocol and Procedure: Measurement of Vegetation Structure		Date: 10/01/2014
NEON Doc. #: NEON.DOC.000987	Author: C. Meier	Revision: D

Lines A through G below describe common situations presented by the same letter in Figure 5 (excerpted from Gerwing et al. 2006). (H through R): Situations that may affect location of the DBH measurement point for lianas; see Schnitzer et al. (2008) for a full description of these less common scenarios.

- A. Lianas that simply ascend into the canopy are measured 130 cm along the stem from the main rooting point.
- B. Twining lianas are measured 130 cm along the stem from the rooting point, including all twists and curves.
- C. Lianas that branch below 130 cm from the rooting point are measured 20 cm below the branching point.
 - (1) If the branch point is less than 40 cm from the ground, measure half-way between the branch point and the ground, where the stem is regular.
 - (2) If the stem is not regular anywhere between the branch point and the ground, measure according to “G” below.
- D. Lianas that loop to the ground and root again before ascending to the canopy are measured 130 cm from the last rooting point.
- E. Like D, but the loops have branches that ascend to the canopy. Each rooted ascending stem with a leafy canopy branch is recorded separately as a clonal stem with the same **tagID**.
- F. Lianas with rooted adventitious roots further than 80 cm from the main rooting point are measured 50 cm past the last root.
- G. Lianas that branch below 130 cm, but have a very irregular main stem or branch close to the ground. Measure branches separately at 130 cm, and record data with the same **tagID**.

Diameter at Decimeter Height (DDH)

Diameter at decimeter height (DDH) will be measured for all stems > 1 cm diameter and < 130 cm height and all shrubs with > 5 stems with DBH > 1 cm. The strategy for measuring DDH is similar to that described for DBH above except that measurements will be taken on primary stems > 1cm diameter at 10 cm from the ground. All stems that do not meet this criterion will not be measured.

- Remember: Use calipers for all diameter measurements < 5 cm.
- Stems are never perfectly round; therefore, measure the longest and shortest diameter axes of stems and record the average stem diameter.

Title: TOS Protocol and Procedure: Measurement of Vegetation Structure		Date: 10/01/2014
NEON Doc. #: NEON.DOC.000987	Author: C. Meier	Revision: D

D.4 Stem height

Record the stem height at the highest canopy point to the nearest 0.1 meter, using the TruPulse. Stem height is always height above the ground, not length of the stem – i.e. for leaning stems, measure the highest point above the ground.

- **VD1:** The vertical distance from the highest canopy point to the observer, typically a positive number.
- **VD2:** The vertical distance from the base of the stem where it meets the ground to the observer, typically a negative number.

Individuals with height > approximately 2 m:

- Use the TruPulse 360R (see Appendix D).
- Record both **heightVD1** and **heightVD2**
- On uneven or sloped terrain, measure VD2 from the uphill side of the stem base.

For individuals with height < approximately 2 m:

- Use a meter tape.
- Manually stretch the tape from the ground to the top of the canopy.
- If the individual is growing on uneven or sloped terrain, measure from the uphill side of the stem(s).
- Record the value from the meter tape as **heightVD1**, and enter a “0” (zero) for **heightVD2**.

For shrub groups:

- Use either the TruPulse (> 2 m) or a meter tape (< 2 m)
- Record the **height** of each of the tallest 5 stems within the group, to the nearest 0.1 m
- Use the ‘**Shrub Groups**’ datasheet

Title: TOS Protocol and Procedure: Measurement of Vegetation Structure		Date: 10/01/2014
NEON Doc. #: NEON.DOC.000987	Author: C. Meier	Revision: D

D.5 Canopy diameter

Record the **canopy diameter** for each individual to the nearest 0.1 m, two measurements will be recorded:

- **diameterMax** = the maximum extent of the canopy
- **diameter90** = the diameter at 90° to diameterMax

Canopy diameters can be measured via either of the two techniques outlined in Appendix D, section D.8 and are required for the following growth forms:

- All single shrubs and small shrubs in the selected measurement area
- Trees ≥ 10 cm DBH at *Distributed plots only*
- Small trees within the selected measurement area in *Distributed plots* that do *not* have an overstory (i.e. crown class = 1)

D.6 Stem status

Record the **stemStatus** according to the definitions provided in Table 10.

Table 10. Stem Status value definitions

1	Live tree – any live tree (new, re-measured or ingrowth)
2	Dead tree – any dead tree (new, re-measured), regardless of cause of death.
3	Removed – a tree that has been cut and removed by direct human activity related to harvesting, silviculture or land clearing (re-measurement plots only).
4	Damaged - insect
5	Damaged - disease
6	Damaged – abiotic (i.e. lightning strike, windthrow, fire etc)
7	Damaged - other

Title: TOS Protocol and Procedure: Measurement of Vegetation Structure		Date: 10/01/2014
NEON Doc. #: NEON.DOC.000987	Author: C. Meier	Revision: D

D.7 Canopy Position

Record the **canopyPosition** according to the definitions provided in Table 11.





Table 11. Canopy position definitions. Modified from USFS Forest Inventory Analysis program Crown Class definitions (USDA, Forest Service 2011)

1	Open Grown – Full sun, not touching other plants - crowns that received full light from above and from all sides throughout most of its life, particularly during its early developmental period.
2	Dominant – Full sun -crowns extending above the general level of the canopy and receiving full light from above and partly from the sides. These individuals are taller than the average in the stand and their crowns are well developed, but they could be somewhat crowded on the sides. Also, individuals whose crowns have received full light from above and from all sides during early development and most of their life. Their crown form or shape appears to be free of influence from neighboring plants.
3	Co-dominant – Partially shaded -individuals with crowns at the general level of the crown canopy. Crowns receive full light from above but little direct sunlight penetrates their sides. Usually they have medium-sized crowns and are somewhat crowded from the sides. In stagnated stands, co-dominant trees have small-sized crowns and are crowded on the sides.
4	Intermediate – Mostly shaded - individuals that are shorter than dominants and co-dominants, but their crowns extend into the canopy of co-dominant and dominant trees. They receive little direct light from above and none from the sides. As a result, intermediate trees usually have small crowns and are very crowded from the sides.
5	Overtopped – Full shade - individuals with crowns entirely below the general level of the crown canopy that receive no direct sunlight either from above or the sides.

D.8 Shrub shape

Shrub canopy dimensions and height will be used to calculate volume but in order to produce the most accurate estimates, shrub volume must be calculated according to a three dimensional shape. Record the **shape** of each measured shrub according to the guidelines in Table 12.

Table 12. Shrub shapes for volume estimates.

Shape	Example	Additional measurements
Half- sphere (hsp)		None
Oblate half sphere (ohs)		None
Cone (cne)		None
Inverted cone* (icn)		baseCrown diameterMax, ¹ baseCrown diameter90
Cylinder (cyl)		None

* images from (Ludwig, Reynolds, and Whitson 1975)

¹ Measure at ground level

Title: TOS Protocol and Procedure: Measurement of Vegetation Structure		Date: 10/01/2014
NEON Doc. #: NEON.DOC.000987	Author: C. Meier	Revision: D

D.9 Canopy area

Shrub groups are not mapped, not tagged, and are measured by volume calculated as Canopy area x height. If a group is dense and covers an entire measurement area, there is no need to map or tag individual stems: simply record that cover is 100% of the measurement area.

Shrub groups are mapped using graph paper, with the area covered by the group determined by counting the number of graph squares within the group. These steps are illustrated in Figure 6.

For grouped individuals, data are recorded on the SOP D: **Biomass/Productivity Shrub Groups** datasheet. To measure grouped stems:

1. Assess the % cover of the group relative to the measurement area:
 - a. If cover is 100% - i.e. stems are very dense, and a more-or-less continuous group covers the entire measurement area. There is no need to map the group of stems.
 - Record the nestedSubplotArea for the canopyArea, e.g., if the nestedSubplotArea = 30m² and cover is 100%, canopyArea=30.
 - b. If the group does not cover the entire measurement area, then map the area of the group according to either the GPS or graph paper methods described below.
2. Label plotID, subplotID, nestedSubplotID, nestedSubplotArea
3. Draw the measurement area boundaries, (1 cm² = 1 m²)
4. Draw, to scale, the shape of the shrub group within the measurement area
5. Count the number of grid cells contained within the sketched group, begin with whole cells then add up partial cells.
6. Record this number on the grid paper and in the field datasheet **canopyArea**

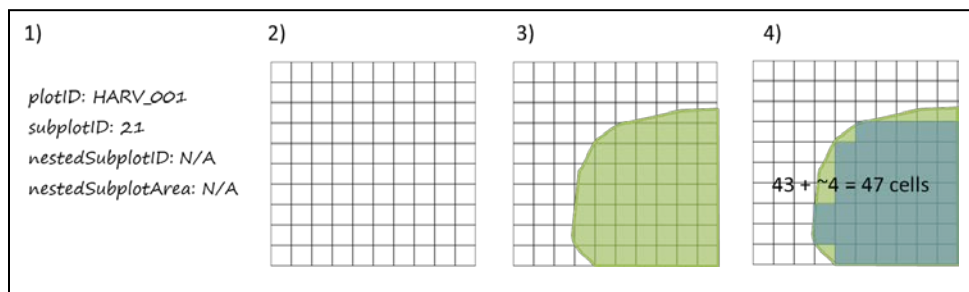

Figure 6. Example of graph paper method for determining shrub group area within a 10 m x 10 m subplot. The numbers 1-4 correspond to steps described for this operation. In this example, canopyArea = 47.

<i>Title:</i> TOS Protocol and Procedure: Measurement of Vegetation Structure		<i>Date:</i> 10/01/2014
<i>NEON Doc. #:</i> NEON.DOC.000987	<i>Author:</i> C. Meier	<i>Revision:</i> D

Additional shrub group measurements

1. Record the % contribution by volume (ocular estimation) of each species within in the shrub group.
 - If more than 1 species is present, record each species, volume and stem count on a separate row of the datasheet. Do not repeat group level data (i.e location, canopy area, canopy position, height)
 - Sum of the volume of all species present should = 100
2. Record the % live and % dead for each species present
 - Sum of % live and % dead should = 100 for each species.

Title: TOS Protocol and Procedure: Measurement of Vegetation Structure		Date: 10/01/2014
NEON Doc. #: NEON.DOC.000987	Author: C. Meier	Revision: D

SOP E Field Campaign Follow-up

E.1 Sample preservation

Place plastic bags with unknown voucher specimens in a refrigerator until they are identified and/or placed in a plant press and dried for identification at a later date. **Specimens should not be left in the refrigerator for more than two days.** Identification often requires a variety of dichotomous keys, a dissecting microscope, a dissecting kit, and a herbarium with voucher specimens for verification.

E.2 Refreshing the sampling kit

1. Recharge batteries on the high-resolution GPS unit.
2. Make sure there are either 1) adequate supplies of fresh replacement batteries for the TruPulse 360R (type CR123A); or 2) rechargeable batteries are re-charged.
3. Check that supplies of lens tissue are adequate.
4. Check that supplies of consumable materials are adequate.

E.3 Equipment maintenance, cleaning, and storage

1. If necessary, clean the lenses on the TruPulse with a lens cloth or lens tissue.
2. Remove Data Dictionary and plot location files that are no longer needed from the high-resolution GPS unit.

<i>Title:</i> TOS Protocol and Procedure: Measurement of Vegetation Structure		<i>Date:</i> 10/01/2014
<i>NEON Doc. #:</i> NEON.DOC.000987	<i>Author:</i> C. Meier	<i>Revision:</i> D

SOP F Data Entry and Verification

As a best practice, field data collected on paper datasheets should be digitally transcribed within 7 days of collection or the end of a sampling bout (where applicable). However, given logistical constraints, the maximum timeline for entering data is within 14 days of collection or the end of a sampling bout (where applicable). See RD[04] for complete instructions regarding manual data transcription.

Upon returning to the lab, data collected in the field should be transferred to NEON servers.

Stem Data Collected Manually with Paper Datasheets

If data were collected manually, transcribe into the appropriate Excel ingest spreadsheet according to the procedure outlined in the data entry protocol (RD[04]).

1. There should be one Excel file containing vegetation structure ingest worksheets corresponding to each of the four field datasheets for all of the plots measured in a given year.
 - a. Enter data into the data entry tabs, identified by 'E_' preceding the tab name. Choose the appropriate tab for the field datasheets at hand.
 - b. Once data have been entered from all plots, save each tab as a .csv file for CI ingest.
2. Following the first mapping bout at a site, the QAQC datasheet may be filled out as plot data are entered in the ingest workbook to minimize the number of active datasheets in the field.

<i>Title:</i> TOS Protocol and Procedure: Measurement of Vegetation Structure		<i>Date:</i> 10/01/2014
<i>NEON Doc. #:</i> NEON.DOC.000987	<i>Author:</i> C. Meier	<i>Revision:</i> D

SOP G Sample Shipment

This protocol produces no samples for laboratory analysis, so no shipping details are provided.

Title: TOS Protocol and Procedure: Measurement of Vegetation Structure		Date: 10/01/2014
NEON Doc. #: NEON.DOC.000987	Author: C. Meier	Revision: D

8 REFERENCES

- Dahlin, K. M., G. P. Asner, and C. B. Field. 2011. Environmental filtering and land-use history drive patterns in biomass accumulation in a mediterranean-type landscape. *Ecological Applications* **22**:104-118.
- Gerwing, J. J., S. A. Schnitzer, R. J. Burnham, F. Bongers, J. Chave, S. J. DeWalt, C. E. N. Ewango, R. Foster, D. Kenfack, M. Martínez-Ramos, M. Parren, N. Parthasarathy, D. R. Pérez-Salicrup, F. E. Putz, and D. W. Thomas. 2006. A standard protocol for liana censuses. *Biotropica* **38**:256-261.
- Schnitzer, S. A., S. Rutishauser, and S. Aguilar. 2008. Supplemental protocol for liana censuses. *Forest Ecology and Management* **255**:1044-1049.
- Ludwig, John A., James F. Reynolds, and Paul D. Whitson. 1975. "Size-Biomass Relationships of Several Chihuahuan Desert Shrubs." *American Midland Naturalist*: 451–461.
- USDA, Forest Service. 2011. "Forest Inventory and Analysis National Core Field Guide. Volume I : Field Data Collection Procedures for Phase 2 Plots. Version 5.1."

<i>Title:</i> TOS Protocol and Procedure: Measurement of Vegetation Structure		<i>Date:</i> 10/01/2014
<i>NEON Doc. #:</i> NEON.DOC.000987	<i>Author:</i> C. Meier	<i>Revision:</i> D

APPENDIX A DATASHEETS

The following datasheets are associated with this protocol:

Table 13. Datasheets associated with this protocol

NEON Doc. #	Title
NEON.DOC.001573	Datasheets for TOS Protocol and Procedure: Measurement of Vegetation Structure

These datasheets can be found in Agile or the NEON Document Warehouse.

Title: TOS Protocol and Procedure: Measurement of Vegetation Structure		Date: 10/01/2014
NEON Doc. #: NEON.DOC.000987	Author: C. Meier	Revision: D

APPENDIX B QUICK REFERENCES

B.1 Quick Reference: Making Quality Measurements of Woody Vegetation Structure

Step 1 – Calibrate TruPulse.

Step 2 – Delineate measurement area.

Step 3 – Assess need for subplots (for new plots only).

Step 4 – Tag and identify species of each qualifying individual (new plots and as needed in existing plots). See summary tables on next page for location and method of tagging.

Step 5 – Record metadata on data sheets (Plot ID, Module #, Subplot # and Size).

Step 6 – Take and record measurements:

Trees	Small Trees	Shrubs	Shrub Groups	Lianas
Stem diameter	Stem diameter	Stem diameter/s	% of group volume by species	Stem diameter
Canopy position		Canopy position		
Height	Height	Height	Height five tallest stems	
Canopy diameter (Distributed plots)		Canopy diameter	Canopy area	
Stem status	Stem status	Stem Status	% live/dead by species	Stem status

Step 7 – Remove temporary flagging.

For directions on using the TruPulse, see Using the TruPulse 360R Laser Rangefinder Field Sampling Manual.

Title: TOS Protocol and Procedure: Measurement of Vegetation Structure		Date: 10/01/2014
NEON Doc. #: NEON.DOC.000987	Author: C. Meier	Revision: D

B.2 Quick Reference: Summary Tables for Marking and Tagging Plants

Methods for Attaching ID Tag and Marking Trees for DBH Measurements	
DBH/Stem Characteristic (growth form)	Tagging/Marking Method (Place tag at 140 cm, mark at 130 cm unless otherwise indicated.)
DBH \geq 30 cm (Trees)	Aluminum nail for ID tag on main stem. Additional mark on opposite side of trunk at desired height.
10 cm \leq DBH < 30 cm (Trees)	Aluminum nail and ID tag on main stem.
Multi-stemmed individuals (Multi-bole Trees) (i.e., those that fork into 2 or more boles below 130 cm)	Same as above for first measurement location. Add'l stems with DBH \geq 10 cm: custom tag**.
1 cm \leq DBH < 10 cm and less than 5 stems (with qualifying DBH) (Liana, Single shrub and Small tree)	Attach tag to largest stem. Mark same point with lumber crayon. Mark other qualifying stems with lumber crayon and attach custom tag**.
1 cm \leq DBH < 10 cm and more than 5 stems (with qualifying DBH) or height < 130 cm (Single shrub and small shrub)	Attach tag to largest stem at decimeter height (10 cm above ground) Mark location with lumber crayon. Mark (but do not tag) other qualifying stems with lumber crayon at ddh.

*Attach tags at measurement point with either aluminum nails or wire. Wire recommended if DBH < 5 cm. Wrap wire loosely to avoid cutting stem as it grows.

** Custom tag: Use steel die and hammer to label blank aluminum tag with tag IDs "a", "b", "c", etc.

Title: TOS Protocol and Procedure: Measurement of Vegetation Structure		Date: 10/01/2014
NEON Doc. #: NEON.DOC.000987	Author: C. Meier	Revision: D

APPENDIX C REMINDERS

Making quality measurements of vegetation structure

Measurement Area: Make sure to know...

- Size of plot and subplots.
- Number of subplots in the plot.
- Size of nested subplots (if any) for plots previously measured.
- How to determine whether nested subplots are needed for new plots.

Taking Measurements: Remember to...

- Include stem in module or subplot if > 50% of the individual (or > 50% of stems for multi-stemmed plants) are rooted in the measurement area.
- Use temporary flagging to distinguish measured and unmeasured stems.
- Carefully record all metadata, measurements, and observations on data sheet.
- Mark, map, and tag new individuals that meet minimum size cutoff.
- Identify previously tagged stems that have died since last measurement.
- Remove temporary flagging when measurements are completed

Using the TruPulse: Pay close attention to...

- Declination – Is it set for your current location?
- Selection choices in drop-down menu.
- Battery charge – Replace when low-charge indicated.
- Transcription of measurements onto data sheet.
- Metal objects – Keep them at least 2 feet away from instrument when using internal compass.

Directions for the TruPulse are in the *Using the TruPulse 360R Laser Rangefinder Field Manual*.

Title: TOS Protocol and Procedure: Measurement of Vegetation Structure		Date: 10/01/2014
NEON Doc. #: NEON.DOC.000987	Author: C. Meier	Revision: D

APPENDIX D USING AND CALIBRATING THE TRUPULSE 360R

D.1 Setting the declination of the internal compass

Declination changes with time and space so must be looked up annually for a given location. Positive declination values are East, negative values are West. Obtain the current declination values for your location from <http://www.ngdc.noaa.gov/geomag-web/#declination> and be sure to note the positive or negative sign before heading into the field.

The following procedure can be used to check and set the declination (if necessary) on the TruPulse 360R Laser Rangefinder:

1. Press the “Power/Fire” button to turn on the unit. The viewfinder will display the main “Measurement Mode” screen.
2. Press and hold ▼ for 4 s to enter “System Setup Mode”. Units will appear in the Main Display.
3. Press ▼ until H_Ang is displayed in the viewfinder, then press “Power/Fire”.
4. dECLn will be displayed in the viewfinder, press “Power/Fire”.
5. no and dECLn will blink. Press ▼ until YES and dECLn blink, then press “Power/Fire” again. The current declination is shown in the viewfinder (Figure 7).
6. If this is the correct value, press and hold ▲ to return to the main “Measurement Mode” screen.

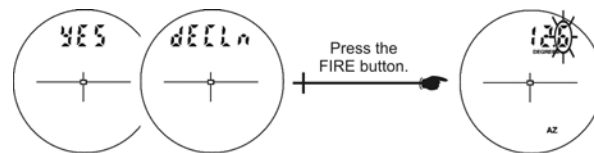

Figure 7. TruPulse 360R Laser Rangefinder viewfinder showing a user-entered declination value

7. If the displayed value is incorrect for your current location:
 - a. Press either ▲ or ▼ to change the tenths value, press “Power/fire”.
 - b. Press either ▲ or ▼ to change first integer value, press “Power/fire”.
 - c. Press either ▲ or ▼ to change second integer value, press “Power/fire”.
 - d. The value just entered will blink. Press “Power/fire” to confirm and return to the “Measurement Mode” screen.

Title: TOS Protocol and Procedure: Measurement of Vegetation Structure		Date: 10/01/2014
NEON Doc. #: NEON.DOC.000987	Author: C. Meier	Revision: D

D.2 Calibrating the tilt sensor

In the rare case that the TruPulse 360R Laser Rangefinder suffers severe drop shock, the following procedure can be used to calibrate the tilt sensor (vertical angle) on the TruPulse 360R Laser Rangefinder:

1. Press the “Power/Fire” button to turn on the unit. The viewfinder will display the main “Measurement Mode” screen.
2. Press and hold ▼ for 4 s to enter “System Setup Mode”. UnitS will appear in the Main Display.
3. Press ▼ until inC is displayed in the viewfinder, then press “Power/Fire” (Figure 8).
4. no and CAL will blink. Press ▼ until yes and CAL blink, then press “Power/Fire” again.
 - o Calibration can be aborted by pressing “Power/Fire” when no and CAL are alternately displayed.

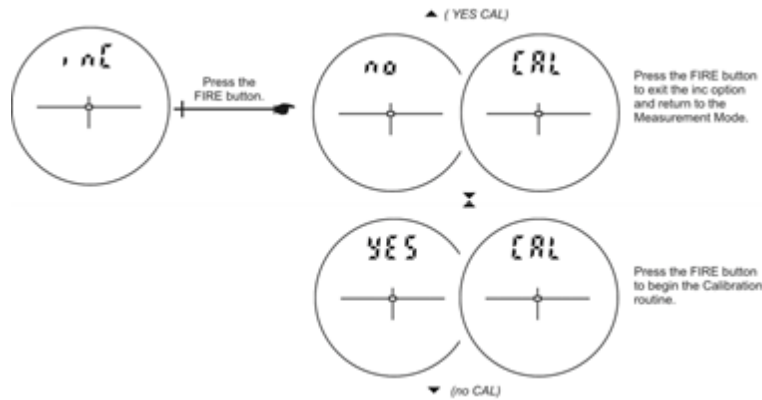

Figure 8. TruPulse 360R Laser Rangefinder viewfinder when initiating the tilt-sensor calibration routine

5. C1_Fd will be displayed in the view finder.
6. Place the TruPulse 360R Laser Rangefinder on a relatively flat surface (within 15deg of level), and follow the sequence outlined in Figure 9 below.
 - a. At each step wait approximately 1 second before pressing “Power/fire”, then wait another second before moving to the next position. It is important that the unit is held steady when you press “Power/fire”.
 - b. To abort and return to previous calibration at any point hold ▲ or ▼ for 4 sec.

Title: TOS Protocol and Procedure: Measurement of Vegetation Structure		Date: 10/01/2014
NEON Doc. #: NEON.DOC.000987	Author: C. Meier	Revision: D

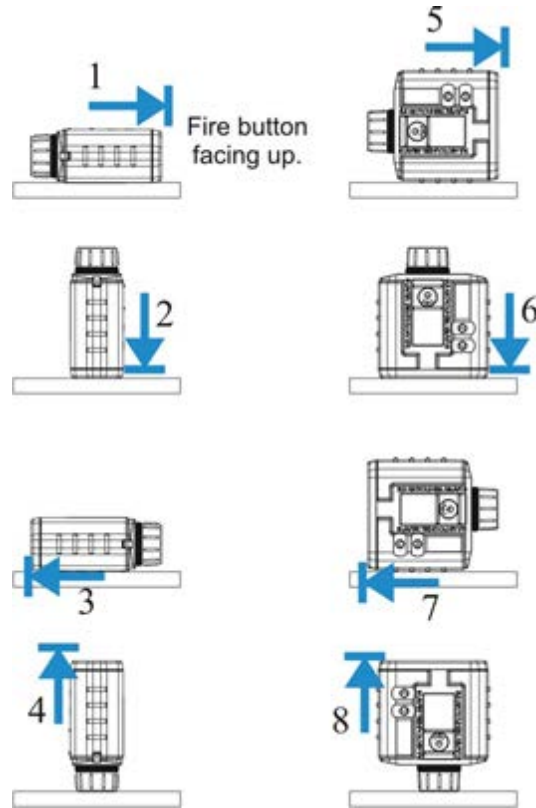

Figure 9. TruPulse 360R Laser Rangefinder tilt-sensor calibration routine

7. After all 8 positions have been run through, look through the eyepiece. Either a PASS or FAiL message appears in the view finder.
 - a. PASS: Press the “Power/Fire” Button to return to the measurement mode.
 - b. FAiL1: Excessive motion during calibration. Unit was not held steady.
 - c. FAiL2: Magnetic saturation error. Local magnetic field too strong.
 - d. FAiL3: Mathematical fit error.
 - e. FAiL4: Calibration convergence error.
 - f. FAiL6: Orientations were wrong during the calibrations.
8. If FAiL appears, press the “Power/Fire” button. No and CAL will alternately blink allowing you to do a new calibration. IF the calibration fails, the unit reverts to the previous calibration.

D.3 Calibrating the internal compass



The internal compass of the TruPulse 360R Laser Rangefinder is susceptible to error. When beginning a new plot, the TruPulse 360R Laser Rangefinder should be checked against an actual compass or a previously established plot line. **ALWAYS CHECK AND RECALIBRATE THE COMPASS AFTER CHANGING THE BATTERIES!** It is not uncommon for the compass calibration to be inaccurate when the low battery indicator is displayed in the view finder, and you should replace the batteries when this indicator appears.

To calibrate the internal compass of the TruPulse 360R Laser Rangefinder, use the following procedure:

1. Before calibrating the internal compass, take the TruPulse 360R Laser Rangefinder outside (away from local electromagnetic interference) and at least 2 feet away from all (magnetic) metal objects (including watches, etc.).
2. Press the “Power/Fire” button to turn on the unit. The viewfinder will display the main “Measurement Mode” screen.
3. Press and hold ▼ for 4 s to enter “System Setup Mode”. UnitS will appear in the Main Display.
4. Press ▼ until H_Ang is displayed in the viewfinder, then press “Power/Fire”.
5. dECLn is displayed. Press ▼ to display the HACAL option, then press “Power/Fire” again (Figure 10).
6. No and HACAL will alternately blink. Press ▲ or ▼ to display yES and CAL, then press “Power/Fire” to begin calibration.
 - o Calibration can be aborted by pressing “Power/Fire” when no and CAL are alternately displayed.

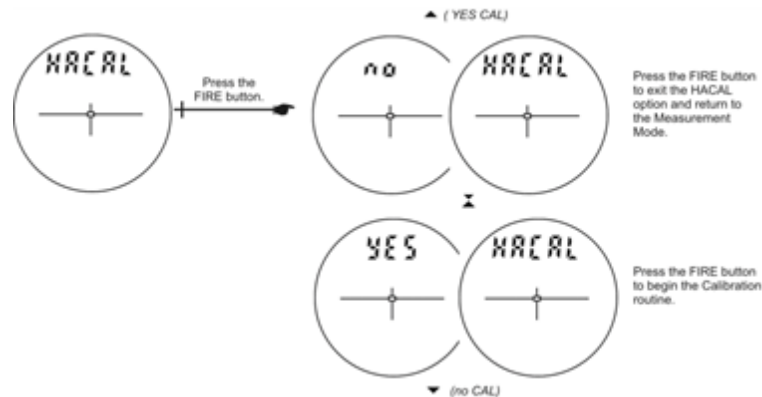

Figure 10. TruPulse 360R Laser Rangefinder viewfinder during compass calibration procedure

7. C1_Fd will be displayed in the view finder.
8. Place the TruPulse 360R Laser Rangefinder facing magnetic North (within 15 deg of N) on a relatively flat surface, or hold it while maintaining it flat (within 15 deg of level). To calibrate the

Title: TOS Protocol and Procedure: Measurement of Vegetation Structure		Date: 10/01/2014
NEON Doc. #: NEON.DOC.000987	Author: C. Meier	Revision: D

compass, follow the sequence outlined in Figure 11 below. The TruPulse 360R Laser Rangefinder provides confirmation after each step.

- a. At each step, wait approximately 1 second before pressing “Power/fire”, then wait another second before moving to the next position. It is important that the unit is held steady when you press “Power/fire”.
- b. To abort and return to previous calibration at any point hold ▲ or ▼ for 4 sec.

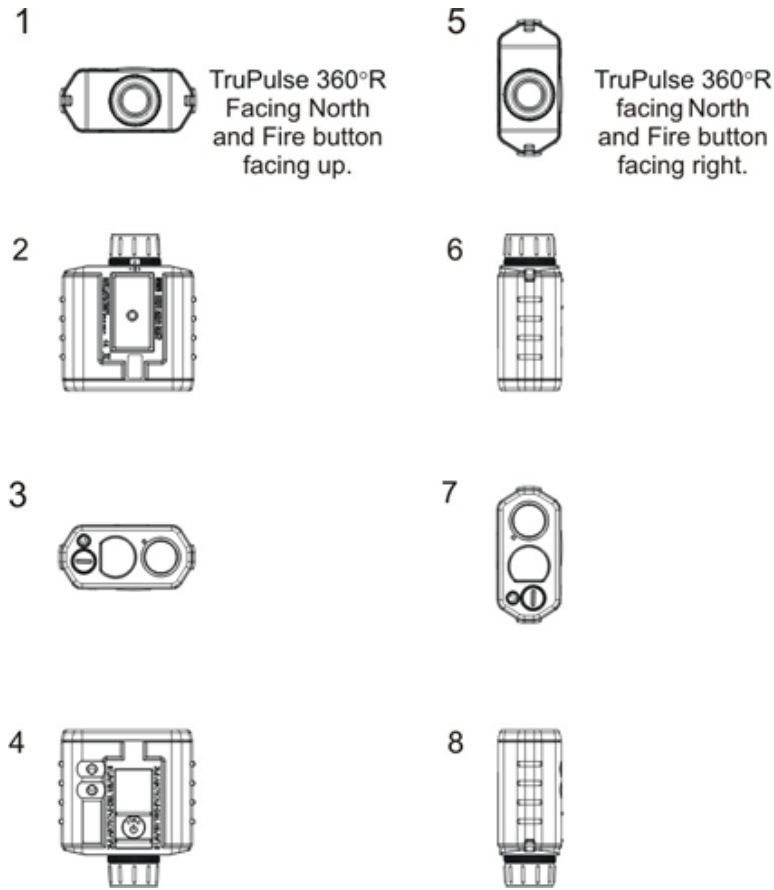

Figure 11. TruPulse 360R Laser Rangefinder compass calibration routine

9. After all 8 positions have been run through, look through the eyepiece. Either a PASS or FAiL message appears in the view finder.
 - a. PASS: Press the “Power/Fire” Button to return to the measurement mode.
 - b. FAiL1: Excessive motion during calibration. Unit was not held steady.
 - c. FAiL2: Magnetic saturation error. Local magnetic field too strong.
 - d. FAiL3: Mathematical fit error.
 - e. FAiL4: Calibration convergence error.
 - f. FAiL6: Orientations were wrong during the calibrations.
10. If FAiL appears, press the “Power/Fire” button. No and CAL will alternately blink allowing you to do a new calibration. If the calibration fails, the unit reverts to the previous calibration.

Title: TOS Protocol and Procedure: Measurement of Vegetation Structure		Date: 10/01/2014
NEON Doc. #: NEON.DOC.000987	Author: C. Meier	Revision: D

D.4 Measuring distance from a known point

1. Press “Power/Fire” to turn on the TruPulse.
2. Set the unit to Target Mode = Filter
 - a. Press ▲ for 4 seconds. The active Target Mode appears in the viewfinder. Press ▲ or ▼ to cycle through available Target Modes. Available Target Modes are:
 - Std = Standard; Single-shot mode. The laser will acquire data from one target.
 - Con = Continuous; In this mode, by pressing and holding “Power/Fire” the unit will acquire a target, and will continue to acquire additional targets for a maximum of 10 s. The most recently acquired target is displayed in the viewfinder. Useful for scanning trees in order to find the highest point.
 - CLO = Closest; Press and hold the “Power/Fire” button in this mode. Once the initial target is acquired, the unit will acquire additional targets. The **MULTI** indicator in the viewfinder denotes additional targets have been acquired. The closest acquired target is displayed in the viewfinder. Useful with narrow targets in the foreground.
 - FAR = Farthest; Identical to CLO above, but the farthest target is displayed in the viewfinder. Useful with a target partially obscured by brush, or for finding the highest point of a tree.
 - Flt = Filter; In this mode, the laser’s sensitivity is reduced to only detect pulses returned from a reflective surface. Useful when attempting to measure targets through thick brush. ***In very heavy brush, the optional foliage filter can be used in this mode, but is not required.*** In this mode, an ‘F’ appears at the left of the viewfinder.
 - b. Choose “Flt” and press “Power/Fire” to make the chosen Target Mode active.
3. Press either the ▲ or ▼ button until **HD** (i.e. Horizontal Distance) appears in the viewfinder.
4. Person 1: Hold the reflective surface at the base of the stem so that it is visible to Person 2.
5. Person 2: Look through the TruPulse viewfinder, aim the crosshairs at the reflective surface held by Person 1, and press and hold “Power/Fire” until the distance is displayed in the viewfinder; record this distance.

D.5 Measuring azimuth from a known point

1. After recording the **HD** to the stem above, press ▲ three times until **AZ** (i.e. azimuth from True North) appears in the viewfinder and the angle in degrees is displayed; record this angle.
2. The angle should be preceded by a “**d**” indicating that declination has been set for the TruPulse at your current location (as described previously).

Title: TOS Protocol and Procedure: Measurement of Vegetation Structure		Date: 10/01/2014
NEON Doc. #: NEON.DOC.000987	Author: C. Meier	Revision: D

D.6 Measuring the canopy diameter of woody stems

1. For individuals with height > approximately 2 m: Use the TruPulse 360R in **HD** (Horizontal Distance) mode.
 - a. Person 1 and Person 2 should position themselves below the edges of the canopy corresponding to either Diameter_max or Diameter_90 above.
 - b. Person 1 should hold a reflective surface, and Person 2 should shoot a **HD** to Person 1 using the TruPulse. Record this distance to the nearest 0.1 meter.
2. For individuals with height < approximately 2 m: Use a meter tape.
 - a. Person 1 and Person 2 stretch a meter tape to measure the desired diameters, and record the distance to the nearest 0.1 meter.

D.7 Measuring the height of woody stems

First measure the vertical distance from the TruPulse to the top of the canopy (this is VD1; this number is typically positive). Next, use the TruPulse to measure the vertical distance from the TruPulse to the base of the stem (this is VD2; this number should be negative, since the base of the stem is typically below the height of the observer's eyes). The height of the stem is then, Height = VD1–VD2.

To start, the TruPulse should be set with Target Mode = Continuous, so that when “Power/Fire” is continuously depressed (for up to 10 s), the observer can scan and search for the **VD** value that represents the highest canopy point or the stem base. It is critical to ascertain that the observed **VD** values are associated with the stem of interest, and not any interfering or background vegetation. In cases where the desired **VD** cannot be measured in Continuous mode (e.g. foliage or branches obstruct the target), set the TruPulse with Target Mode = Farthest (FAR), so that the unit reports **VD** from the furthest laser return from the observer. If the observer is positioned carefully, the furthest return should correspond either to the base of the stem (i.e. the ground) or the highest canopy point.

The steps required to record VD1 and VD2 are as follows:

1. Select a location from which the likely canopy peak(s) and the base of the stem are visible. It is critical that the observer measure both VD1 and VD2 from the same location.
2. Press “Power/Fire” to power on the TruPulse.
3. Set the Target Mode to either Continuous (Con) or Farthest (FAR); use your best judgement as to which mode is most appropriate for the stem of interest. Press ▲ for 4 s, then press ▲ or ▼ until either “Con” or “FAR” is displayed, and press “Power/Fire” to select.
4. Press ▲ or ▼ until **VD** (Vertical Distance) is displayed in the viewfinder.
5. Look through the viewfinder and aim the cross-hairs at what appears to be the highest point of the canopy. If the TruPulse is in Continuous mode, “Power/Fire” may be pressed for up to 10 s, and “Laser” will display in the viewfinder and the **VD** value in the upper-right will update in real-time as the cross-hairs are aimed at targets. When “Laser” disappears, the unit will display the most recent **VD** in the upper-right.

Title: TOS Protocol and Procedure: Measurement of Vegetation Structure		Date: 10/01/2014
NEON Doc. #: NEON.DOC.000987	Author: C. Meier	Revision: D

- a. If it is necessary to move around while locating the highest canopy point, make sure that the base of the stem is still visible from the new location.
 - b. If it is unclear which point in the canopy is the highest, press “Power/Fire” and use the TruPulse to explore potential peaks until the highest point is found. **Once the highest point is located, record this value as VD1.**
6. Look through the viewfinder and aim the cross-hairs at the base of the stem. Press and hold “Power/Fire” for at least 1 s. The **VD** value in the upper-right of the viewfinder should blink when “Power/Fire” is released. **Record this value as VD2.**

D.8 Measuring canopy diameters

Canopy diameter measurements are reported to the nearest 0.1 meter. **canopyDiameterMax** = the diameter at the greatest canopy extent. **canopyDiameter90** = the diameter approximately perpendicular to canopyDiameterMax. Canopy diameters can be measured via either of the following two techniques:

1. *For individuals with height > approximately 2 m:* Use the TruPulse 360R in **HD** (Horizontal Distance) mode.
 - a. Person 1 and Person 2 should position themselves below the edges of the canopy corresponding to either Diameter 1 or Diameter 2 above.
 - b. Person 1 should hold a reflective surface, and Person 2 should shoot a **HD** to Person 1 using the TruPulse. Record this distance to the nearest 0.1 meter.
2. *For individuals with height < approximately 2 m:* Use a meter tape.
 - a. Person 1 and Person 2 stretch a meter tape to measure the desired diameters, and record the distance to the nearest 0.1 meter.

APPENDIX E "OTHER" NON-WOODY, NON-HERBACEOUS VEGETATION

		numberOfLeaves ¹	diameterMax	diameter90	height	basalStemDiameter	avLengthOfLeaf	numberOfPads	Reference
Ferns²	<i>Athyrium filix-femina</i>	x					x		Gholtz et al 1979
	<i>Blechnum spicant</i>	x					x		Gholtz et al 1979
	<i>Dryopteris austriaca</i>	x					x		Gholtz et al 1979
	<i>Polystichum munitum</i>	x					x		Gholtz et al 1979
	<i>Pteridium aquilinum</i>					x			Gholtz et al 1979
	<i>Cyathea sp.</i>				x				Alves et al 2010
Cactus	<i>Opuntia sp.</i>							x	
	<i>Yucca sp.</i>		x	x	x				
	<i>Xerophyllum tenax</i>					x	x		Gholtz et al 1979
	<i>Agave sp.</i>		x	x	x				
Palms	<i>Serenoa repens</i>	x	x	x	x				Schafer 2010
	<i>Sabal etonia</i>	x	x	x	x				Schafer 2010

¹ Use for Frond-bearing species as well

² Fern species not mentioned in this table should be measured similarly to *Athyrium filix-femina*

Title: TOS Protocol and Procedure: Measurement of Vegetation Structure		Date: 10/01/2014
NEON Doc. #: NEON.DOC.000987	Author: C. Meier	Revision: D

APPENDIX F SAFE HANDLING AND MEASUREMENT OF *TOXICODENDRON* SPECIES

The following are best-practice techniques for minimizing exposure to toxic oil during measurement of *Toxicodendron* species.

1. Prior to field work, if *Toxicodendron* is likely to be present in measurement plots:
 - a. Include safe handling equipment (Table 5) in field supplies
 - b. Make sure all field technicians are able to identify *Toxicodendron* species by sight.
2. To handle and measure *Toxicodendron* biomass in the field:
 - Wear cotton gloves and dispose after single use. Toxic oils can pass through nitrile or latex gloves.
 - Wear a thin outer layer of disposable PPE over clothes and shoes.
 - Use a pair of clippers dedicated solely to clipping *Toxicodendron spp* to remove leaves from the measurement area to expose the stem and minimize contact
 - Measure stem diameter with dedicated, labeled calipers.
 - If measuring diameter on a supporting stem > 5 cm DBH, attempt to thread tape under liana stems if possible; if not possible, measure whole diameter (supporting stem + liana) and note in the remarks field (Notes datasheet) how measurement was taken. Use dedicated, labeled DBH tape.
 - Clean all equipment the comes in contact with *Toxicodendron* with Tecnu (or equivalent) after each use. Store separately from other equipment to prevent accidental contact.
 - Bring a clean, new plastic bag to the field for storing and transporting contaminated gloves and clippers after use.
 - After field work is complete, wash clothing according to these guidelines or similar:
 - <http://laundry.about.com/od/removeoutdoorstains/a/poisonivylaundry.htm>

Title: TOS Protocol and Procedure: Measurement of Vegetation Structure		Date: 10/01/2014
NEON Doc. #: NEON.DOC.000987	Author: C. Meier	Revision: D

APPENDIX G PLOT MAP

Plot pointIDs are numbered according to the largest possible plot size, 80 m x 80 m, such that a plot of any size will use a consistent numbering scheme. A pointID has been defined for every 10 m spacing; this design is used in initial plot establishment, but permanent, primary, and secondary markers, are placed at 20 meter intervals. During stem mapping, technicians will only use the points that have permanent markers in place, those identified as bold in this diagram. Plot subplotIDs are determined by the pointID of the SW corner of the subplot area. Plot center will always be pointID 41.

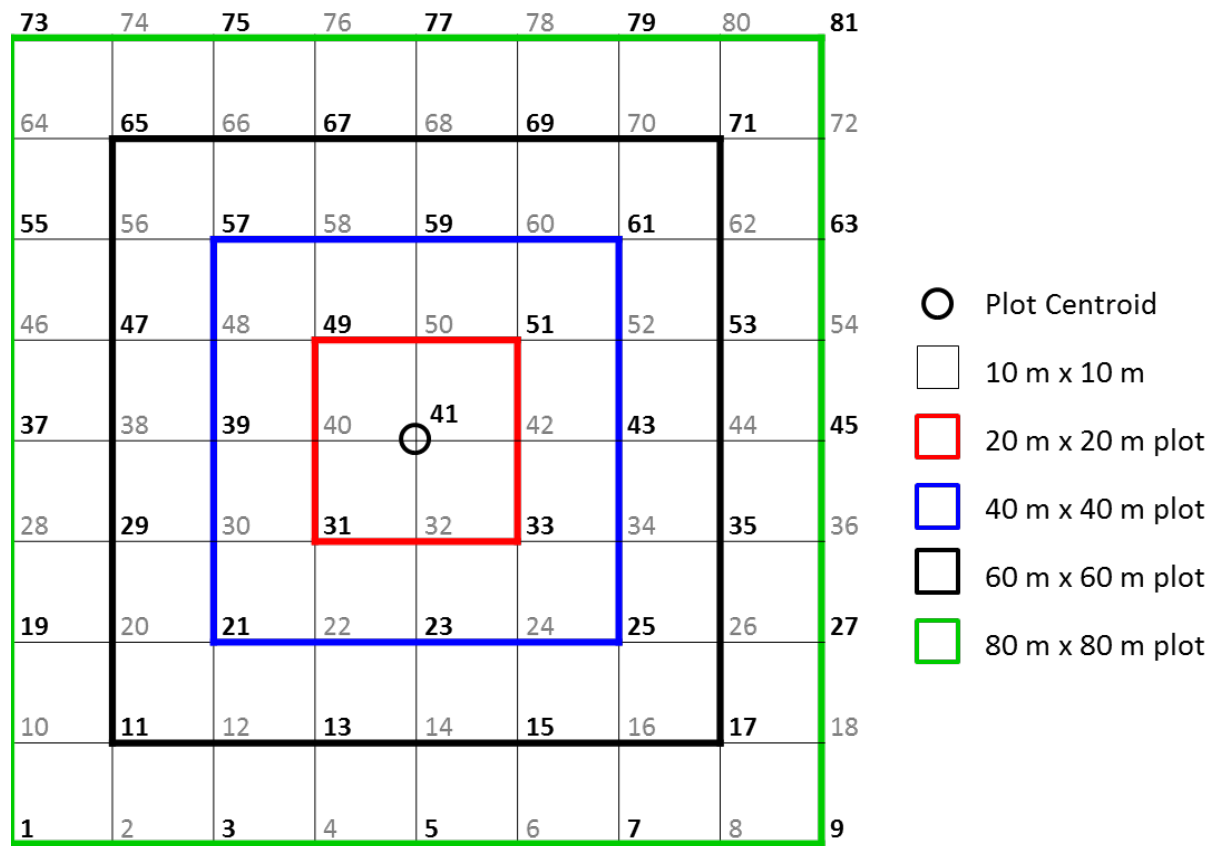

Figure 12. Plot map

Title: TOS Protocol and Procedure: Measurement of Vegetation Structure		Date: 10/01/2014
NEON Doc. #: NEON.DOC.000987	Author: C. Meier	Revision: D

APPENDIX H ESTIMATED DATES FOR ONSET AND CESSATION OF SAMPLING

The dates in Table 14 below are based on historic records and are estimates for the start and stop dates of sampling. It is essential that domain staff monitor real-time conditions to determine when to start (and stop) sampling, as described in Section 4 of this protocol.

“Start Date” and “End Date” fields are relevant to vegetation structure measurement windows in both Distributed and Tower plots, and represent the period of time during which vegetation photosynthetic activity is minimal following a growing season. The “Protocol Implementation” field indicates qualifying vegetation is present in a given plot type at the site level, and therefore the Vegetation Structure protocol should be implemented. It will not necessarily be possible to record vegetation structure data throughout the entire measurement window, due to snow, site access issues, etc. If provided measurement windows are not logistically feasible, changes to “Start Date” may be made in consultation with Science Operations.

All dates in Table 14 are estimated from MODIS-EVI phenology data averaged from 2001-2009. Unless indicated otherwise, “End Date” values are in the next calendar year. All dates are provided in day-of-year format. Site ID values that are bold/italic are sites in Operations in 2014.

See Table 15 for “day-of-year → Gregorian date” conversion data.

Table 14. Site-specific sampling start and end dates for vegetation structure measurements

Domain Number	Site ID	Start Date	End Date	Protocol Implementation by Plot Type	Additional Sampling Information
01	BART	300	120	Dist = Yes Tower = Yes	Access problems may exist during proposed measurement window.
	BURL	315	110	Dist = Yes	
	HARV	300	110	Tower = Yes	Access problems may exist during proposed measurement window.
02	BLAN	310	75	Dist = Yes Tower = Yes	
	SCBI	320	85	Dist = Yes Tower = Yes	
	SERC	325	80	Dist = Yes Tower = Yes	
03	DSNY	320	60	Dist = Yes Tower = No	
	JERC	310	90	Dist = Yes Tower = Yes	
	OSBS	315	70	Dist = Yes Tower = Yes	Not all Distributed plots may have qualifying stems.

Title: TOS Protocol and Procedure: Measurement of Vegetation Structure		Date: 10/01/2014
NEON Doc. #: NEON.DOC.000987	Author: C. Meier	Revision: D

Domain Number	Site ID	Start Date	End Date	Protocol Implementation by Plot Type	Additional Sampling Information
04	GUAN	Any	60d after start	Dist = Yes Tower = Yes	Start Date should be consistent from year to year (\pm 2 weeks).
	LAJA	Any	60d after start	Dist = Yes Tower = Yes	Start Date should be consistent from year to year (\pm 2 weeks).
	MAME	Any	60d after start	Dist = Yes Tower = Yes	Start Date should be consistent from year to year (\pm 2 weeks).
05	STEI	250	120	Dist = Yes Tower = Yes	Not all Tower plots may have qualifying stems.
	TREE	250	120	Dist = Yes Tower = Yes	
	UNDE	285	125	Dist = Yes Tower = Yes	
06	KONA	NA	NA	Dist = No Tower = No	
	KONZ	300	90	Dist = Yes Tower = No	Isolated stems may be encountered in Distributed plots.
	KUFS	330	75	Dist = Yes Tower = Yes	
07	GRSM	310	90	Dist = Yes Tower = Yes	
	MLBS	310	110	Dist = Yes Tower = Yes	
	ORNL	315	90	Dist = Yes Tower = Yes	
08	CHOC	335	70	Dist = Yes Tower = Yes	
	DELA	330	60	Dist = Yes Tower = Yes	
	TALL	330	75	Dist = Yes Tower = Yes	
09	DCFS	290	120	Dist = Yes Tower = No	Isolated stems may be encountered in Distributed plots.
	NOGP	290	115	Dist = Yes Tower = No	Isolated stems may be encountered in Distributed plots.
	WOOD	290	120	Dist = Yes Tower = No	Isolated stems may be encountered in Distributed plots.
10	CPER	350	90	Dist = Yes Tower = No	Isolated stems may be encountered in Distributed plots.

Title: TOS Protocol and Procedure: Measurement of Vegetation Structure		Date: 10/01/2014
NEON Doc. #: NEON.DOC.000987	Author: C. Meier	Revision: D

Domain Number	Site ID	Start Date	End Date	Protocol Implementation by Plot Type	Additional Sampling Information
	RMNP	285	120	Dist = Yes Tower = Yes	
	STER	NA	NA	Dist = No Tower = No	
11	CLBJ	325	60	Dist = Yes Tower = Yes	
	KLEM	NA	NA	Dist = No Tower = No	
	<i>TBD</i>				
12	BOZE	NA	NA	Dist = TBD Tower = TBD	Urban site on college campus.
	PARA	285	105	Dist = Yes Tower = Yes	Isolated stems may be encountered in Distributed and Tower plots.
	YELL	280	120	Dist = Yes Tower = Yes	Access problems may exist during proposed measurement window.
13	MOAB	300	85	Dist = Yes Tower = Yes	Short shrubs, widely spaced; many may not be qualifying stems.
	NIWO	270	140	Dist = Yes Tower = No	Access problems may exist during proposed measurement window.
	<i>TBD</i>				
14	JORN	320	80	Dist = Yes Tower = Yes	
	SRER	330	150	Dist = Yes Tower = Yes	
	<i>TBD</i>				
15	ONAQ	280	75	Dist = Yes Tower = Yes	
	RBUT	310	105	Dist = Yes Tower = Yes	
	<i>TBD</i>				
16	ABBY	300	110	Dist = Yes Tower = Yes	Not all plots may have qualifying stems.
	THAY	300	110	Dist = Yes Tower = Yes	
	WREF	290	115	Dist = Yes Tower = Yes	
17	SJER	155	270	Dist = Yes Tower = Yes	
	SOAP	290	90	Dist = Yes Tower = Yes	

Title: TOS Protocol and Procedure: Measurement of Vegetation Structure		Date: 10/01/2014
NEON Doc. #: NEON.DOC.000987	Author: C. Meier	Revision: D

Domain Number	Site ID	Start Date	End Date	Protocol Implementation by Plot Type	Additional Sampling Information
	TEAK	300	120	Dist = Yes Tower = Yes	Access problems may exist during proposed measurement window.
18	BARO	NA	NA	Dist = No Tower = No	Isolated qualifying stems may exist.
	TOOL	240	160	Dist = Yes Tower = Yes	Abundant shrub-scrub vegetation. Access problems may exist during proposed measurement window.
	<i>TBD</i>				
19	DEJU	250	130	Dist = Yes Tower = Yes	Access problems may exist during proposed measurement window.
	HEAL	245	135	Dist = Yes Tower = Yes	Abundant shrub-scrub vegetation. Access problems may exist during proposed measurement window.
	POKE	250	135	Dist = Yes Tower = Yes	Access problems may exist during proposed measurement window.
20	OLAA	Any	60d after start	Dist = Yes Tower = Yes	Start Date should be consistent from year to year (± 2 weeks).
	PUFO	Any	60d after start	Dist = Yes Tower = Yes	Start Date should be consistent from year to year (± 2 weeks).
	PUGR	Any	60d after start	Dist = Yes Tower = Yes	Start Date should be consistent from year to year (± 2 weeks).

Table 15. Day-of-year calendar for non-leap years

Day	Jan	Feb	Mar	Apr	May	Jun	Jul	Aug	Sep	Oct	Nov	Dec	Day
1	001	032	060	091	121	152	182	213	244	274	305	335	1
2	002	033	061	092	122	153	183	214	245	275	306	336	2
3	003	034	062	093	123	154	184	215	246	276	307	337	3
4	004	035	063	094	124	155	185	216	247	277	308	338	4
5	005	036	064	095	125	156	186	217	248	278	309	339	5
6	006	037	065	096	126	157	187	218	249	279	310	340	6
7	007	038	066	097	127	158	188	219	250	280	311	341	7
8	008	039	067	098	128	159	189	220	251	281	312	342	8
9	009	040	068	099	129	160	190	221	252	282	313	343	9
10	010	041	069	100	130	161	191	222	253	283	314	344	10
11	011	042	070	101	131	162	192	223	254	284	315	345	11
12	012	043	071	102	132	163	193	224	255	285	316	346	12
13	013	044	072	103	133	164	194	225	256	286	317	347	13
14	014	045	073	104	134	165	195	226	257	287	318	348	14
15	015	046	074	105	135	166	196	227	258	288	319	349	15
16	016	047	075	106	136	167	197	228	259	289	320	350	16
17	017	048	076	107	137	168	198	229	260	290	321	351	17
18	018	049	077	108	138	169	199	230	261	291	322	352	18
19	019	050	078	109	139	170	200	231	262	292	323	353	19
20	020	051	079	110	140	171	201	232	263	293	324	354	20
21	021	052	080	111	141	172	202	233	264	294	325	355	21
22	022	053	081	112	142	173	203	234	265	295	326	356	22
23	023	054	082	113	143	174	204	235	266	296	327	357	23
24	024	055	083	114	144	175	205	236	267	297	328	358	24
25	025	056	084	115	145	176	206	237	268	298	329	359	25
26	026	057	085	116	146	177	207	238	269	299	330	360	26
27	027	058	086	117	147	178	208	239	270	300	331	361	27
28	028	059	087	118	148	179	209	240	271	301	332	362	28
29	029		088	119	149	180	210	241	272	302	333	363	29
30	030		089	120	150	181	211	242	273	303	334	364	30
31	031		090		151		212	243		304		365	31