

|  |                         |                        |
|--|-------------------------|------------------------|
| <i>Title:</i> TOS Protocol and Procedure: Plant Belowground Biomass Sampling |                         | <i>Date:</i> 01/22/219 |
| <i>NEON Doc. #:</i> NEON.DOC.014038  | <i>Author:</i> C. Meier | <i>Revision:</i> G     |

## TOS PROTOCOL AND PROCEDURE: PLANT BELOWGROUND BIOMASS SAMPLING

| <b>PREPARED BY</b> | <b>ORGANIZATION</b> | <b>DATE</b> |
|--------------------|---------------------|-------------|
| Courtney Meier     | SCI                 | 12/11/2018  |

| <b>APPROVALS</b> | <b>ORGANIZATION</b> | <b>APPROVAL DATE</b> |
|------------------|---------------------|----------------------|
| Kate Thibault    | SCI                 | 01/22/2019           |
| Mike Stewart     | PSE                 | 01/18/2019           |
|                  |                     |                      |
|                  |                     |                      |

| <b>RELEASED BY</b> | <b>ORGANIZATION</b> | <b>RELEASE DATE</b> |
|--------------------|---------------------|---------------------|
| Anne Balsley       | CM                  | 01/22/2019          |

See configuration management system for approval history.

The National Ecological Observatory Network is a project solely funded by the National Science Foundation and managed under cooperative agreement by Battelle. Any opinions, findings, and conclusions or recommendations expressed in this material are those of the author(s) and do not necessarily reflect the views of the National Science Foundation.

|   |                  |                 |
|---|------------------|-----------------|
| Title: TOS Protocol and Procedure: Plant Belowground Biomass Sampling |                  | Date: 01/22/219 |
| NEON Doc. #: NEON.DOC.014038  | Author: C. Meier | Revision: G     |

## Change Record

| REVISION | DATE       | ECO #     | DESCRIPTION OF CHANGE   |
|----------|------------|-----------|---|
| A        | 03/25/2011 | ECO-00148 | Initial release   |
| B        | 01/20/2015 | ECO-02273 | Production release, template change, method improvements  |
| C        | 02/26/2015 | ECO-02702 | Migration to new protocol template  |
| D        | 1/28/2016  | ECO-03547 | <p>Major changes to protocol include:</p> <ul style="list-style-type: none"> <li>• All SOPs now implemented together every time protocol is executed, previously SOP D implemented 1X per site</li> <li>• Timing information updated, and preservation of cores prior to core processing eliminated.</li> <li>• Equipment list updates for lab work</li> <li>• SOP C.1 sieving methods updated based on megapit sampling experience</li> <li>• Roots from 2 cores within a clipCell are now pooled <i>after</i> weighing takes place and prior to grinding for chemical analysis / archive.</li> <li>• “other” non-root biomass no longer quantified</li> <li>• Method for calculating core `storageHours` now consistent with Herbaceous Biomass protocol.</li> <li>• Updated Sample Shipment procedure (SOP F) to be consistent with Herbaceous Biomass protocol.</li> <li>• To aid co-locating herbaceous clip and fine root coring, added maps of clip cells within plots to appendix G.</li> <li>• References to mini-rhizotrons removed after descope.</li> </ul> |
| E        | 02/17/2017 | ECO-04403 | <ul style="list-style-type: none"> <li>• Added table of common terms and definitions to Section 2.4</li> <li>• Toxicodendron material condensed and removed when possible, now reference RD[12]</li> <li>• Added ‘Estimated Time’ required for protocol sub-tasks to Section 6.4 based on Field Ops experience.</li> <li>• Updated field and lab equipment list based on feedback from Field Ops prototype.</li> <li>• SOP B: Added ‘Linked Protocol’ call-out box to highlight connection with Herbaceous Biomass.</li> </ul>  |

|   |                  |                 |
|---|------------------|-----------------|
| Title: TOS Protocol and Procedure: Plant Belowground Biomass Sampling |                  | Date: 01/22/219 |
| NEON Doc. #: NEON.DOC.014038  | Author: C. Meier | Revision: G     |

| REVISION | DATE       | ECO #     | DESCRIPTION OF CHANGE   |
|----------|------------|-----------|---|
|          |            |           | <ul style="list-style-type: none"> <li>• SOP B: Added `coringPossible` to better document sample collection effort, and added `coreDiameter` to allow future changes in equipment.</li> <li>• SOP C: Cores may be soaked overnight prior to wet-seiving.</li> <li>• SOP C: Added instructions for using the wire gauge properly to sort roots by diameter.</li> <li>• SOP C: Simplified pooling instructions, and changed minimum mass of pooled sample from 0.250 g to 0.02 g; removed grinding of samples &lt; 1 g (change from 0.75 g).</li> <li>• SOP C/D: Changed all mass measurement requirements to grams, rather than mix of grams and milligrams.</li> <li>• SOP C/D: Changed timing to allow for overnight pause between SOP C and SOP D.</li> <li>• SOP D: Clarified that `sampleVolume` and `subsampleVolume` can be adjusted on a per core basis to optimize root material mass for sorting.</li> <li>• SOP D: Clarified anticipated effort for sorting root/OM aliquots.</li> <li>• Appendix D: Changed dates from DOY to MM/DD format, and updated Ops-IPT approved missing dates.</li> </ul> |
| F        | 05/17/2018 | ECO-05595 | <ul style="list-style-type: none"> <li>• Section 3.1: New section to explicitly call out integration of Belowground Biomass sampling with Herbaceous Clip Harvest.</li> <li>• Section 4.1 and 4.2, Frequency and Timing: Re-organized and simplified to emphasize important scheduling and timing criteria.</li> <li>• Section 6.1, Equipment: Clarified that balances with 0.001 or 0.0001 g accuracy are needed for SOP D; added updated stir-plates or SOP D.</li> <li>• Section 6.4, Estimated Time: Removed labor allocation guidelines, added Table 7 with updated estimated labor per SOP.</li> <li>• SOP B.1: Re-organized workflow to include sample collection method assessment, and added ability to collect a monolith sample type.</li> <li>• SOP B.1: Specified that distance to closest woody stem applies to living stems.</li> <li>• SOP B.2: Split out 'Troubleshooting' into its own section, consistent with Herbaceous Biomass protocol.</li> </ul>   |

|   |                  |                  |
|---|------------------|------------------|
| Title: TOS Protocol and Procedure: Plant Belowground Biomass Sampling |                  | Date: 01/22/2019 |
| NEON Doc. #: NEON.DOC.014038  | Author: C. Meier | Revision: G      |

| REVISION | DATE       | ECO #     | DESCRIPTION OF CHANGE  |
|----------|------------|-----------|--|
|          |            |           | <ul style="list-style-type: none"> <li>• SOP B.5: New section detailing modified field sampling layout at agricultural sites.</li> <li>• SOP C: Re-wrote wet-sieving procedure based on domain staff feedback.</li> <li>• SOP C.1: Added guidance for clipping branched root systems according to size category.</li> <li>• SOP C.2: Clarified that Oven Start/End Dates/Times are only needed for initial drying, not additional drying after storage.</li> <li>• SOP C.4: Updated text and Table 11 with 40-mesh grinding guidance for C:N analysis subsample.</li> <li>• SOP D: New criteria for selecting soil samples for dilution sampling (spatially balanced approach).</li> <li>• SOP F: Updated to reference digital shipment creation and tracking tools.</li> <li>• Multiple sections: Updated text to reflect digital workflow and mobile app structure.</li> <li>• Multiple sections: Added barcoding workflow required for pooled samples shipped for external analysis; optional for other stages of sample collection and processing.</li> <li>• Added Appendix E: Site-specific modifications necessary to aid with consistent sample collection in D18/19.</li> </ul> |
| G        | 01/22/2019 | ECO-05985 | <ul style="list-style-type: none"> <li>• Section 6.1: Added metal weigh pans and glass scint vials to equipment list as an option when static is problematic.</li> <li>• Section 6.4: Changed estimated grinding hours from 8 h to 32 h, updated core sorting hours to 1-10 h per sample.</li> <li>• SOP B/C: New movable label workflow from Field to Lab.</li> <li>• SOP B.2: Added photo of frame method for delineating soil sample collection area.</li> <li>• SOP B.2: Added example label text.</li> <li>• Section 5, SOP B, and SOP C: Added guidance for identifying and processing root samples that may contain <i>Toxicodendron spp.</i></li> <li>• SOP C.1.1: Added ability to pause overnight between sieving and sorting provided conditions are met.</li> <li>• SOP C.1.1: Added photos of sorting container and live vs. dead roots from training materials.</li> <li>• SOP C.1.1: Added illustration of wet-sieving process.</li> </ul>  |

|   |                  |                 |
|---|------------------|-----------------|
| Title: TOS Protocol and Procedure: Plant Belowground Biomass Sampling |                  | Date: 01/22/219 |
| NEON Doc. #: NEON.DOC.014038  | Author: C. Meier | Revision: G     |

| REVISION | DATE | ECO # | DESCRIPTION OF CHANGE  |
|----------|------|-------|--|
|          |      |       | <ul style="list-style-type: none"> <li>• SOP C.1.1: Added example label text.</li> <li>• SOP C.4: Added guidance to prepare root samples prior to grinding to improve milling performance.</li> <li>• SOP C.5: Added Wiley Mill maintenance guidance.</li> <li>• SOP D: Clarified dilution sample number when number of Tower plots is &lt; 20.</li> <li>• SOP F and Appendix G: Added shipping and labeling guidelines for chemical analysis for samples containing <i>Toxicodendron</i>.</li> <li>• Appendix B: Changed from 'Reminders' to 'Sampling QC Checklist'</li> <li>• Appendix E: D19 DEJU modification to use core method despite rock layer at ~25 cm depth.</li> </ul> |

|  |                         |                        |
|--|-------------------------|------------------------|
| <i>Title:</i> TOS Protocol and Procedure: Plant Belowground Biomass Sampling |                         | <i>Date:</i> 01/22/219 |
| <i>NEON Doc. #:</i> NEON.DOC.014038  | <i>Author:</i> C. Meier | <i>Revision:</i> G     |

**TABLE OF CONTENTS**

**1 OVERVIEW .....6**

1.1 Background ..... 6

1.2 Scope..... 7

1.2.1 NEON Science Requirements and Data Products ..... 7

1.3 Acknowledgments..... 7

**2 RELATED DOCUMENTS AND ACRONYMS .....7**

2.1 Applicable Documents ..... 7

2.2 Reference Documents..... 8

2.3 Acronyms ..... 8

2.4 Definitions..... 9

**3 METHOD .....9**

3.1 Integrating Plant Belowground Biomass and Herbaceous Biomass Sampling ..... 3

**4 SAMPLING SCHEDULE .....4**

4.1 Sampling Frequency and Scheduling ..... 4

4.2 Criteria for Determining Onset of Sampling ..... 6

4.3 Sampling Timing Contingencies ..... 7

4.4 Criteria for Reallocation of Sampling Within a Site ..... 7

**5 SAFETY .....8**

**6 PERSONNEL AND EQUIPMENT.....10**

6.1 Equipment..... 10

6.2 Training Requirements..... 24

6.3 Specialized Skills..... 24

6.4 Estimated Personnel Hours..... 25

**7 STANDARD OPERATING PROCEDURES.....26**

**SOP A PREPARING FOR SAMPLING.....26**

A.1 Sample Labels and Identifiers ..... 26

A.2 Preparing for plant belowground biomass sampling in the field (SOP B)..... 27

A.3 Preparing for processing soil samples in the laboratory (SOP C)..... 30

A.4 Preparing for dilution sampling for fine root fragments (SOP D) ..... 30

|   |                  |                 |
|---|------------------|-----------------|
| Title: TOS Protocol and Procedure: Plant Belowground Biomass Sampling |                  | Date: 01/22/219 |
| NEON Doc. #: NEON.DOC.014038  | Author: C. Meier | Revision: G     |

**SOP B PLANT BELOWGROUND BIOMASS SOIL SAMPLING IN THE FIELD.....32**

B.1 Spatially Linked Protocols ..... 32

B.2 Soil Sample Collection..... 33

B.3 Troubleshooting..... 40

B.4 Sample Preservation ..... 41

B.5 Plant Belowground Biomass at Agricultural Sites..... 41

**SOP C PROCESSING BELOWGROUND BIOMASS SAMPLES IN THE LABORATORY .....43**

C.1 Sieving soil samples for fine root biomass..... 44

C.1.1 ..... 44

C.2 Drying, weighing, and processing belowground biomass samples..... 54

C.3 Data Quality Assurance ..... 57

C.4 Grinding and Pooling Biomass for Chemical Analysis and Archive ..... 58

C.5 Equipment maintenance..... 62

**SOP D DILUTION SAMPLING FOR FINE ROOT FRAGMENTS .....64**

**SOP E DATA ENTRY AND VERIFICATION .....71**

E.1 Digital Data Workflow ..... 71

E.2 Field Datasheets..... 72

E.3 Lab Datasheets..... 72

**SOP F SAMPLE SHIPMENT .....73**

F.1 Shipment Preparation Procedure ..... 73

F.2 Laboratory Contact Information and Shipping / Receipt Days ..... 74

**8 REFERENCES .....74**

**APPENDIX A DATASHEETS .....75**

**APPENDIX B SAMPLING QC CHECKLIST .....76**

B.1 Collecting Soil Samples in the Field..... 76

B.2 Processing Belowground Biomass Samples in the Laboratory ..... 76

B.3 Dilution Sampling for Fine Root Fragments..... 77

**APPENDIX C ESTIMATED DATES FOR ONSET AND CESSATION OF SAMPLING .....78**

**APPENDIX D SITE-SPECIFIC MODIFICATIONS .....80**

D.1 D18/19 Site-specific Modifications..... 80

|  |                         |                        |
|--|-------------------------|------------------------|
| <i>Title:</i> TOS Protocol and Procedure: Plant Belowground Biomass Sampling |                         | <i>Date:</i> 01/22/219 |
| <i>NEON Doc. #:</i> NEON.DOC.014038  | <i>Author:</i> C. Meier | <i>Revision:</i> G     |

|                   |   |           |
|-------------------|---|-----------|
| <b>APPENDIX E</b> | <b>SOIL CORE ASSEMBLY .....</b>                               | <b>82</b> |
| <b>APPENDIX F</b> | <b>MANAGING EXPOSURE TO <i>TOXICODENDRON</i> SPECIES.....</b> | <b>83</b> |
| <b>APPENDIX G</b> | <b>CLIPCELLNUMBER COORDINATES AND MAPS.....</b>               | <b>85</b> |
| G.1               | Maps of clipCellNumber by subplotID .....                     | 85        |
| G.2               | Coordinates for clipCellNumbers by subplotID.....             | 90        |



|   |                  |                 |
|---|------------------|-----------------|
| Title: TOS Protocol and Procedure: Plant Belowground Biomass Sampling |                  | Date: 01/22/219 |
| NEON Doc. #: NEON.DOC.014038  | Author: C. Meier | Revision: G     |

**LIST OF TABLES AND FIGURES**

**Table 1.** Definitions for common terms used throughout the Core Sampling for Plant Belowground Biomass protocol. .... 9

**Table 2.** Sampling frequency for plant belowground biomass sampling procedures on a per SOP per plot type basis. .... 4

**Table 3.** Contingency decisions for plant belowground biomass sampling..... 7

**Table 4.** SOP B equipment list – Sampling plant belowground biomass in the field..... 10

**Table 5.** SOP C equipment list – Sieving belowground biomass cores, separating roots from soil organic matter, drying root samples, and processing root samples for shipment. Equipment listed is for 3 people working independently at a root washing station. .... 16

**Table 6.** SOP D equipment list – Dilution sampling for fine root biomass fragments < 1 cm ..... 21

**Table 7.** Estimated staff and labor hours required for implementation of Plant Belowground Biomass Sampling SOPs..... 25

**Table 8.** Soil core bits and the soil types and conditions in which they should be used..... 28

**Table 9.** Actions required to prepare equipment and materials for belowground biomass soil sampling in the field (SOP B). Equipment listed here are only those items that require preparation actions before sampling; the full equipment list is provided in **Table 4**..... 29

**Table 10.** Potential issues encountered during plant Belowground Biomass Core sampling, and issue resolution..... 40

**Table 11.** Splitting and processing guidelines for fine root samples, based on pooled sample mass..... 59

**Table 12.** Datasheets associated with this protocol..... 75

**Table 13.** Estimated average dates after which greenness begins to decrease for each NEON site based on MODIS-EVI phenology data. Ideally, soil core sampling and aboveground biomass clip harvests should occur on or near these dates. .... 78

**Table 14.** Summary of site-specific belowground biomass sampling modifications and supporting rationale..... 80

**Table 15.** Equipment list – Minimizing exposure to toxic oils from roots of *Toxicodendron spp.* that may be encountered during plant Belowground Biomass Sampling. .... 83

**Table 16.** List of clipCellNumbers by subplotID and associated easting and northing coordinates. Coordinates correspond to the SW corner of a 0.1m x 2m Clip Strip, and indicate the distance in meters relative to the SW corner of the plot (subplotID = 31) or subplot (subplotID = 21, 23, 39, 41). .... 90

**Figure 1.** Illustration of two NEON plot sizes used for plant belowground biomass soil sampling..... 1

**Figure 2.** A 20m x 20m Tower Plot showing the locations of 3.0m x 0.5m sampling cells used for plant belowground biomass soil sampling (*left*); Within a cell selected for soil sampling, one soil sample is collected from each of the 0.5m x 0.5m areas to the North and South of the clip-strip (*right*). .... 2

**Figure 3.** Workflow for generating unique identifiers for samples, subsamples, etc. for a clip cell from which soils are collected in the field..... 26

|   |                  |                 |
|---|------------------|-----------------|
| Title: TOS Protocol and Procedure: Plant Belowground Biomass Sampling |                  | Date: 01/22/219 |
| NEON Doc. #: NEON.DOC.014038  | Author: C. Meier | Revision: G     |

**Figure 4.** Label template that can be printed on weather-proof, adhesive labels and applied to field sample bags prior to field sampling (*left*). Example label illustrating information supplied in the field in red (*right*)..... 27

**Figure 5.** Assembled plunger used to randomize root fragment samples < 1 cm length as part of dilution sampling (SOP D)..... 31

**Figure 6.** Delineating the South root sampling area (cross hatched) within a sampling cell (dashed blue lines) with pin flags (*left*). The sampling area may also be delineated using a 50cm x 50cm PVC frame (*right*). ..... 35

**Figure 7.** Delineating the North root sampling area with reference to the previously delineated South root sampling area (cross hatched) within a sampling cell using pin flags..... 35

**Figure 8.** Modified sampling cell layout when integrating plant belowground biomass sampling and herbaceous biomass clip harvest at agricultural sites ..... 42

**Figure 9.** Manual removal of large roots from the surface of the soil sample slurry, followed by transfer from the 2 mm sieve to the sorting tray..... 45

**Figure 10.** Example of a plastic bin sorting container with a small amount of water to aid root separation. .... 45

**Figure 11.** Wet-sieving the soil sample slurry (*step 2e*) followed by decanting the 250 µm sieve contents to separate organic material and roots ≥ 1 cm length from mineral soil (*step 2f*). Mineral soil remains in the decanting tray, and roots and organic material are transferred to the sorting tray (*step 2g*). ..... 46

**Figure 12.** Example of a dead root (*left*) and a live root (*right*)..... 48

**Figure 13.** Clipping a branched root system to Size Category ..... 48

**Figure 14.** Wiley Mini Mill diagram showing position of stationary blade adjustment and clamping screws. .... 63

**Figure 15.** Example of sorting fine root fragments from a dilution subsample (*left*) into a clean ‘root’ tin (*right*) ..... 69

**Figure 16.** Ten pairs of labeled aluminum weighing tins for separating roots from OM ..... 69

**Figure 17.** Component parts of the Giddings soil core assembly. .... 82

**Figure 18.** Map of clipCellNumbers in a 20m x 20m base plot (subplotID = 31 in provided Clip Lists)..... 85

**Figure 19.** Map of clipCellNumbers for subplotID = 21 in a 40m x 40m Tower base plot ..... 86

**Figure 20.** Map of clipCellNumbers for subplotID = 23 in a 40m x 40m Tower base plot ..... 87

**Figure 21.** Map of clipCellNumbers for subplotID = 39 in a 40m x 40m Tower base plot ..... 88

**Figure 22.** Map of clipCellNumbers for subplotID = 41 in a 40m x 40m Tower base plot ..... 89

|   |                  |                 |
|---|------------------|-----------------|
| Title: TOS Protocol and Procedure: Plant Belowground Biomass Sampling |                  | Date: 01/22/219 |
| NEON Doc. #: NEON.DOC.014038  | Author: C. Meier | Revision: G     |

## 1 OVERVIEW

### 1.1 Background

Belowground biomass represents a substantial component of the total plant biomass and plant carbon in terrestrial ecosystems, yet belowground biomass stocks and turnover remain very poorly understood both in space and in time. This is in large part due to the inherent difficulties associated with measuring plant parts that are obscured within soil. Developing a better understanding of how much belowground plant biomass there is, as well as how much of that biomass is produced and decomposed within a given year, is therefore important with respect to improving our understanding of how terrestrial ecosystems respond to environmental changes. Here, we define fine roots to be roots with diameter  $\leq 10$  mm (Burton and Pregitzer 2008). In combination with the belowground biomass soil pit sampling conducted during site construction (RD[09]), the plant belowground biomass sampling described here will enable estimation of the amount of belowground plant biomass  $\leq 10$  mm diameter within the same landsurface area from which NEON Tower eddy covariance data are derived; at many sites this will also be the dominant vegetation type(s).

Fine root frequency, biomass, and turnover rates differ substantially across size classes. In general, larger size classes constitute more of the biomass than smaller size classes, but larger roots also turn over much more slowly and therefore contribute less to annual belowground net primary productivity (BNPP) than fine roots do (Steinaker and Wilson 2005, Tierney and Fahey 2007). NEON employs the most common and robust method to measure belowground biomass in both forest and grassland ecosystems: collection of relatively large diameter soil cores (5–10 cm) or similarly sized monoliths (Tierney and Fahey 2007, Burton and Pregitzer 2008). Because large coarse roots occur infrequently in the soil, higher volume samples result in more accurate estimates of belowground biomass (Taylor et al. 2013). However, large sample volumes require a significant amount of time to sieve and sort in the laboratory. Given that time is limiting, there is therefore an inherent trade-off between the number and size of samples that must be resolved (Berhongaray et al. 2013). For belowground biomass sampling, NEON typically uses a 76.2 mm (3-inch) outside diameter coring device with 66.5 mm (2.6-inch) inside diameter. Samples collected to 30 cm maximum depth in order to be consistent with the sampling depth used for soil biogeochemistry and microbe sampling (RD[07]). Monolith sampling is utilized when soil conditions prevent collecting a core of sufficient depth (e.g., in rocky soils). Within each sampling “cell” selected for belowground biomass sampling, two soil samples are typically collected, for a total minimum sample volume of 2722 cm<sup>3</sup> per sampling cell. If roots up to 10 mm diameter exist at the site, sample volumes of this size should be sufficient to encounter them in the majority of soil samples (Taylor et al. 2013).

To account for differences in BNPP across the spectrum of fine root diameters, researchers typically sort roots within soil samples into various size categories, and then calculate fine root production separately for each size category. Following Burton and Pregitzer (2008), NEON sorts roots within each soil sample to the following **sizeCategory** bins: < 0.5 mm, 0.5–1 mm, 1–2 mm, and 2–10 mm.

|  |                         |                        |
|--|-------------------------|------------------------|
| <i>Title:</i> TOS Protocol and Procedure: Plant Belowground Biomass Sampling |                         | <i>Date:</i> 01/22/219 |
| <i>NEON Doc. #:</i> NEON.DOC.014038  | <i>Author:</i> C. Meier | <i>Revision:</i> G     |

Soil samples are sieved to remove soil, picked to separate roots from other organic material, and roots are then sorted to diameter size category. Picking and sorting roots is time consuming, and similar to other researchers, NEON uses a 1 cm length cutoff to limit the time spent searching for small root fragments – i.e., root fragments < 1 cm length are ignored and discarded for most soil samples. However, root fragments < 1 cm length can contribute > 50% of the total root biomass in some ecosystems (Koteen and Baldocchi 2013). To account for the biomass of root fragments < 1 cm length, NEON employs a dilution technique on a subsample of 20 cores/monoliths every time fine root sampling occurs.

## 1.2 Scope

This document provides a change-controlled version of Observatory protocols and procedures. Documentation of content changes (i.e. changes in particular tasks or safety practices) will occur via this change-controlled document, not through field manuals or training materials.

### 1.2.1 NEON Science Requirements and Data Products

This protocol fulfills Observatory science requirements that reside in NEON’s Dynamic Object-Oriented Requirements System (DOORS). Copies of approved science requirements have been exported from DOORS and are available in NEON’s document repository, or upon request.

Execution of this protocol procures samples and/or generates raw data satisfying NEON Observatory scientific requirements. These data and samples are used to create NEON data products, and are documented in the NEON Scientific Data Products Catalog (RD[03]).

## 1.3 Acknowledgments

The author is grateful for time and detailed advice provided by Daniel Milchunas and Mark Lindquist at the Shortgrass Steppe LTER program. In addition, SOP D “Dilution Sampling for Fine Root Biomass Fragments” is based on the work of Koteen and Baldocchi (2013). Many thanks to: Tamara Hillman for testing equipment and developing ‘movable label’ workflow; Kenny McMahon for improving the text describing the sieving and decanting workflow in SOP C.1.1.

## 2 RELATED DOCUMENTS AND ACRONYMS

### 2.1 Applicable Documents

Applicable documents contain higher-level information that is implemented in the current document. Examples include designs, plans, or standards.

|        |                 |   |
|--------|-----------------|---|
| AD[01] | NEON.DOC.004300 | EHSS Policy, Program and Management Plan          |
| AD[02] | NEON.DOC.004316 | Operations Field Safety and Security Manual       |
| AD[03] | NEON.DOC.000724 | Domain Chemical Hygiene Plan and Biosafety Manual |

|   |                  |                 |
|---|------------------|-----------------|
| Title: TOS Protocol and Procedure: Plant Belowground Biomass Sampling |                  | Date: 01/22/219 |
| NEON Doc. #: NEON.DOC.014038  | Author: C. Meier | Revision: G     |

|        |                 |  |
|--------|-----------------|--|
| AD[04] | NEON.DOC.050005 | Field Operations Job Instruction Training Plan         |
| AD[05] | NEON.DOC.000914 | NEON Science Design for Plant Biomass and Productivity |
| AD[06] | NEON.DOC.004104 | NEON Science Performance QA/QC Plan                    |

## 2.2 Reference Documents

Reference documents contain information that supports or complements the current document. Examples include related protocols, datasheets, or general-information references.

|        |                 |  |
|--------|-----------------|--|
| RD[01] | NEON.DOC.000008 | NEON Acronym List  |
| RD[02] | NEON.DOC.000243 | NEON Glossary of Terms   |
| RD[03] | NEON.DOC.002652 | NEON Level 1, Level 2 and Level 3 Data Products Catalog                                  |
| RD[04] | NEON.DOC.001271 | AOS/TOS Protocol and Procedure: Data Management  |
| RD[05] | NEON.DOC.002135 | Datasheets for TOS Protocol and Procedure: Core Sampling for Plant Belowground Biomass   |
| RD[06] | NEON.DOC.001925 | NEON Raw Data Ingest Workbook for TOS Belowground Biomass Soil Sampling                  |
| RD[07] | NEON.DOC.014048 | TOS Protocol and Procedure: Soil Biogeochemical and Microbial Measurements               |
| RD[08] | NEON.DOC.000987 | TOS Protocol and Procedure: Measurement of Vegetation Structure                          |
| RD[09] | NEON.DOC.001708 | TOS Protocol and Procedure: Soil Pit Sampling for Plant Belowground Biomass              |
| RD[10] | NEON.DOC.001717 | TOS Standard Operating Procedure: TruPulse Rangefinder Use and Calibration               |
| RD[11] | NEON.DOC.014037 | TOS Protocol and Procedure: Measurement of Herbaceous Biomass                            |
| RD[12] | NEON.DOC.001716 | TOS Standard Operating Procedure: Toxicodendron Biomass and Handling                     |
| RD[13] | NEON.DOC.001710 | TOS Protocol and Procedure: Litterfall and Fine Woody Debris                             |
| RD[14] | NEON.DOC.001024 | TOS Protocol and Procedure: Canopy Foliage Chemistry and Leaf Mass per Area Measurements |

## 2.3 Acronyms

| Acronym | Definition                           |
|---------|--------------------------------------|
| BNPP    | Belowground net primary productivity |
| OM      | Organic material                     |

|   |                  |                 |
|---|------------------|-----------------|
| Title: TOS Protocol and Procedure: Plant Belowground Biomass Sampling |                  | Date: 01/22/219 |
| NEON Doc. #: NEON.DOC.014038  | Author: C. Meier | Revision: G     |

## 2.4 Definitions

Common terms used throughout this document are defined here, in alphabetical order.

**Table 1.** Definitions for common terms used throughout the Core Sampling for Plant Belowground Biomass protocol.

| Term              | Definition  |
|-------------------|---|
| clip list         | A randomized list of clip cells for each 20m x 20m plot or subplot, provided by NEON Science. Working down the list through time ensures that selected sampling locations will generate an unbiased estimate of plant belowground biomass for every bout.   |
| clip strip        | A 2.0m x 0.1m rectangular area, typically centered within each clip cell, that is avoided during plant belowground biomass sampling. Coordinates provided in clip lists correspond to the SW corners of clip strips.  |
| sampling area     | Two 0.5m x 0.5m areas that support plant belowground biomass sampling that exist to the north and the south of the clip strip within a given clip cell.   |
| sampling cell     | A 3.0m x 0.5m rectangular area within a plot that supports plant below-ground biomass sampling and herbaceous biomass sampling. The long-edge of the cell is always oriented north/south.   |
| organic material  | For the purposes of this protocol, particulate soil organic matter made up of decayed plant parts of unrecognizable origin – i.e., it is not possible to discern leaf, twig, needle, root origin, etc.  |
| residual fraction | The mixture of organic material and root fragments < 1 cm length that is left in the bottom of the 250 µm sieve after root fragments ≥ 1 cm length have been picked out of the sample. For a subset of soil samples, root fragments in the residual fraction are quantified via the dilution technique. |

## 3 METHOD

The Standard Operating Procedures (SOPs) presented in this protocol describe tasks that, when taken together, allow estimation of plant belowground fine root biomass across four diameter size classes. These SOPs are:

- **SOP A: Preparing for Sampling.** Instructions to prepare for sampling for SOP A, SOP B, and O.
- **SOP A:**

|  |                         |                        |
|--|-------------------------|------------------------|
| <i>Title:</i> TOS Protocol and Procedure: Plant Belowground Biomass Sampling |                         | <i>Date:</i> 01/22/219 |
| <i>NEON Doc. #:</i> NEON.DOC.014038  | <i>Author:</i> C. Meier | <i>Revision:</i> G     |

- **Plant Belowground Biomass Soil Sampling in the Field.** Collecting soil samples from peak herbaceous biomass clip harvest “cells” in the field, and recording required data and metadata.
- **SOP B:**

|  |                         |                        |
|--|-------------------------|------------------------|
| <i>Title:</i> TOS Protocol and Procedure: Plant Belowground Biomass Sampling |                         | <i>Date:</i> 01/22/219 |
| <i>NEON Doc. #:</i> NEON.DOC.014038  | <i>Author:</i> C. Meier | <i>Revision:</i> G     |

- **Processing Belowground Biomass Samples in the Laboratory.** Steps to wash, sieve, and separate roots  $\geq 1$  cm length from mineral soil and organic matter. This SOP also describes steps to dry, weigh, grind, and sub-sample roots for chemical analysis and archive.
- **0:**

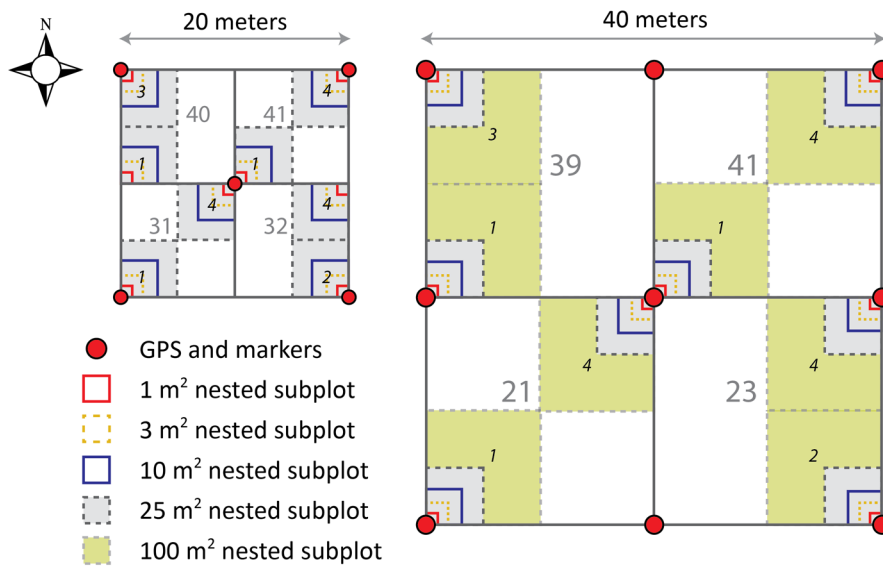


|   |                  |                 |
|---|------------------|-----------------|
| Title: TOS Protocol and Procedure: Plant Belowground Biomass Sampling |                  | Date: 01/22/219 |
| NEON Doc. #: NEON.DOC.014038  | Author: C. Meier | Revision: G     |

- Dilution Sampling for Fine Root Fragments.** A sub-sampling procedure to quantify the amount of fine root biomass present in small root fragments < 1 cm length. By carrying out this SOP, it is possible to ignore root fragments < 1 cm length in SOP B while still generating accurate fine root biomass estimates, resulting in significant time savings.

Plant belowground biomass sampling takes place in 400 m<sup>2</sup> sampling units located within Tower plots or subplots (**Figure 1**). Soil sampling does not occur in Distributed or Gradient plots. In 20m x 20m Tower plots, two soil samples are collected from one clip “cell” per bout. In larger 40m x 40m Tower plots (i.e. four 400 m<sup>2</sup> subplots per plot), soil sampling occurs in each of the two subplots randomly assigned by Science Operations for sampling, and two soil samples are collected from one clip cell per subplot per bout. This strategy means that:

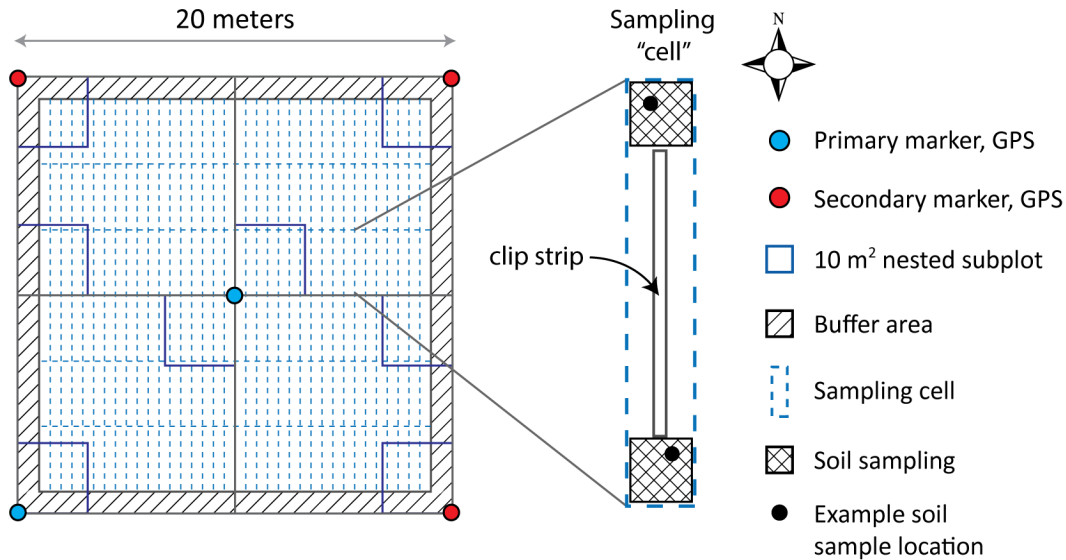
- At sites with thirty 20m x 20m Tower plots, there will be a maximum of n=60 soil samples (2 per plot).
- At sites with twenty 40m x 40m Tower plots, there will be a maximum of n=80 soil samples (4 per plot).
- For both plot types, fewer soil samples may be collected if root sampling is not possible in some plots/cells (e.g., due to large roots, rocks, etc.).



**Figure 1.** Illustration of two NEON plot sizes used for plant belowground biomass soil sampling. Grey numbers indicate subplotIDs; soil sampling is only dependent on subplots for 40m x 40m plots. Italic black numbers show the location of nested subplots that are used for % cover and diversity measurements. Soil sampling is prohibited within nested subplots ≤ 10 m<sup>2</sup>.

Within each 400 m<sup>2</sup> plot or subplot, sampling cells are 3.0m x 0.5m, and are sequentially numbered (see Appendix G). Coordinates are assigned to the SW corner of a 2.0m x 0.1m clip strip that is centered within each sampling cell. These coordinates are relative to the SW corner of the plot or subplot – i.e.,

the SW corner of the plot or subplot is defined as having coordinates [0,0] (**Figure 2, left**). To determine soil sampling locations, consult a plot-specific “Clip List” to determine which sampling cell was (or will be) used for the peak biomass clip-harvest in the current growing season. Within each sampling cell two soil samples are ideally collected: one from each of the areas to the North AND South of the 2.0m x 0.1m clip strip (**Figure 2, right**). To avoid roots and rocks, sampling may occur anywhere within the North and South sampling areas shown in **Figure 2**.



**Figure 2.** A 20m x 20m Tower Plot showing the locations of 3.0m x 0.5m sampling cells used for plant belowground biomass soil sampling (*left*); sampling cells that overlap 10 m<sup>2</sup> and smaller nested subplots are not sampled and the largest 25 m<sup>2</sup> nested subplot has been omitted for clarity. Within a cell selected for soil sampling, one soil sample is collected from each of the 0.5m x 0.5m areas to the North and South of the clip-strip (*right*).

Prior to collecting a soil sample, crowns, corms, rhizomes, and other perennial belowground parts that are not roots are removed from the top 3 cm of soil and discarded (this may also be done in the laboratory prior to sample processing). In some ecosystems, these non-root belowground plant parts may constitute a significant portion of the belowground biomass; however, the NEON protocol is solely focused on measuring fine root biomass.

After sampling from a given cell is completed, site hosts may require that holes be backfilled with an approved material (e.g. purchased sand, soil from another site-host approved location, etc.).

Standard Operating Procedures (SOPs), in Section 7 of this document, provide detailed step-by-step directions, contingency plans, sampling tips, and best practices for implementing this sampling procedure. To properly collect and process samples, field staff **must** follow the protocol and associated SOPs. Use NEON’s incident reporting system to resolve any field issues associated with implementing this protocol.

|   |                  |                 |
|---|------------------|-----------------|
| Title: TOS Protocol and Procedure: Plant Belowground Biomass Sampling |                  | Date: 01/22/219 |
| NEON Doc. #: NEON.DOC.014038  | Author: C. Meier | Revision: G     |

The value of NEON data hinges on consistent implementation of this protocol across all NEON domains, for the life of the project. It is therefore essential that field personnel carry out this protocol as outlined in this document. In the event that local conditions create uncertainty about carrying out these steps, it is critical that technicians document the problem and enter it in NEON’s incident reporting system.

Quality assurance is performed on data collected via these procedures according to the NEON Science Performance QA/QC Plan (AD[06]).

### 3.1 Integrating Plant Belowground Biomass and Herbaceous Biomass Sampling

- In Tower Plots, the Plant Belowground Biomass Sampling protocol and the Herbaceous Biomass protocol (RD[11]) are spatially collocated, and should occur in the same cell in a given sampling year (**Figure 2, right**).
- In an ‘on’ year for plant Belowground Biomass Sampling, the Clip List should indicate whether the Herbaceous Biomass protocol was performed prior to soil sampling. Always attempt to acquire soil samples from the same cell used for clip harvesting.
- When accepting/rejecting cells for potential sampling, be sure to consider suitability and representativeness with respect to **both** protocols.

|   |                  |                 |
|---|------------------|-----------------|
| Title: TOS Protocol and Procedure: Plant Belowground Biomass Sampling |                  | Date: 01/22/219 |
| NEON Doc. #: NEON.DOC.014038  | Author: C. Meier | Revision: G     |

## 4 SAMPLING SCHEDULE

### 4.1 Sampling Frequency and Scheduling

#### **Sampling Frequency:**

Plant Belowground Biomass soil samples are collected according to the schedule in **Table 2**, and implementation of this protocol is scheduled on an inter-annual basis at a given site as part of a suite of synchronized TOS measurements aimed at characterizing plant and soil biogeochemical dynamics.

Synchronized protocols and SOPs include:

- TOS Protocol and Procedure: Soil Biogeochemical and Microbial Sampling, including the N-transformations SOP (RD[07])
- TOS Protocol and Procedure: Litterfall and Fine Woody Debris, litter chemistry component (RD[13])
- TOS Protocol and Procedure: Canopy Foliage Chemistry and Leaf Mass per Area Measurements (RD[14])

**Table 2.** Sampling frequency for plant belowground biomass sampling procedures on a per SOP per plot type basis.

| SOP   | Plot Type   | Plot Number | Sampling Events      | Yearly Interval | Remarks   |
|-------|-------------|-------------|----------------------|-----------------|---|
| SOP A | Tower       | All         | 1X per sampling year | 5 y             | Sampling year is synchronized with protocols listed above.                    |
|       | Distributed | NA          | NA                   | NA              | Distributed and Gradient plots are not sampled for plant belowground biomass. |
| SOP B | Tower       | All         | 1X per sampling year | Same as SOP A   | SOP quantifies roots $\geq 1$ cm length                                       |
| 0     | Tower       | All         | 1X per sampling year | Same as SOP A   | Dilution sampling quantifies mass of root fragments $< 1$ cm length.          |

#### **Scheduling Considerations:**

- **Coordinating with Plant Diversity Sampling:** Plant Belowground Biomass Sampling takes place in all Tower Plots and is collocated with Plant Diversity at the plot scale in a subset of 3 randomly selected Tower Plots.
  - If Plant Diversity sampling is scheduled to occur prior to plant Belowground Biomass Sampling in a given year, it may be helpful to identify and demarcate a suitable sampling cell prior to performing Plant Diversity sampling. This will ensure that the cell is not trampled during diversity sampling.

|   |                  |                 |
|---|------------------|-----------------|
| Title: TOS Protocol and Procedure: Plant Belowground Biomass Sampling |                  | Date: 01/22/219 |
| NEON Doc. #: NEON.DOC.014038  | Author: C. Meier | Revision: G     |

- Should plant Belowground Biomass Sampling occur before Plant Diversity sampling, take care to avoid trampling 1 m<sup>2</sup> nested subplots used for Plant Diversity % cover measurements.
- **Bout Completion:** A given sampling bout should ideally be concluded within **6 weeks** of initiation so that the belowground standing crop does not change appreciably during the time that all target plots are sampled.
  - This ensures that data collected across all plots within a given sampling bout are as comparable as possible.
- **Field Work and Laboratory Processing:** After soil samples are collected from a given sampling cell, the following points are critical with respect to timing:
  - Keep soil samples cold until they are processed in the laboratory. This is because root biomass is biologically active after sampling, and fine root structures are delicate and decompose easily. Samples may be kept cold by:
    - Keeping soil samples in a cooler, kept cold with re-usable cold packs. Cold packs should be exchanged for fresh cold packs every 12 hours. Or,
    - Placing soil samples in a 4–8 °C refrigerator.
  - Process collected soil samples in the laboratory as soon as possible.
    - Ideally, soil samples are processed in the laboratory **within 24 h** of collection.
    - It is acceptable to keep soil samples in cold storage for up to a **maximum of 72 h**.
    - Once laboratory processing is initiated on a given sample, it is acceptable to pause overnight between sieving and sorting provided that:
      - The sample is refrigerated overnight.
      - No longer than 72 h elapses between field collection and beginning sorting.
      - See SOP C.1.1 for details.
  - **Scheduling sieving (SOP B) and Dilution Sampling (0):** It is acceptable to pause overnight between execution of SOP B and 0.

|   |                  |                 |
|---|------------------|-----------------|
| Title: TOS Protocol and Procedure: Plant Belowground Biomass Sampling |                  | Date: 01/22/219 |
| NEON Doc. #: NEON.DOC.014038  | Author: C. Meier | Revision: G     |

## 4.2 Criteria for Determining Onset of Sampling

It is desirable to perform belowground biomass core sampling when the root crop is at peak biomass. However, peak belowground biomass does not necessarily correspond with peak aboveground biomass, and in some ecosystems, does not vary in a predictable manner within a growing season from year to year (Milchunas and Lauenroth 2001). Combined with the fact that belowground biomass timecourse data are unavailable for the majority of NEON sites, the timing of belowground biomass soil core sampling is guided by these two factors, listed in order of importance:

- **Date of peak biomass herbaceous clip harvest:** Perform belowground biomass soil coring either immediately before, during, or immediately after the herbaceous clip harvest associated with the greatest aboveground *peak biomass*.
  - Site-specific sampling start guidance for Herbaceous Biomass Clip Harvest is derived from the MODIS-EVI satellite product, and is provided in Appendix D of RD[11].
- **Soil moisture:**
  - **Soil hardness:** At some sites, peak herbaceous biomass occurs during hot, dry parts of the year when soils are extremely hard and virtually impenetrable due to high clay content (e.g. D10 CPER). At sites where these conditions occur, the timing of soil core sampling may be moved to earlier in the growing season when soil moisture is more conducive to soil sampling.
    - If soil hardness dictates the timing of sampling, it is not important exactly when in the growing season sampling occurs, but once an acceptable sampling window is chosen for a given site, all future sampling within that site should be initiated within  $\pm 2$  weeks of that sampling window.
    - Notify Science staff of the selected sampling start date so that this protocol document may be updated to reflect site-specific sampling dates used for future planning.
  - **Standing water:** At sites where plots may be seasonally submerged (e.g. D03 DSNY), soil sampling is ideally scheduled to avoid standing water in potential sampling locations.
    - If a plot is partially submerged but still accessible for terrestrial sampling, “cells” that contain standing water must be rejected for soil sampling, and a new clip-location “cell” must be chosen.
    - If plots are fully submerged and the schedule cannot be adjusted to avoid flooding, assess plots for sampling according to SOP B.3.

|   |                  |                 |
|---|------------------|-----------------|
| Title: TOS Protocol and Procedure: Plant Belowground Biomass Sampling |                  | Date: 01/22/219 |
| NEON Doc. #: NEON.DOC.014038  | Author: C. Meier | Revision: G     |

### 4.3 Sampling Timing Contingencies

**Table 3.** Contingency decisions for plant belowground biomass sampling.

| Delay/<br>Situation | Action  | Outcome for Data Products  |
|---------------------|---|--|
| Hours               | If delay prevents collecting the second sample from a given cell:<br>1. Bag and label first sample,<br>2. Place labeled bags into a cooler.<br>3. Resume soil sampling in same cell ASAP  | None   |
|                     | If delay occurs between plots or subplots: Resume sampling ASAP.  |  |
| 1-14 days           | If delay prevents collecting the second sample from a given cell:<br>1. Bag and label first sample,<br>2. Place labeled bags into a cooler.<br>3. Process first sample within 72 hours of collection,<br>4. Resume collection of second sample in same cell ASAP. | Increased uncertainty in belowground biomass estimates.  |
|                     | If delay occurs between plots or subplots:<br>1. Process collected samples within 72 hours.<br>2. Resume soil sampling at additional required plots ASAP.   |  |
| 14+ days            | If delay prevents collecting the second sample from a given cell:<br>1. Bag and label first sample,<br>2. Place labeled bags into a cooler.<br>3. Process first sample within 72 hours of collection,<br>4. Resume collection of second sample in same cell ASAP. | Potentially substantial increases in uncertainty for belowground biomass estimates.<br><br>If delay prevents completing sampling from all plots or subplots within a 6 week window, belowground biomass may fluctuate substantially. |
|                     | If delay occurs between plots or subplots:<br>1. Process collected samples within 72 hours.<br>2. Resume soil sampling at additional required plots ASAP.   |  |

### 4.4 Criteria for Reallocation of Sampling Within a Site

Plant Belowground Biomass sampling occurs on the schedule described above at up to 30 Tower Plots per site. Ideally, sampling occurs at these sampling locations for the lifetime of the Observatory (core sites) or the duration of the site’s affiliation with the NEON project (relocatable sites). However, circumstances may arise that require that sampling within a site be shifted from one particular location to another. In general, sampling is considered to be compromised when sampling at a location becomes

|   |                  |                 |
|---|------------------|-----------------|
| Title: TOS Protocol and Procedure: Plant Belowground Biomass Sampling |                  | Date: 01/22/219 |
| NEON Doc. #: NEON.DOC.014038  | Author: C. Meier | Revision: G     |

so limited that data quality is significantly reduced. If sampling at a given plot becomes compromised, a problem ticket should be submitted by Field Operations to Science.

There are two main pathways by which sampling can be compromised. Sampling locations can become inappropriately suited to answer meaningful biological questions (e.g., a terrestrial sampling plot becomes permanently flooded). Alternatively, sampling locations may be located in areas that are logistically impossible to sample on a schedule that that is biologically meaningful.

For Plant Belowground Biomass sampling, criteria for considering a plot compromised include:

- If sampling cannot be completed in a plot for 2 consecutive bouts. Because bouts are scheduled every 5 y, it is necessary to examine the **Root Sampling Possible** field from previous bouts to determine whether a sampling location has become compromised.

## 5 SAFETY

This document identifies procedure-specific safety hazards and associated safety requirements. It does not describe general safety practices or site-specific safety practices.

Personnel working at a NEON site must be compliant with safe field work practices as outlined in the EHSS Policy, Program and Management Plan (AD[01]), and the Operations Field Safety and Security Manual (AD[02]). Additional safety issues associated with this field procedure are outlined below. The Field Operations Manager and the Lead Field Technician have primary authority to stop work activities based on unsafe field conditions; however, all employees have the responsibility and right to stop their work in unsafe conditions.

**For the field procedures**, safety training is required to properly use the soil corer (e.g., use of heavy gloves and hearing protection). Soils may contain fungi that may cause illness. Refer to the Operations Field Safety and Security Plan (AD[02]) for details on locations and appropriate precautions. In addition, a laser rangefinder/hypsometer/compass instrument may be used to navigate to cells within plots. Safety considerations for this instrument include:

- Avoid staring directly at the laser beam for prolonged periods. The rangefinder is classified as eye-safe to Class 1 limits, which means that virtually no hazard is associated with directly viewing the laser output under normal conditions. As with any laser device, however, reasonable precautions should be taken in its operation. It is recommended that you avoid staring into the transmit aperture while firing the laser.
- Never attempt to view the sun through the scope. Looking at the sun through the scope may permanently damage the eyes.

**For the laboratory procedures**, safety training is required before operating the grinding mill.



|   |                  |                 |
|---|------------------|-----------------|
| Title: TOS Protocol and Procedure: Plant Belowground Biomass Sampling |                  | Date: 01/22/219 |
| NEON Doc. #: NEON.DOC.014038  | Author: C. Meier | Revision: G     |

**For samples that may contain tissue from *Toxicodendron spp.*:** Additional safety issues associated with this field procedure include potential exposure to oils from roots of *Toxicodendron spp.* (discussed in Appendix F, AD[02] and RD[12]).



- Throughout this document, the warning pictogram at left is used to identify steps relevant to collecting or processing samples that may contain *Toxicodendron* root tissue.

|   |                  |                 |
|---|------------------|-----------------|
| Title: TOS Protocol and Procedure: Plant Belowground Biomass Sampling |                  | Date: 01/22/219 |
| NEON Doc. #: NEON.DOC.014038  | Author: C. Meier | Revision: G     |

## 6 PERSONNEL AND EQUIPMENT

### 6.1 Equipment

The following equipment is needed to implement the procedures in this document. Equipment lists are organized by task. They do not include standard field and laboratory supplies such as charging stations, first aid kits, drying ovens, refrigerators, etc.

**Table 4.** SOP A equipment list – Sampling plant belowground biomass in the field.

| Supplier             | Supplier Number | R/S | Description   | Purpose   | Conditions Used                    | Quantity | Special Handling |
|----------------------|-----------------|-----|---|---|------------------------------------|----------|------------------|
| <b>Durable Items</b> |                 |     |   |   |                                    |          |                  |
|                      |                 | R   | Mobile data collection device, tablet or equivalent | Record field sampling metadata                            | All                                | Variable | N                |
| Giddings Machine Co. | ST092R          | R   | Soil core sampling tube, 36" length, 3" OD          | Collect soil core sample                                  | All                                | 1        | N                |
| Giddings Machine Co. | HS114           | R   | Soil core drive head assembly                       | Works with slide hammer to drive soil core tube into soil | All                                | 1        | N                |
| Giddings Machine Co. | HS264           | R   | Soil core drive head pin, 3" length                 | Attach drive head assembly to core tube                   | All                                | 2        | N                |
| Giddings Machine Co. | ST236           | R   | Soil core quick relief bit, 3" OD*                  | Attach to soil core sampling tube                         | Standard bit for coring most soils | 1        | N                |

|   |                  |                 |
|---|------------------|-----------------|
| Title: TOS Protocol and Procedure: Plant Belowground Biomass Sampling |                  | Date: 01/22/219 |
| NEON Doc. #: NEON.DOC.014038  | Author: C. Meier | Revision: G     |

| Supplier             | Supplier Number | R/S | Description  | Purpose   | Conditions Used                       | Quantity | Special Handling |
|----------------------|-----------------|-----|--|---|---------------------------------------|----------|------------------|
| Giddings Machine Co. | HS304           | R   | Soil core slide hammer, 16#                                  | Drive sampling tube into soil                                   | All                                   | 1        | N                |
| Giddings Machine Co. | ST606           | R   | Soil core basket retainer, 3" adapter                        | Attach basket retainer system to sampling tube                  | Sandy soils that do not hold together | 1        | N                |
| Giddings Machine Co. | ST636           | R   | Soil core basket retainer, 3" basket                         | Retain sandy soil in sampling tube                              | Sandy soils that do not hold together | 2        | N                |
| Giddings Machine Co. | ST666           | R   | Soil core basket retainer, 3" bit                            | Bit that works with basket retainer                             | Sandy soils that do not hold together | 1        | N                |
|                      |                 | S   | Toothbrush   | Clean soil corer threads in field, if changing bit is required. | Field                                 | 2        | N                |
| Target               |                 | S   | Long-handled brush   | Clean soil core tube between samples.                           | Soils that stick to core tube         | 1        | N                |
| Amazon Cabela's REI  | IK270217 895022 | S   | GPS unit, pre-loaded with plot locations                     | Navigate to plots or subplots                                   | All                                   | 1        | N                |
| Forestry Suppliers   | 91567           | R   | TruPulse 360R laser rangefinder, current declination entered | Locate clip strip within a plot or subplot                      | Slope >20%, brushy                    | 1        | N                |

|   |                  |                 |
|---|------------------|-----------------|
| Title: TOS Protocol and Procedure: Plant Belowground Biomass Sampling |                  | Date: 01/22/219 |
| NEON Doc. #: NEON.DOC.014038  | Author: C. Meier | Revision: G     |

| Supplier                              | Supplier Number | R/S | Description   | Purpose  | Conditions Used                      | Quantity | Special Handling |
|---------------------------------------|-----------------|-----|---|--|--------------------------------------|----------|------------------|
| CompassTools<br>Forestry<br>Suppliers | 703512<br>90998 | R   | Foliage filter for laser rangefinder  | Facilitates use of TruPulse in brushy conditions   | Brushy vegetation                    | 2        | N                |
|                                       |                 | R   | Reflective surface (bicycle reflector or reflective tape on back of field notebook/clipboard) | Accurate location of clip strip with TruPulse in "FLT" mode  | Used with TruPulse                   | 1        | N                |
|                                       |                 | S   | Extra battery for TruPulse (CR123A type)  | Battery backup   | Used with TruPulse                   | 2        | N                |
|                                       |                 | R   | Fiberglass meter tape (30m or longer)   | Locate clip strip within plots or subplots   | Plot slope <20%; grassland, savannah | 1        | N                |
|                                       |                 | R   | Hand clippers, fine tip   | Remove aboveground plant parts from soil coring location   | All                                  | 1        | N                |
| Ben Meadows<br>Forestry<br>Suppliers  | 139303<br>33487 | R   | Soil knife, hori-hori style   | Loosen soil at surface to expose non-root plant parts, and collect monolith sample (when applicable) | All                                  | 1        | N                |

|   |                  |                 |
|---|------------------|-----------------|
| Title: TOS Protocol and Procedure: Plant Belowground Biomass Sampling |                  | Date: 01/22/219 |
| NEON Doc. #: NEON.DOC.014038  | Author: C. Meier | Revision: G     |

| Supplier                | Supplier Number | R/S | Description   | Purpose   | Conditions Used                      | Quantity      | Special Handling |
|-------------------------|-----------------|-----|---|---|--------------------------------------|---------------|------------------|
|                         |                 | R   | Large chest-style cooler, with frozen cold packs  | Keep core samples cool, slow down root decomposition; one cooler per 8 cores sampled. | All                                  | 2+            | N                |
|                         |                 | R   | Sharpies  | Label paper bags  | All                                  | 2             | N                |
| Ben Meadows             | 100952          | R   | Chaining pins, steel  | Stretching tapes to enable location of target clip strip                              | Plot slope <20%; grassland, savannah | 2             | N                |
|                         |                 | R   | Measuring device, with 1 cm demarcations (e.g., tape, ruler, collapsible measuring stick, etc.) | Measure depth of the litter layer and depth of soil core bore hole                    | All                                  | 1             | N                |
|                         |                 | S   | Length of dowel, 1" PVC or equivalent (36" total length)  | Push soil core sample out of soil core sampling tube                                  | Soil core sticks to tube             | 1             | N                |
|                         |                 | S   | Heavy duty work gloves  | Protect hands during soil core sampling   | All                                  | 1 pair/person | N                |
|                         |                 | S   | Rubber mallet   | Drive soil knife into soil to collect sample.   | Monolith sampling                    | 1             | N                |
| <b>Consumable items</b> |                 |     |   |   |                                      |               |                  |

|   |                  |                 |
|---|------------------|-----------------|
| Title: TOS Protocol and Procedure: Plant Belowground Biomass Sampling |                  | Date: 01/22/219 |
| NEON Doc. #: NEON.DOC.014038  | Author: C. Meier | Revision: G     |

| Supplier | Supplier Number | R/S | Description                                      | Purpose  | Conditions Used   | Quantity   | Special Handling |
|----------|-----------------|-----|--|--|---|------------|------------------|
|          |                 | R   | 4"x 5" pin flags with PVC stakes                 | Accurate location of clip strip; PVC stakes avoid magnetic interference with compass or TruPulse | All   | 6          | N                |
|          |                 | R   | Heavy duty freezer bags, 1.5 or 2 gallon         | Store and organize soil core samples   | All   | 40+        | N                |
|          |                 | S   | Hearing protection                               | Prevent hearing damage from use of slide hammer.   | All   | As needed  | N                |
|          |                 | R   | Pencils  | Record sampling metadata   | All   | 2          | N                |
|          |                 | R   | Waterproof paper, Rite-in-the-Rain or equivalent | Material for making labels to record soil core metadata in the field                             | All   | 10+ sheets | N                |
| Avery    | 94200           | S   | Weatherproof film address labels, 1" x 2 5/8"    | Moveable label to track sample from field through lab processing.                                | When label can stick to bags, sieves, without detaching | 25 sheets  | N                |
|          |                 | R   | Clip Lists                                       | Identify clip cell associated with peak biomass clip harvest                                     | All   | Varies     | N                |

|   |                  |                 |
|---|------------------|-----------------|
| Title: TOS Protocol and Procedure: Plant Belowground Biomass Sampling |                  | Date: 01/22/219 |
| NEON Doc. #: NEON.DOC.014038  | Author: C. Meier | Revision: G     |

| Supplier | Supplier Number | R/S | Description                                   | Purpose  | Conditions Used                             | Quantity         | Special Handling |
|----------|-----------------|-----|---|--|---|------------------|------------------|
|          |                 | R   | Random Tower Subplot Lists                    | Identify subplots for soil core sampling   | Tower plots $\geq 1600$ m <sup>2</sup>      | Varies           | N                |
| RD[05]   |                 | R   | Belowground biomass “Field Coring Datasheets” | Record sampling metadata   | All   | Varies           | N                |
|          |                 | S   | Horticultural grade sand                      | Backfill core holes at sites where specified by site host                                | As specified                                | 4-5 lbs per core | N                |
|          |                 | S   | Adhesive barcode labels (Type I)              | Label samples with barcode readable labels   | All   | 1 sheet          | N                |
| ULINE    | S-21339         | R   | Sample warning pictogram label                | Identify possible presence of acute toxins that may cause serious eye or skin irritation | Sample may contain <i>Toxicodendron spp</i> | 1 per sample     | N                |

R/S=Required/Suggested \* Bits with greater relief may be required to prevent soils with high clay content that are prone to expansion from getting stuck in the soil core tube. See <http://www.soilsample.com/tooling/soiltubes.htm> for available bits and soil core accessories.

|   |                  |                 |
|---|------------------|-----------------|
| Title: TOS Protocol and Procedure: Plant Belowground Biomass Sampling |                  | Date: 01/22/219 |
| NEON Doc. #: NEON.DOC.014038  | Author: C. Meier | Revision: G     |

**Table 5.** SOP B equipment list – Sieving belowground biomass cores, separating roots from soil organic matter, drying root samples, and processing root samples for shipment. Equipment listed is for 3 people working independently at a root washing station.

| Supplier             | Supplier Number          | R/S | Description   | Purpose  | Conditions Used    | Quantity | Special Handling |
|----------------------|--------------------------|-----|---|--|--------------------|----------|------------------|
| <b>Durable Items</b> |                          |     |   |  |                    |          |                  |
|                      | MX108866                 | R   | Root washing station                                      | Remove mineral soil from organic material  | All                | 1        | N                |
|                      |                          | S   | Plastic bucket, bin, or equivalent (5 gallon, 20 L, etc.) | Soak core sample prior to sieving to break up cohesive clays and rehydrate roots | All                | 6        | N                |
| Fisher               | 04-881-10G<br>04-884-1AE | R   | Soil sieve, 2 mm stainless mesh, 8” or 12” diameter       | Remove mineral soil from organic material  | All                | 6        | N                |
| Fisher               | 04-881-10L<br>04-884-1AJ | S   | Soil sieve, 1 mm stainless mesh, 8” or 12” diameter       | Remove mineral soil from organic material  | Sandy soil sieving | 6        | N                |
| Fisher               | 04-881-10U<br>04-884-1AS | R   | Soil sieve, 250 µm stainless mesh, 8” or 12” diameter     | Remove mineral soil from organic material  | All                | 6        | N                |
|                      |                          | S   | Rubber or silicone spatula                                | Transfer soil and roots from bucket to sieve(s).                                 | All                | 3        | N                |



|   |                  |                 |
|---|------------------|-----------------|
| Title: TOS Protocol and Procedure: Plant Belowground Biomass Sampling |                  | Date: 01/22/219 |
| NEON Doc. #: NEON.DOC.014038  | Author: C. Meier | Revision: G     |

| Supplier          | Supplier Number | R/S | Description   | Purpose  | Conditions Used               | Quantity | Special Handling |
|-------------------|-----------------|-----|---|--|-------------------------------|----------|------------------|
|                   |                 | R   | Rectangular plastic bin, enamel pan or equivalent, with lid; clear or white (app. 30 cm x 20 cm, or 13"x 9")† | Facilitates separating roots (which float) from mineral particles; allows secure storage in refrigerator | All                           | 6+       | N                |
|                   |                 | R   | Forceps, blunt tip, stainless steel (e.g., Bioquip 4731, 4732, 4734, 4735)                                    | Separate roots from organic material, sort root fragments from OM for dilution sampling                  | All                           | 3        | N                |
|                   |                 | R   | * Wire gauge with openings approx. 2mm, 1mm, and 0.5mm  | Sort roots into size classes during sieving and picking  | All                           | 3-10     | N                |
|                   |                 | S   | Small wire clippers   | Clip and separate smaller diameter roots that emerge or fork from bigger roots                           | Multiple sizeCategories exist | 2        | N                |
| Thomas Scientific | 1711H10         | R   | Grinding mill, Wiley, 20 mesh   | Grind larger fine root sample volumes  | Sample masses > 750 mg        | 1        | N                |

|   |                  |                 |
|---|------------------|-----------------|
| Title: TOS Protocol and Procedure: Plant Belowground Biomass Sampling |                  | Date: 01/22/219 |
| NEON Doc. #: NEON.DOC.014038  | Author: C. Meier | Revision: G     |

| Supplier                | Supplier Number | R/S | Description                                    | Purpose   | Conditions Used        | Quantity | Special Handling |
|-------------------------|-----------------|-----|--|---|------------------------|----------|------------------|
|                         |                 | S   | Porcelain mortar, 65 mL capacity, with pestle, | Grind smaller fine root sample volumes, avoid loss of small samples in mill | Sample masses < 750 mg | 1 set    | N                |
| Fisher                  | NC9052925       | R   | Sample microsplitter                           | Creates identical sub-samples from ground sample                            | Large root volumes     | 1        | N                |
| Fisher                  | NC0516918       | R   | Hi-back pans for sample microsplitter          | 2 per splitter; receives split sub-sample                                   | With micro splitter    | 2        | N                |
|                         |                 | R   | Sharpie, extra fine tip                        | Labeling envelopes and scint vials  | All                    | 2        | N                |
|                         |                 | R   | Balance, 0.001 g accuracy or better            | Weigh very light root samples   | All                    | 1        | N                |
|                         |                 | R   | Desiccator                                     | Keep oven-dried samples moisture free before weighing                       | All                    | 1        | N                |
| <b>Consumable items</b> |                 |     |  |   |                        |          |                  |
|                         |                 | R   | Pencils  | Record dry weight of root samples   | All                    | 2        | N                |
| RD[05]                  |                 | R   | Lab Weighing Datasheet                         | Record dry weight of root samples   | All                    | Variable | N                |

|   |                  |                 |
|---|------------------|-----------------|
| Title: TOS Protocol and Procedure: Plant Belowground Biomass Sampling |                  | Date: 01/22/219 |
| NEON Doc. #: NEON.DOC.014038  | Author: C. Meier | Revision: G     |

| Supplier | Supplier Number   | R/S | Description  | Purpose   | Conditions Used       | Quantity              | Special Handling |
|----------|---|-----|--|---|-----------------------|-----------------------|------------------|
|          |   | R   | Scintillation vials with caps, 20 mL volume (glass vials may be best if static is problematic) | Containers for ground split sub-samples                 | All                   | Up to four per sample | N                |
|          |   | R   | Large weigh boats or aluminum weigh pans (metal may be best if static is problematic)          | Weigh relatively large quantities of dried root samples | Large root quantities | 50+                   | N                |
|          |   | R   | Clasp envelopes, 6"x 9", Kraft paper   | Store and organize sieved roots during and after drying | Large root quantities | 480-640               | N                |
|          |   | R   | Coin envelopes, 3 3/8"x6", Kraft paper   | Store and organize sieved roots during and after drying | Small root quantities | 50                    | N                |
|          |   | R   | Paper bag, 8# Kraft  | Organize root samples in the drying ovens               | All                   | 20                    | N                |
|          | <a href="http://a.co/d/b70BBdB">http://a.co/d/b70BBdB</a> | S   | Small weigh boats or aluminum weigh pans (metal may be best if static is problematic)          | Weigh relatively small quantities of dried root samples | Small root quantities | 50+                   | N                |
|          |   | R   | Adhesive barcode labels (Type I)   | Label samples with barcode readable labels              | All                   | 1 sheet               | N                |

|   |                  |                 |
|---|------------------|-----------------|
| Title: TOS Protocol and Procedure: Plant Belowground Biomass Sampling |                  | Date: 01/22/219 |
| NEON Doc. #: NEON.DOC.014038  | Author: C. Meier | Revision: G     |

| Supplier | Supplier Number | R/S | Description                    | Purpose  | Conditions Used                             | Quantity     | Special Handling |
|----------|-----------------|-----|--------------------------------|--|---|--------------|------------------|
|          |                 | R   | Dessicant                      | Keep oven-dried samples moisture free before weighing                                    | All   | As needed    | N                |
| ULINE    | S-21339         | R   | Sample warning pictogram label | Identify possible presence of acute toxins that may cause serious eye or skin irritation | Sample may contain <i>Toxicodendron spp</i> | 1 per sample | N                |

R/S=Required/Suggested

\* Gauge 12 = 2.05 mm, gauge 18 = 1.02 mm, and gauge 24 = 0.51 mm; while not *exactly* the diameters desired, the gauges listed here are acceptable for this protocol.

† Note: the exact dimensions of the pan/tub are not critical, it serves as an aid for more easily spotting roots suspended in water. The only requirement is that it can safely contain liquid; a white material also makes identifying roots easier.

|   |                  |                 |
|---|------------------|-----------------|
| Title: TOS Protocol and Procedure: Plant Belowground Biomass Sampling |                  | Date: 01/22/219 |
| NEON Doc. #: NEON.DOC.014038  | Author: C. Meier | Revision: G     |

**Table 6. 0** equipment list – Dilution sampling for fine root biomass fragments < 1 cm

| Item No.             | Supplier Number            | R/S | Description  | Purpose  | Quantity              | Special Handling |
|----------------------|----------------------------|-----|--|--|-----------------------|------------------|
| <b>Durable Items</b> |                            |     |  |  |                       |                  |
| Fisher               | 04-881-10-DD<br>04-884-1BC | S   | Soil sieve, 53 µm stainless mesh, 8” or 12” diameter   | Consolidate residual fraction from both samples per clip strip, rinse, and transfer to beaker for dilution | 2                     | N                |
| Fisher               | S88857200<br>S07978S       | R   | Magnetic mixing plate, stir range 150-2500; or, 50-1500 rpm, minimum 4 x 4 inch stirring surface | Randomize aqueous suspended residual fraction  | 1                     | N                |
|                      |                            | R   | Magnetic stir bar, 2” to 3” length   | Randomize aqueous suspended residual fraction  | 2                     | N                |
|                      |                            | S   | Beaker, 1 L  | Hold smaller volumes of aqueous suspended residual fraction  | 2                     | N                |
|                      |                            | S   | Beaker, 2 L  | Hold large volumes of aqueous suspended residual fraction  | 2                     | N                |
|                      |                            | S   | Beaker, 4 L  | Hold very large volumes of aqueous suspended residual fraction; e.g., for soils with thick O horizon       | 2                     | N                |
|                      |                            | R   | Plunger, diameter approx. 1 cm less than beaker diameter   | Stop mixing vortex, randomize aqueous suspended residual fraction  | 1 per per beaker size | N                |

|   |                  |                 |
|---|------------------|-----------------|
| Title: TOS Protocol and Procedure: Plant Belowground Biomass Sampling |                  | Date: 01/22/219 |
| NEON Doc. #: NEON.DOC.014038  | Author: C. Meier | Revision: G     |

| Item No. | Supplier Number | R/S | Description  | Purpose   | Quantity | Special Handling |
|----------|-----------------|-----|--|---|----------|------------------|
|          |                 | R   | Syringe, 40 – 60 mL, with tip cut off to make a 1 cm diameter aperture   | Aspirate sub-sample from randomized aqueous residual fraction   | 2        | N                |
|          |                 | R   | Plastic laboratory squirt bottle, filled with DI water   | Rinse syringe following sub-sampling  | 1        | N                |
|          |                 | R   | Aluminum weighing dishes, 65 mL (e.g. Fisher #: 08-732-102)  | Hold and dry root and organic material from sub-samples.  | 200      | N                |
|          |                 | R   | Forceps, fine tip  | Pick small root fragments apart from organic material   | 10-15    | N                |
|          |                 | S   | Heavy duty sheet tray, baking or equivalent  | Transfer aqueous samples in aluminum dishes to drying ovens; hold and protect samples throughout oven drying procedure. | 1        | N                |
|          |                 | R   | Balance, 0.001 g or 0.0001 g (preferred) accuracy  | Weigh extremely light dried dilution samples  | 1        | N                |
|          |                 | R   | Threaded rod or bolt, long enough to fit beaker. 1/4 " diameter recommended  | Plunger device for dilution sampling, rod   | 1        | N                |
|          |                 | R   | Semi-rigid or rigid waterproof material (e.g., vinyl laminate wall base moulding, polycarbonate), circular cut-out, with diameter ~1cm less than beaker diameter | Plunger device for dilution sampling, plunger base  | 1        | N                |

|   |                  |                 |
|---|------------------|-----------------|
| Title: TOS Protocol and Procedure: Plant Belowground Biomass Sampling |                  | Date: 01/22/219 |
| NEON Doc. #: NEON.DOC.014038  | Author: C. Meier | Revision: G     |

| Item No.                | Supplier Number | R/S | Description  | Purpose  | Quantity  | Special Handling |
|-------------------------|-----------------|-----|--|--|-----------|------------------|
|                         |                 | S   | Wood Dowel, 12" by 3/4" diameter, optional                                     | Plunger device for dilution sampling, plunger handle   | 1         | N                |
|                         |                 | R   | Hex Nuts, 1/4" (or whatever diameter fits your threaded rod)                   | Plunger device for dilution sampling, fastening  | 4         | N                |
|                         |                 | R   | Desiccator   | Keep oven-dried samples moisture free before weighing  | 1         | N                |
| <b>Consumable Items</b> |                 |     |  |  |           |                  |
|                         |                 | R   | Distilled or filtered water (18.2 MOhm not required, lesser purity acceptable) | Suspend residual fraction for dilution method; avoid mineral build-up on weighing tins used for very light samples | As needed | N                |
|                         |                 | R   | Desiccant  | Keep oven-dried samples moisture free before weighing  | As needed | N                |

R/S=Required/Suggested

|   |                  |                 |
|---|------------------|-----------------|
| Title: TOS Protocol and Procedure: Plant Belowground Biomass Sampling |                  | Date: 01/22/219 |
| NEON Doc. #: NEON.DOC.014038  | Author: C. Meier | Revision: G     |

## 6.2 Training Requirements

All personnel must complete required safety training and protocol-specific training for safety and implementation of this protocol as required in Field Operations Job Instruction Training Plan (AD[04]).

For the field component of this protocol, staff must be trained in navigating to points in the field with a GPS and manual methods. Most critically, staff must be trained to quickly identify commonly encountered types of belowground plant parts at the sites within the region of employment (e.g. crowns, corms, rhizomes, roots, etc.).



Training for both the field and laboratory work must emphasize the importance of consistent, detailed labeling and barcoding of all samples. ***Improper or inconsistent labeling is a common and problematic error associated with this work!***

## 6.3 Specialized Skills

For the field work, a minimum of 2 field staff is required for collecting soil samples due to weight of equipment and samples. When perennial grasses are present, staff must possess a demonstrated ability to identify crown material associated with these plants.

For the laboratory work, staff are required to wash, dry, weigh, grind, and sub-sample belowground biomass samples for shipment to external analytical or archive facilities.



|   |                  |                 |
|---|------------------|-----------------|
| Title: TOS Protocol and Procedure: Plant Belowground Biomass Sampling |                  | Date: 01/22/219 |
| NEON Doc. #: NEON.DOC.014038  | Author: C. Meier | Revision: G     |

#### 6.4 Estimated Personnel Hours

The time required to implement a protocol will vary depending on a number of factors, such as personnel experience, system diversity, environmental conditions, and distance between sample plots. The timeframe provided below is an estimate based on completion of a task by a skilled two-person team (i.e., not the time it takes at the beginning of the field season). Use this estimate as framework for assessing progress. If a task is taking significantly longer than the estimated time, an incident should be reported.

**Table 7.** Estimated staff and labor hours required for implementation of Plant Belowground Biomass Sampling SOPs.

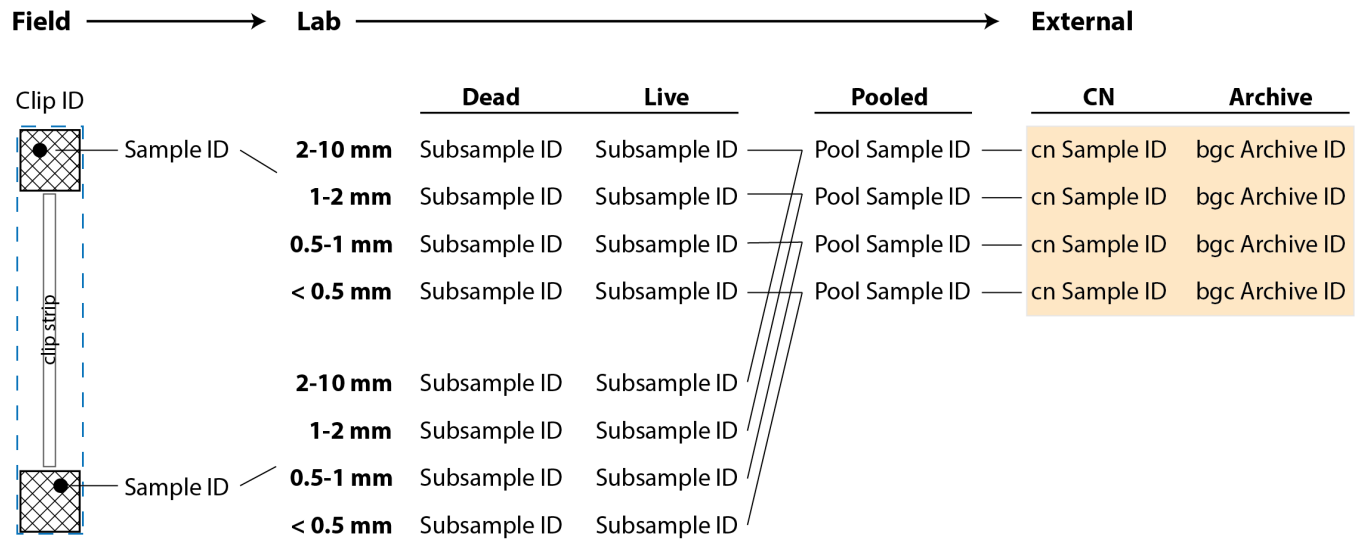
| SOP   | Estimated time                                       | Suggested staff             | Total person hours                                   |
|---|--|-----------------------------|--|
| SOP A.1: Preparing for soil core sampling in the field  | 1 h  | 1                           | 1 h  |
| SOP A.2: Preparing for processing soil cores in the lab | 0.5 h  | 1                           | 0.5 h  |
| SOP A.3: Preparing for dilution sampling                | 4-6 h (first sampling)<br>0.5 h (subsequently)       | 1                           | 4-6 h (first sampling)<br>0.5 h (subsequent)         |
| SOP B: Soil sampling in the field                       | 1 h per plot (20m x 20m)<br>2 h per plot (40m x 40m) | 2                           | 2 h per plot (20m x 20m)<br>4 h per plot (40m x 40m) |
| SOP C.1: Processing samples in the laboratory           | 1 h per core (sieving)<br>1-10 h per core (sorting)  | 1 per core                  | 2-11 h per core                                      |
| SOP C.2 and C.3: Drying, weighing and QA                | 8 h per bout (initial)<br>1 h per bout (QA weigh)    | 1 (initial)<br>1 (QA weigh) | 8 h per bout (initial)<br>1 h per bout (QA weigh)    |
| SOP C.4: Grinding for external analysis                 | 16 h per bout  | 2                           | 32 h per bout  |
| SOP D: Dilution sampling                                | 3 h per core   | 1 per core                  | 3 h per core   |
| SOP E: Data Entry and Verification                      | TBD per bout   | 2                           | TBD per bout   |
| SOP F: Sample shipment                                  | 1-2 h per bout                                       | 1                           | 1-2 h per bout                                       |

## 7 STANDARD OPERATING PROCEDURES

### SOP A Preparing for Sampling

#### A.1 Sample Labels and Identifiers

By default, each soil core or monolith collected in the field is assigned a sampleID, and roots sorted from a sample are assigned subsampleIDs. For grinding, chemical analysis, and archive, subsamples are combined to create a pooled sample that is assigned a poolSampleID, and the pooled sample is then split for chemical analysis (assigned a cnSampleID), and biogeochemistry archive (assigned a bgcArchiveID)(see **Figure 3**).



**Figure 3.** Workflow for generating unique identifiers for samples, subsamples, etc. for a clip cell from which soils are collected in the field. In the lab, live roots are pooled within a size category, ground, and split into CN and Archive samples, then shipped to external facilities. The amber box indicates samples for which barcodes are required.

- Samples, subsamples, pooled samples, and CN and Archive samples shown in **Figure 3** are labeled with location, date, and other information required to uniquely identify the sample.
- In addition to labeling samples with human readable information, samples, subsamples, etc. may also be associated with an optional scannable barcode.
  - Use of barcodes throughout this procedure greatly enhances speed and accuracy of selecting the correct sampleID throughout the data entry process.

|   |                  |                 |
|---|------------------|-----------------|
| Title: TOS Protocol and Procedure: Plant Belowground Biomass Sampling |                  | Date: 01/22/219 |
| NEON Doc. #: NEON.DOC.014038  | Author: C. Meier | Revision: G     |

### **A.1.1 Barcode Workflow**

- Barcodes are required for CN samples and Archive samples (**Figure 3**); the shipping workflow depends on barcodes.
  - Until they are linked with a subsample, barcodes do not contain information specific to sample provenance.
- Barcodes are optional at this time for other samples, subsamples and pooled samples.
  - Barcodes may improve sample tracking, and reduce transcription errors associated with writing sample and subsample identifiers by hand.
  - Barcodes may also speed entry of data into mobile applications.

If using barcodes:

- Adhesive barcode labels should be applied to dry, room temperature bags, envelopes or sample containers at least 30 minutes in advance of their use. Barcodes may also be applied at the start of the season.
- Barcodes are unique, but are not initially associated with a particular sample; if using barcodes, it is encouraged to apply these in advance.
- See Section 6.1 for the appropriate barcode label type for these procedures. Note that a barcode label is applied *in addition to* labeling the subsample with human-readable information (hand-written or printed).

Barcodes are scanned into the mobile application when indicated in the protocol; only one barcode may be associated with a particular sample, subsample, etc.. Do not reuse barcodes. If a barcode is associated with multiple subsamples, the data ingest system will throw an error and refuse to pull in entered data.

### **A.2 Preparing for plant belowground biomass sampling in the field (SOP A)**

1. Make weatherproof labels for tracking soil sampling metadata in the field:
  - a. **Option A:** Weather-proof adhesive labels
    - i. Print labels using Belowground Biomass template (**Figure 4**).
    - ii. Affix to clean plastic bags and allow adhesive to cure for approximately 24 h.
    - iii. Label templates developed by Field Science may be available via the SSL.



**Figure 4.** Label template that can be printed on weather-proof, adhesive labels and applied to field sample bags prior to field sampling (*left*). Example label illustrating information supplied in the field in red (*right*).

|   |                  |                 |
|---|------------------|-----------------|
| Title: TOS Protocol and Procedure: Plant Belowground Biomass Sampling |                  | Date: 01/22/219 |
| NEON Doc. #: NEON.DOC.014038  | Author: C. Meier | Revision: G     |

b. **Option B:** Weather-proof paper

- i. Cut weatherproof paper (Rite-in-the-Rain or equivalent) into approx. 3”x 5” rectangles.
- ii. Write metadata on the labels with Sharpie in the field, and place the labels inside the plastic bags with the soil samples.
- iii. The outside of plastic bags may also be labeled with Sharpie for easy visibility, but do **NOT** rely only on labeling the outside of bags; Sharpie can smear and become unreadable.
- iv. **Optional:** Additionally affix a Type I barcode to each rectangle, to be associated with the sampleID in the field.

2. If it is possible to collect soil cores: Use local knowledge of the soils present at the site, and determine the type of soil coring bit that is required for the soil conditions at the site (i.e. the degree of relief needed inside the bit) (**Table 8**).

**Table 8.** Soil core bits and the soil types and conditions in which they should be used.

| Bit Type                      | Intended Soil Conditions or Soil Type   |
|-------------------------------|---|
| Standard taper                | Dry soils   |
| Quick relief                  | Clay/Loam soils (i.e. “typical soils”); relief inside bit allows for moderate expansion of core inside soil core tube, prevents sample from getting stuck |
| Heavy duty quick relief       | Heavy clay soils; additional relief allows for additional expansion of core inside soil core tube   |
| Extra heavy duty quick relief | Extra heavy expansive clay soils; allows for maximal expansion of core inside soil core tube  |
| Basket retainer bit           | Works with basket retainer and basket retainer adapter to retain sandy, non-cohesive soil samples inside the soil core tube                               |

|   |                  |                 |
|---|------------------|-----------------|
| Title: TOS Protocol and Procedure: Plant Belowground Biomass Sampling |                  | Date: 01/22/219 |
| NEON Doc. #: NEON.DOC.014038  | Author: C. Meier | Revision: G     |

3. Prepare equipment and material according to **Table 9** below.

**Table 9.** Actions required to prepare equipment and materials for belowground biomass soil sampling in the field (SOP A). Equipment listed here are only those items that require preparation actions before sampling; the full equipment list is provided in **Table 4**.

| Item Description                                      | Action(s)   |
|---|---|
| Mobile data collection device                         | <ul style="list-style-type: none"> <li>Charge and sync</li> </ul>   |
| GPS unit  | <ul style="list-style-type: none"> <li>Charge</li> <li>Load target plot locations</li> </ul>  |
| Compass, mirror-sight, adjustable declination         | Check/set correct declination*  |
| TruPulse 360R laser rangefinder and clinometer        | <ul style="list-style-type: none"> <li>Check battery, charge (if possible)</li> <li>Clean lenses with lens cloth or lens tissue (if necessary)</li> <li>Check/set correct declination*. See RD[10].</li> <li>Calibrate tilt-sensor (only necessary after severe drop-shock; see RD[10]).</li> </ul> |
| 76.2mm OD (66.5mm ID) soil core tube and bit assembly | Measure 30 cm from the bottom of the bit, and mark on the tube with electrical tape.  |
| Re-usable cold packs                                  | Place in -20 °C freezer   |
| Hand clippers   | Clean and sharpen blades (if necessary)   |
| Sand, or other site-specific material                 | Check with the site host to determine the desired back-fill material. Ensure supply is sufficient for backfilling soil sampling holes.  |
| Belowground biomass “Field Sampling Datasheet”        | Print as needed on waterproof copy paper; needed for backup in the event digital data collection workflow fails.  |
| Clip Lists  | Print as needed on waterproof copy paper  |
| Tower Plot “Random Subplot List”                      | Print as needed on waterproof copy paper; only needed for 40m x 40m Tower Plots.  |

\* Declination changes with time and should be looked up annually per site: <http://www.ngdc.noaa.gov/geomag-web/>

**A.2.1 Integrating Belowground Biomass Sampling with Clip Harvest in Agricultural Plots**

1. For densely planted, tall-stature crops such as corn, delineate plant belowground biomass sampling areas and the clip strip well before crop maturity. Delineation of sampling areas will be difficult once crops are taller than breast height.

|   |                  |                 |
|---|------------------|-----------------|
| Title: TOS Protocol and Procedure: Plant Belowground Biomass Sampling |                  | Date: 01/22/219 |
| NEON Doc. #: NEON.DOC.014038  | Author: C. Meier | Revision: G     |

### A.3 Preparing for processing soil samples in the laboratory (SOP B)

1. Empty and clean root washing station sediment traps.
2. Prepare drying oven for drying root samples:
  - a. Set oven temperature to 65°C.
  - b. Clear necessary space.
3. Prepare desiccator for temporary storage of dried root samples:
  - a. Clear necessary space.
  - b. Replace/refresh desiccant as needed.
4. Prepare barcodes:
  - a. *Optional:* Affix Type I barcodes to coin envelopes used to dry roots. A minimum of one root envelope per soil sample must be barcoded to enable functionality.
  - b. **Required:** Affix Type I barcodes length-wise to 20 mL plastic scint vials. Do not wrap barcode around the vials; curved surfaces prevent accurate reading of barcodes.
5. Print lab weighing datasheets (optional, only if data are not entered directly into digital workflow).
6. Prepare scintillation vials for shipping samples that may contain *Toxicodendron spp.*:



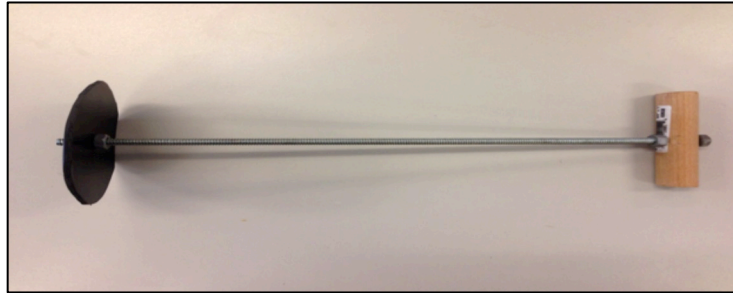
- a. Affix a *Toxicodendron* warning label to the lid of the vial, such as that shown at left.
- b. Allow label adhesive to cure for a minimum of 30 minutes at room temperature.

### A.4 Preparing for dilution sampling for fine root fragments (0)

| Item Description          | Action(s)   |
|---------------------------|---|
| Dilution Sampling Plunger | <ul style="list-style-type: none"> <li>• Assemble plunger from items listed in <b>Table 6</b>.</li> </ul> |

1. Assemble a plunger (**Figure 5**), with diameter suitable for the size of beaker selected from **Table 6**; plunger pieces can be assembled from locally available hardware store parts.
  - a. Use scissors, a utility knife, or other appropriate tool to cut a circular section out of a piece of acrylic, polycarbonate, or vinyl. The diameter of the circle should be approx. 1 cm less than the diameter of the beaker.
  - b. Create a small hole in the center of the circle just large enough to fit the threaded rod zinc rod through (hole is approx. ¼”).
  - c. Tighten on one nut <1” from the bottom. Then slide the cut disk on, and fasten with another nut.
  - d. Drill a ¼” hole completely through the wooden dowel and cut length to a preferred size.
  - e. Repeat step 3 to attach the dowel using two nuts.
  - f. Coat the nut and tip of the zinc rod at the ‘circle’ end with silicone to avoid breaking the bottom of the beaker when plunging.

|  |                         |                        |
|--|-------------------------|------------------------|
| <i>Title:</i> TOS Protocol and Procedure: Plant Belowground Biomass Sampling |                         | <i>Date:</i> 01/22/219 |
| <i>NEON Doc. #:</i> NEON.DOC.014038  | <i>Author:</i> C. Meier | <i>Revision:</i> G     |



**Figure 5.** Assembled plunger used to randomize root fragment samples < 1 cm length as part of dilution sampling (0).

2. Label aluminum weigh tins with unique Tin IDs.
3. Print lab dilution datasheets as necessary (skip if using digital workflow).

|   |                  |                 |
|---|------------------|-----------------|
| Title: TOS Protocol and Procedure: Plant Belowground Biomass Sampling |                  | Date: 01/22/219 |
| NEON Doc. #: NEON.DOC.014038  | Author: C. Meier | Revision: G     |

## SOP B Plant Belowground Biomass Soil Sampling in the Field

### Goals

- Collect two plant belowground biomass soil samples per sampling cell cell (see **Figure 2**).
- Keep soil samples cold until they are processed in the laboratory.
- Collect required field sampling metadata.
  - The preferred method for data collection is the Belowground Biomass Field mobile application.
  - The Belowground Biomass Sampling Fulcrum Manual on the SSL contains detailed data entry instructions.

### B.1 Spatially Linked Protocols

#### *Herbaceous Clip Harvest*

- If plant Belowground Biomass sampling is scheduled prior to Herbaceous Biomass clip harvest sampling, accepting/rejecting sampling cells must be done with both protocols in mind.
  - It is highly desirable for accepted sampling cells to support both protocols.
- If Herbaceous Biomass sampling is scheduled before plant Belowground Biomass sampling:
  - Consult each per plot Clip List to enable co-location of sampling within cells in each plot.
  - Stagger the sampling activities to ensure sufficient oven space for all samples.
- At Agricultural sites:
  - Tall-stature crops may require pre-delineation of sampling areas (SOP A.2).
  - Additional steps are required to ensure that soil sampling areas and agricultural clip strips do not overlap (SOP B.5).

#### *Plant Diversity*

- Plant Diversity sampling occurs in 3 randomly selected Tower Plots each year. In these plots, identify and demarcate a suitable sampling cell for plant belowground biomass/herbaceous biomass sampling prior to performing Plant Diversity sampling.
- This will ensure that the cell is not trampled during Plant Diversity sampling.



|   |                  |                 |
|---|------------------|-----------------|
| Title: TOS Protocol and Procedure: Plant Belowground Biomass Sampling |                  | Date: 01/22/219 |
| NEON Doc. #: NEON.DOC.014038  | Author: C. Meier | Revision: G     |

## B.2 Soil Sample Collection

1. Navigate to the plot or subplot to be sampled.
  - See SOP B.3 if the entire plot is flooded.
2. Use the plot or subplot-specific Clip List to identify the sampling cell that was (or will be) used for the peak herbaceous biomass clip harvest in the current year.
  - If the site host allows, a pin flag may be left behind at the SW corner of the clip strip to aid collocation across protocols.
  - The Clip List provides the randomized list of potential sampling cells per plot or subplot.
  - Coordinates provided for each cell correspond to the SW corner of the clip-strip – i.e. the area from which herbaceous biomass is harvested (**Figure 2**).
  - The Clip List indicates which cells have already been harvested or rejected; on the Clip List, mark cells selected for Plant Belowground Biomass Sampling with **status** = 5.
  - If the desired peak biomass sampling cell is submerged by standing water, but the entire plot is not submerged:
    - Reject and work down the Clip List to choose an acceptable cell, and record “peak biomass cell submerged” in the “remarks” field of the Clip List.
3. Locate the relative **offsetEasting** and **offsetNorthing** coordinates of the SW corner of the clip-strip within the target sampling “cell”. The procedure used to locate the **offsetEasting** coordinate depends on the value of the relative **offsetNorthing** coordinate:

*If the **offsetNorthing** coordinate is < 10:*

- a. Run a tape East/West along the south edge of the plot or subplot between the (0,0) → (20,0) plot markers (**Figure 2**), and stretch the tape taut.\*
- b. Place a pin flag at the desired relative X-coordinate.
- c. Standing directly over the pin flag that was just placed, use the TruPulse in **HD** mode with a reflective surface to locate the Y-coordinate.
  - Make sure the azimuth is 0° (True North) when shooting the TruPulse to find the Y-coordinate (see RD[10] for detailed instructions for operating the TruPulse).
- d. Place a pin flag at the clip-strip (X,Y) location – i.e. the SW corner of the clip-strip.

*If the **offsetNorthing** coordinate is > 10:*

- a. Run a tape\* East/West from the plot or subplot centroid (10,10) to either the (0,10) position or the (20,10) position (**Figure 2**).

| offsetEasting coordinate | Tape Layout <sup>1</sup> |
|--------------------------|--------------------------|
| 1 < X < 10               | From (10,10) → (0,10)    |
| 10 < X < 20              | From (10,10) → (20,10)   |

<sup>1</sup> Use the TruPulse in **AZ** mode to guide the tape along the correct azimuth.

|   |                  |                 |
|---|------------------|-----------------|
| Title: TOS Protocol and Procedure: Plant Belowground Biomass Sampling |                  | Date: 01/22/219 |
| NEON Doc. #: NEON.DOC.014038  | Author: C. Meier | Revision: G     |

- b. Place a pin flag at the desired relative **offsetEasting** coordinate.
- c. Standing directly over the pin flag that was just placed, use the TruPulse in **HD** mode with a reflective surface to locate the Y-coordinate.
  - Make sure the azimuth is 0° (True North) when shooting the TruPulse to find the Y-coordinate (see RD[10] for detailed instructions for operating the TruPulse).
- d. Place a pin flag at the SW corner of the Clip Strip.

## TIPS



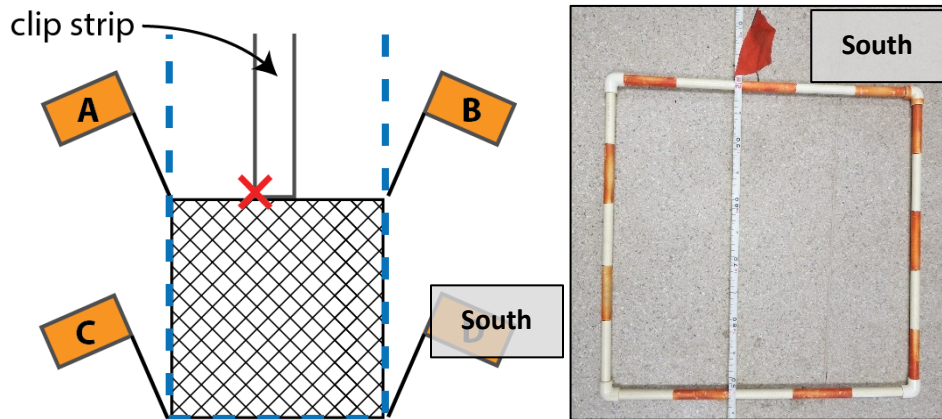
- If the plot slope is > 20%, or there is significant brush or obstacles that prevent accurately stretching a tape, the TruPulse laser rangefinder must be used in **HD** mode to place the initial pin flags relative to the plot markers.
- Plot slope can be quickly estimated using the inclinometer in the TruPulse (**INC** mode).

4. Assess whether the sampling cell is representative of the plot, and accept or reject the location.
 

**Remember that you must consider both this protocol, and the Herbaceous Biomass protocol.**

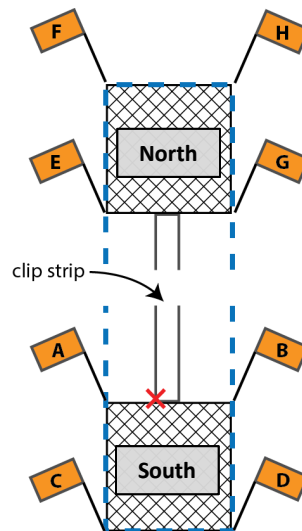
  - See Figure 3 in SOP B of RD[11] for detailed acceptance/rejection criteria.
  - Obstacles, disturbances, and/or irregularities on the surface may lead to a cell being unrepresentative, and these may include trees, large rocks, ant nests, downed logs, etc.
  - If > 3 consecutive potential cells are rejected as ‘unrepresentative,’ it is necessary to recalibrate the working definition of ‘representative.’
5. Mark the four corners of the South root sampling area within the sampling cell to delineate where the first of the two soil samples should be collected (**Figure 6**). Pin flags, a 50cm x 50cm PVC frame, or equivalent can be employed for this purpose. If using pin flags:
  - a. Place pin flag “A” 20 cm to the west of the coordinates provided in the Clip List (i.e. the red “x” in **Figure 6**) – use a meter tape or ruler to be accurate.
  - b. Place pin flag “B” 50 cm to the east of pin flag “A”
  - c. Place pin flag “C” 50 cm to the south of pin flag “A”
  - d. Place pin flag “D” 50 cm to the south of pin flag “B”

|   |                  |                 |
|---|------------------|-----------------|
| Title: TOS Protocol and Procedure: Plant Belowground Biomass Sampling |                  | Date: 01/22/219 |
| NEON Doc. #: NEON.DOC.014038  | Author: C. Meier | Revision: G     |



**Figure 6.** Delineating the South root sampling area (cross hatched) within a sampling cell (dashed blue lines) with pin flags (*left*). The clip-strip (black lines) lies immediately to the north of the South root sampling area, and the red “x” marks the coordinates provided in the Clip List. The sampling area may also be delineated using a 50cm x 50cm PVC frame (*right*).

6. Mark the four corners of the North root sampling area within the sampling cell to delineate where the second of the two soil samples should be collected (**Figure 7**). Pin flags, PVC frame, or equivalent may be employed. If using pin flags:
  - a. Place pin flag “E” 2 m to the north of pin flag “A”
  - b. Place pin flag “F” 2.5 m to the north of pin flag “A”
  - c. Place pin flag “G” 2 m to the north of pin flag “B”
  - d. Place pin flag “H” 2.5 m to the north of pin flag “B”



**Figure 7.** Delineating the North root sampling area with reference to the previously delineated South root sampling area (cross hatched) within a sampling cell using pin flags (dashed blue lines indicate the clip cell boundary). The middle of both the cell and the clip-strip have been omitted for clarity.

|   |                  |                 |
|---|------------------|-----------------|
| Title: TOS Protocol and Procedure: Plant Belowground Biomass Sampling |                  | Date: 01/22/219 |
| NEON Doc. #: NEON.DOC.014038  | Author: C. Meier | Revision: G     |

7. Within one of the targeted root sampling areas, identify the exact location from which the soil sample will be collected, and determine the **Root Sampling Method** ('core' or 'monolith').
  - a. To avoid rocks and roots that may interfere with coring, probe the ground within the target sampling area with a chaining pin to determine a suitable location.
  - b. If it appears possible to collect a sample to 30 cm:
    - i. Assemble the soil core tube, bit, retainer basket (if necessary), and drive head (see Appendix D), and prepare to collect a **soil core sample**.
    - ii. Note that the corer will handle infrequent smaller diameter rocks (2-5 cm diameter), but cannot handle rocks of this size when they are abundant.
    - iii. You will develop site-specific intuition as to when probing indicates coring is possible.
  - c. If collecting a sample to 30 cm depth appears impossible – i.e., probing reveals there is no place within the target coring area where the corer could be inserted without encountering obstacles before reaching 30 cm depth:
    - i. Prepare to collect a **soil monolith sample** (10cm x 10cm surface area, 30 cm target depth).
    - ii. Note that the soil corer can reliably cut through roots up to 1 cm diameter and larger. If you encounter roots of this size, coring is still the preferred collection method.
8. If it is **NOT** possible to collect a soil sample from a soil sampling area, AND the sampling cell is deemed representative of the plot, follow (a) – (c) below; otherwise proceed to the next step.
  - a. Use the tablet to create a record for the **Plot ID** and **Clip Cell Number**, and create a child-record to record the 'Core Field Data' for the appropriate sampling area ('North' or 'South').
  - b. Select **Root Sampling Possible** = 'No', and save the child record.
  - c. Return to step (7) above, and attempt to collect a sample from the remaining soil sampling area within the clip cell.
9. Create a label for the sample with the information below.
  - a. Label information:
    - **Plot ID** and **Clip Cell Number**, e.g., UKFS047042
    - **Collect Date**, YYYYMMDD format
    - **Core ID**, *North* or *South*
    - **Subplot ID**,  
 for 20m x 20m plots, subplotID = 31  
 for 40m x 40m plots, subplotID = 21, 23, 39, or 41
  - b. **Option A:** Fill in the pre-printed, pre-affixed label on the bag (see **Figure 4**, right)

|   |                  |                 |
|---|------------------|-----------------|
| Title: TOS Protocol and Procedure: Plant Belowground Biomass Sampling |                  | Date: 01/22/219 |
| NEON Doc. #: NEON.DOC.014038  | Author: C. Meier | Revision: G     |

c. **Option B:**

- i. Add required information to the blank, pre-cut weatherproof paper label.
- ii. The label and the soil sample will then be placed in a large plastic freezer bag.

10. If root biomass from a *Toxicodendron spp.* is likely present in the sampling area:



- a. Follow the guidelines established in TOS Standard Operating Procedure: Toxicodendron Biomass and Handling (RD[08]) to minimize exposure to toxic oils and for guidance on how to clean equipment.
- b. Label sample bags that may contain *Toxicodendron* so that they will be handled with appropriate caution during downstream processing. A sample warning label such as that shown at left may be employed for this purpose.

11. Remove plants and litter from the sampling area, then remove non-root belowground plant parts from the top 3 cm of soil:

- a. Use hand clippers to remove aboveground plant leaves and stems from the exact area from which a sample will be collected, and remove litter down to the soil surface.
- b. Score the ground with the soil core bit or soil knife so it is clear exactly where the soil sample will be collected.
- c. Loosen the soil with a soil knife, and remove the soil from around any perennial non-root plant parts growing within the scored area (e.g. corms, rhizomes, crowns, biological soil crust, etc.).
  - If perennial graminoid crowns are present, remove soil until the transition from crown to root is visible.
  - If biological soil crust is present, score the soil just below the moss/lichen layer and carefully remove the crust. The crust can be placed back over the coring hole on top of the backfill material.
- d. Clip all *non-root* material from within the scored area, and discard.
  - (c) and (d) may be done in the laboratory if field conditions are not conducive.

12. Collect a soil sample to 30 cm maximum depth:

*If using the core sampling method:*

- a. Position the soil core bit back over the scored area, and make sure the soil core assembly is vertical. If the plot is sloped, the soil core assembly should still be vertical.
- b. Use the slide hammer to pound the soil core tube to 30 cm maximum depth (*which should be marked on the soil core tube with electrical tape or similar*).



**Once the soil corer is in the ground, do not turn the unit counter-clockwise, as this will unscrew the bit from the core tube underground, resulting in loss of the bit.**

|   |                  |                 |
|---|------------------|-----------------|
| Title: TOS Protocol and Procedure: Plant Belowground Biomass Sampling |                  | Date: 01/22/219 |
| NEON Doc. #: NEON.DOC.014038  | Author: C. Meier | Revision: G     |

- c. Remove the slide hammer attachment and push the core tube back and forth sharply several times to loosen it within the soil profile.
- d. Remove the core tube from the ground, carefully extract the core into a plastic bag, and place the label inside the bag.

If using the **monolith** sampling method:

- a. Use the soil knife and a ruler to measure and cut a sample with 10cm x 10cm surface area. Use a rubber mallet to drive the soil knife vertically (if necessary).
  - b. Cut and remove soil sample as you work, and place into a plastic bag with a label inside.
    - i. When rocks are encountered, remove when possible.
    - ii. Removal of larger rocks may enlarge the hole. This is acceptable, but soil sample should only be collected from the target 10cm x 10cm area as it extends downward from the surface. The intent is to enable calculation of root density ( $\text{g cm}^{-3}$ ) and root mass per area ( $\text{g m}^{-2}$ ).
  - c. Collect soil and roots from the 10cm x 10cm sampling area down to a maximum depth of 30 cm.
    - i. See **Table 10** if a sampling depth of 30 cm cannot be attained.
13. Use the tablet to create a record in the Belowground Biomass Field app for the sampled **Plot ID** and **Clip Cell Number**, and enter required **Clip Cell** sampling information:
- **Plot ID**; select from the site-specific drop-down list; if using paper data sheets use *SITE\_###* format.
  - **Subplot ID**; for 20m x 20m Tower Plots, subplotID = 31. For 40m x 40m Tower Plots, subplotID = 21, 23, 39 or 41.
  - **Sampling Protocol Version**; select the version of the protocol used for sampling, typically the current released version.
  - **Collect Date/Time**; use *YYYYMMDD* and *HH:mm* 24-h time format. Time is the **local** time the sample was placed in the cooler after collection.
  - **Clip Cell Number**; *###* format. This number is the last 3 digits of the clipID from the Clip List.
14. Create a child record for the **Core ID** (*North* or *South*), and measure and enter the required sampling data.
- a. Obtain the dimensions of the hole from which the sample was collected:

If using the **core** sampling method:

- i. **Core Diameter**; measure the inside diameter of the coring device, nearest 0.05 cm. For the standard corer listed in Section 6.1, the value is 6.65 cm.
- ii. **Root Sample Depth**; measure the average depth below the surface to which the soil sample was collected, nearest 1 cm.
  - Push past any loose soil that fell back into the hole, and measure a representative depth.

|   |                  |                 |
|---|------------------|-----------------|
| Title: TOS Protocol and Procedure: Plant Belowground Biomass Sampling |                  | Date: 01/22/219 |
| NEON Doc. #: NEON.DOC.014038  | Author: C. Meier | Revision: G     |

*If using the **monolith** sampling method:*

- i. **Monolith Length and Monolith Width**; the actual length and width of the 10cm x 10cm surface area from which the sample was collected, nearest 1 cm.
    - Dimensions may be recorded to the nearest 0.1 cm, if possible.
  - ii. **Root Sample Depth**; measure the average depth below the surface to which the soil sample was collected, nearest 1 cm, as above for **core** sampling.
  - b. **Litter Depth**; average litter depth for the entire ‘North’ or ‘South’ soil sampling area, nearest 1 cm.
    - If litter is < 1 cm average depth, record 0.5 cm.
  - c. **Woody Stem Distance, DBH ≥ 10 cm**; distance to closest *living* woody stem with DBH ≥ 10 cm, nearest 0.1 m.
  - d. **Woody Stem Distance, DBH ≥ 1 cm**; distance to closest *living* woody stem with 1 cm ≤ DBH < 10 cm, nearest 0.1 m.
  - e. **Bare Ground**; % of entire ‘North’ or ‘South’ soil sampling area that is made up of soil (particles < 5 mm diameter) and/or rock (mineral particles > 5 mm diameter), nearest 10%.
  - f. **Sample Barcode** (optional); scan in the sample barcode affixed to the waterproof label.
  - g. Save the child record.
15. Place the sample label in the bag, seal, and place the bagged soil sample into cold storage. Maintain cold until samples can be processed in the laboratory.
    - Refresh cold packs every 12 h or transfer cores to a refrigerator in the lab.
  16. Backfill the sample hole with site-host approved material (if required by site host).
  17. Return to step (7) and collect an additional sample from the remaining ‘North’ or ‘South’ sampling area within the clip cell.
  18. Once two samples per cell have been collected, save the parent record for the clipID, and proceed to the next clipID on the list.

|   |                  |                 |
|---|------------------|-----------------|
| Title: TOS Protocol and Procedure: Plant Belowground Biomass Sampling |                  | Date: 01/22/219 |
| NEON Doc. #: NEON.DOC.014038  | Author: C. Meier | Revision: G     |

### B.3 Troubleshooting

**Table 10.** Potential issues encountered during plant Belowground Biomass Core sampling, and issue resolution.

| Issue  | Resolution   |
|--|--|
| 30 cm depth not reached due to obstacles                         | <ul style="list-style-type: none"> <li>• Attempt sample collection at up to 3 total locations within the target coring area.</li> <li>• Collect a sample to the greatest depth possible.</li> <li>• Record the final sampling depth.</li> </ul>  |
| A sample cannot be collected from a representative sampling area | <ul style="list-style-type: none"> <li>• Record <b>Root Sampling Possible</b> = ‘No’</li> <li>• Move on to the next sampling area within the clip cell, the next clipID or the next plotID, whichever is applicable.</li> </ul>  |
| Flooded plot   | <p>Resolution strategies in order of preference:</p> <ol style="list-style-type: none"> <li>1. Schedule plant belowground biomass sampling at a time of year when probability of flooding is minimized and potentially decouple from Herbaceous Biomass clip-harvest sampling (Section 4.2).</li> <li>2. Attempt to collect soil samples from plots with water &lt; 30 cm depth.               <ol style="list-style-type: none"> <li>a. Use the basket adapter with sandy soils if this would be helpful to prevent soil falling out of the collection tube.</li> <li>b. Keep sample if soil is cohesive enough such that either of the following are true:                   <ol style="list-style-type: none"> <li>i. The bore hole can be accurately measured for sampling depth (equivalent to sample length).</li> <li>ii. The sample itself can be accurately measured for length.</li> </ol> </li> <li>c. Discard sample if the depth of the bore hole or the length of the sample cannot be reasonably measured. That is, discard the sample if either the bore hole has collapsed and/or filled with sediment, or the sample lacks structural integrity and cannot be measured.</li> </ol> </li> </ol> |



|   |                  |                 |
|---|------------------|-----------------|
| Title: TOS Protocol and Procedure: Plant Belowground Biomass Sampling |                  | Date: 01/22/219 |
| NEON Doc. #: NEON.DOC.014038  | Author: C. Meier | Revision: G     |

#### B.4 Sample Preservation

- Keep samples in a cooler with cold packs to minimize cellular activity, reduce decomposition, and preserve sample mass.
- Change cold packs for fresh ones every 12 h or transfer to a 4-8 °C refrigerator prior to laboratory processing.
- Soil samples must be processed in the laboratory **within 72 h** of collection in the field.

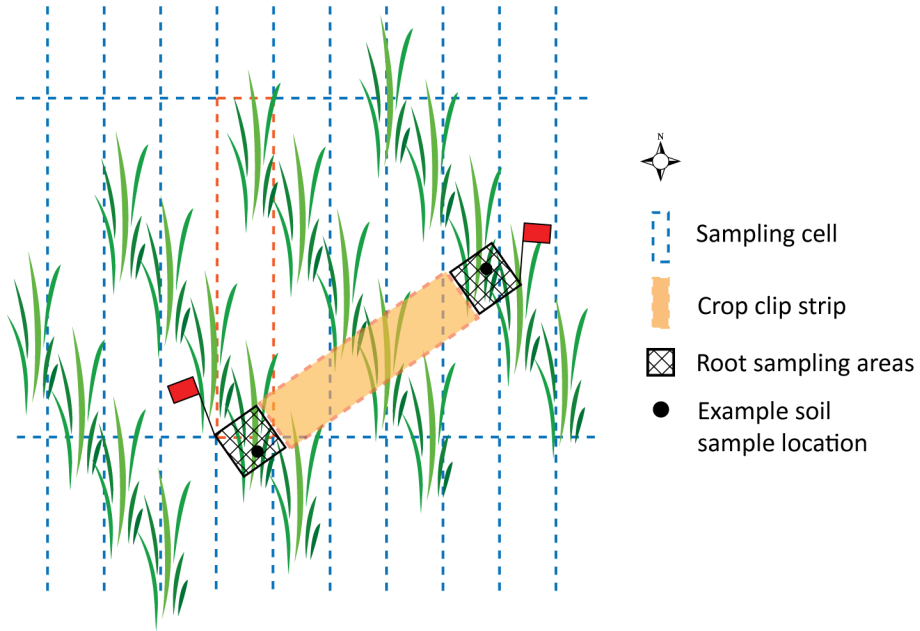
**IMPORTANT:** Record the **Collect Date** and **time** in the Field app AND **Oven Start Date** and **time** in the Lab Weighing app so that the number of hours the samples were stored cold can be calculated.

#### B.5 Plant Belowground Biomass at Agricultural Sites

Delineation and flagging of sampling areas for both Plant Belowground Biomass Sampling and the Agricultural Biomass SOP should be carried out at the same time regardless of which protocol is executed first.

1. Bring a 3 m long folding ruler, or equivalent rigid measuring device, and 0.5m x 0.5m frames used to lay out the belowground biomass sampling areas.
2. Locate the SW corner of the clip strip as in SOP B.2. At agricultural sites, *this Clip List coordinate will serve as the SW corner of the clip cell rather than the clip strip.*
3. Rotate clockwise until you are facing perpendicular to crop rows (**Figure 8**).
4. Use the rigid measuring stick to lay out the 3 m long left side of a 3.0m x 0.5m clip cell.
5. Use the 0.5m x 0.5m frames to layout the plant belowground biomass sampling areas at either end of the clip cell. Flag the lower-left corner of the cell and the upper-right corner of the cell.
  - a. Flagging should remain if soil sampling occurs prior to agricultural clip harvest.
6. Delineate a clip strip of the appropriate dimensions; the long edge of the clip strip should remain perpendicular to crop rows (**Figure 8**).

|   |                  |                 |
|---|------------------|-----------------|
| Title: TOS Protocol and Procedure: Plant Belowground Biomass Sampling |                  | Date: 01/22/219 |
| NEON Doc. #: NEON.DOC.014038  | Author: C. Meier | Revision: G     |



**Figure 8.** Modified sampling cell layout when integrating plant belowground biomass sampling and herbaceous biomass clip harvest at agricultural sites. Orange dashes indicate the rotated clip cell. The red flag on the left is placed at the coordinate provided in the Clip List.

|   |                  |                 |
|---|------------------|-----------------|
| Title: TOS Protocol and Procedure: Plant Belowground Biomass Sampling |                  | Date: 01/22/219 |
| NEON Doc. #: NEON.DOC.014038  | Author: C. Meier | Revision: G     |

## SOP C Processing Belowground Biomass Samples in the Laboratory

### Goals

- Isolate fine roots from soil, sort to **Size Category** and **Root Status**, then dry and weigh.
- For live roots, grind dried biomass and ship to external facilities for chemical analysis and bioarchive (latter only if sufficient sample).
- Collect required laboratory data.
  - The preferred methods for data collection are the Belowground Biomass Lab Weighing and Belowground Biomass Grind and Pool mobile applications.
  - The Belowground Biomass Sampling Fulcrum Manual on the SSL contains detailed data entry instructions.

### Gloves

Fine root samples generated from this procedure are analyzed for isotopes (<sup>13</sup>C and <sup>15</sup>N); as such, disposable latex or nitrile gloves are required during sieving, sorting, and grinding tasks to prevent contamination of the sample with your hands. Gloves also prevent exposure to *Toxicodendron* roots.

### Overview

Use time estimates for lab processing steps provided in Section 6.4 to plan field work so that a backlog of soil samples does not develop, and the **72 h maximum cold storage** requirement can be met. Time sensitive processing steps include:

1. Determine whether soil samples will be wet-sieved or dry-sieved.
  - **Wet-sieving:** If the soil samples have a large amount of root mass, soils are finely textured, or the soil is difficult to break apart by hand without fragmenting roots, wet-sieving may be the most efficient procedure for separating roots from soil.
    - Soak hard and/or clay-rich soil samples for 1-12 h before wet-sieving.
  - **Dry-sieving:** If the soil samples have little root mass and are coarsely textured, or soils are coarsely textured and the roots are very brittle, dry-sieving soils may be the most efficient procedure.
2. Wash and sieve soil cores to separate mineral soil from root biomass and organic matter, and separate roots  $\geq 1$  cm length from the residual fraction.
3. Set aside the residual fraction from a random subset of 20 samples for processing with 0.
  - See the 'Overview' section at the beginning of 0 for guidance on randomly selecting samples for dilution sampling.
  - It is acceptable to pause overnight between execution of SOP C and SOP D. Store labeled residual fractions overnight at 4 °C in a sealed container (e.g., labeled 50 mL tube).
4. Dry fine root biomass  $\geq 1$  cm length to constant weight.

|   |                  |                 |
|---|------------------|-----------------|
| Title: TOS Protocol and Procedure: Plant Belowground Biomass Sampling |                  | Date: 01/22/219 |
| NEON Doc. #: NEON.DOC.014038  | Author: C. Meier | Revision: G     |

Once roots are dry, time is no longer of the essence, and the following may be completed as time allows:

5. Weigh and record dry weight biomass.
6. Grind fine root samples for chemical analyses.

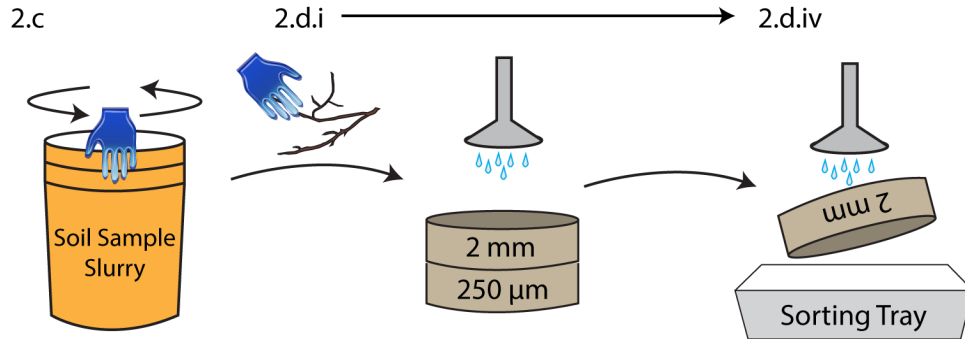
**C.1 Sieving soil samples for fine root biomass**

**C.1.1 Wet Sieving Soils**

1. For wet sieving:
  - For hard, dry and/or clay-rich soils: Soak the sample in water for a minimum of 1 hour in a 5 gallon plastic bucket, or appropriately sized container, to facilitate breaking up the sample. Water depth should be sufficient to cover the soil.
  - Soil samples may also soak overnight in the bucket to facilitate workflow scheduling.
  - Transfer the adhesive label from the field sample bag to the bucket. A duct tape ‘tab’ on the bucket handle can be used as a place to stick the label.
  - **Optional Soil Sample Barcodes** (from the field): Retain the barcode and group with downstream root subsamples when they are placed in the oven for drying.
2. Separate roots and soil organic matter (OM) from mineral soil by wet sieving. Before beginning the wet-sieving routine, determine whether the soil sample has been selected for Dilution Sampling (0).
  - a. Label a sorting container with the sampleID. Include ‘D’ on the label if the sample will be processed for Dilution Sampling via 0.
    - i. The adhesive label from the field can be transferred again from the bucket to the sorting container (minimizes transcription errors).
    - ii. Two sorting containers may be useful: One for roots from the 2 mm sieve, and the other for roots from the 250 µm sieve.
  - b. Massage the sample in the bucket with gentle manual pressure to break up large aggregates and OM pieces.
  - c. Thoroughly mix the slurry in the bucket by hand to separate small roots from mineral soil particles. At this point, roots and small pieces of (OM) should be floating on the surface.
  - d. Remove large roots from the surface of the slurry (**Figure 9**).
    - i. Assemble the sieve stack; the 2 mm sieve should be on top of the 250 µm sieve, and the stack should be placed over one of the washing station grates.
    - ii. Using hands or forceps, pick large visible roots from the bucket and place in the 2 mm sieve (i.e., the top of the sieve stack).

|   |                  |                 |
|---|------------------|-----------------|
| Title: TOS Protocol and Procedure: Plant Belowground Biomass Sampling |                  | Date: 01/22/219 |
| NEON Doc. #: NEON.DOC.014038  | Author: C. Meier | Revision: G     |

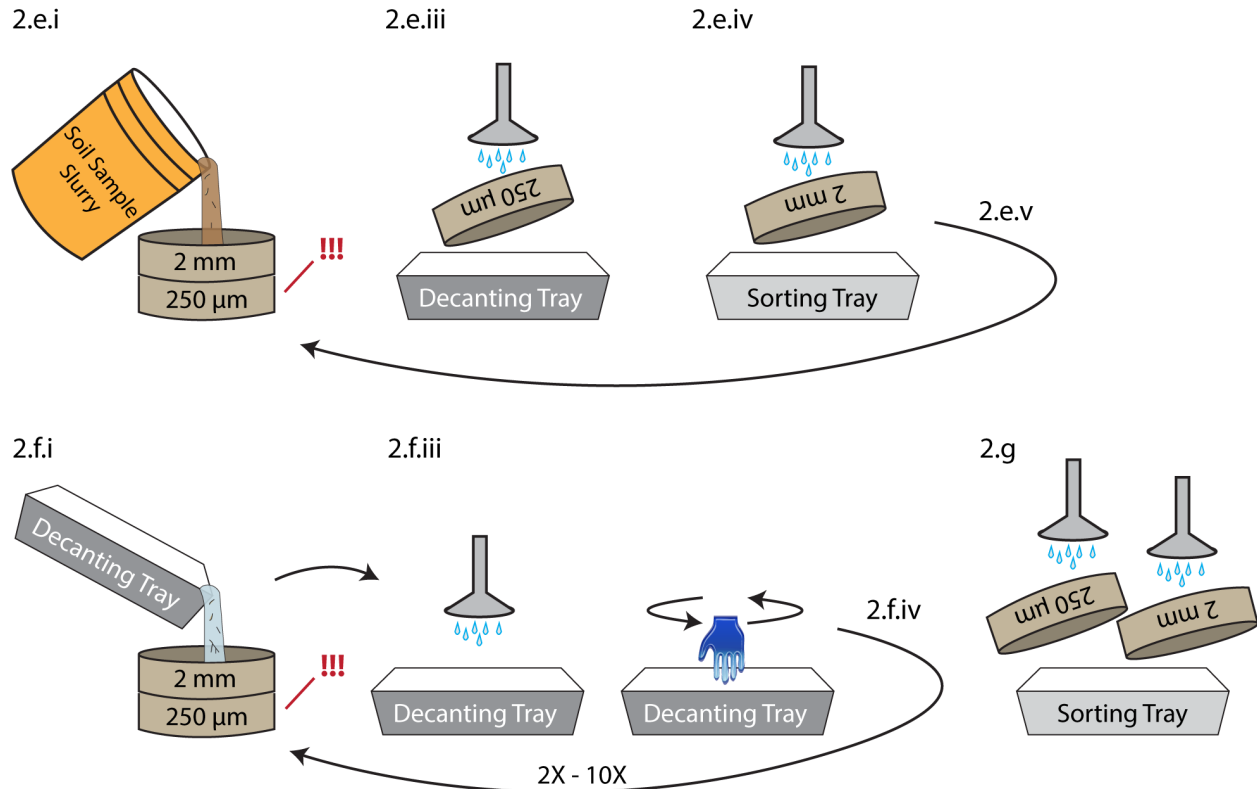
- iii. Wash mineral particles from the roots and be sure to rinse hands over the stack so as not to lose root particles.
- iv. Transfer clean roots to a sorting container with water and lid – i.e., a clear plastic bin, white enamel pan or equivalent (**Figure 10**). Sorting is carried out in a subsequent step.



**Figure 9.** Manual removal of large roots from the surface of the soil sample slurry, followed by transfer from the 2 mm sieve to the sorting tray. Numbers correspond to protocol steps above.



**Figure 10.** Example of a plastic bin sorting container with a small amount of water to aid root separation.



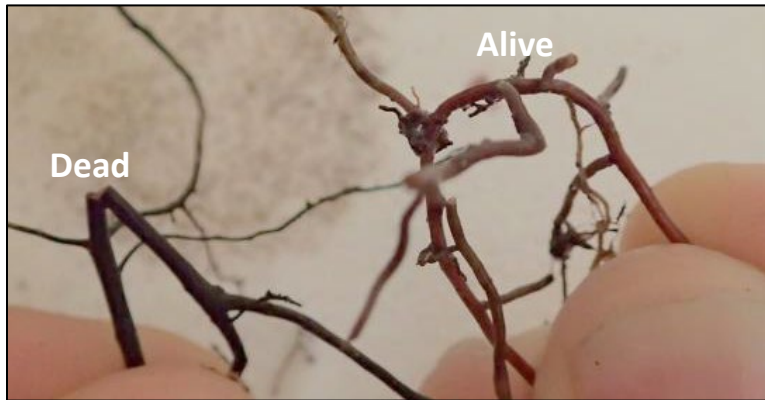
**Figure 11.** Wet-sieving the soil sample slurry (*step 2e*) followed by decanting the 250  $\mu\text{m}$  sieve contents to separate organic material and roots  $\geq 1$  cm length from mineral soil (*step 2f*). Mineral soil remains in the decanting tray, and roots and organic material are transferred to the sorting tray (*step 2g*).

- e. Once large roots have been picked from the surface of the slurry, pour PART of the slurry through the top of the sieve stack. This will begin to separate remaining roots and OM from mineral soil (**Figure 11**).
  - i. BE CAREFUL NOT TO OVERFLOW THE 250  $\mu\text{m}$  SIEVE!
  - ii. Quickly remove large rocks from the surface of the 2 mm sieve as you go.
  - iii. When the 250  $\mu\text{m}$  sieve is full, transfer the entire contents into a large plastic bin, tray, or equivalent for decanting and separation of mineral particles. Set aside the contents in the decanting bin until the entire soil sample has been passed through the sieve stack.
  - iv. When checking the 250  $\mu\text{m}$  sieve, rinse roots trapped in the 2 mm sieve and transfer clean roots from the 2 mm sieve into the sorting container from step (2.d.iv); transfer by turning the 2 mm sieve upside-down over the sorting container and using the washing station nozzle.

|   |                  |                 |
|---|------------------|-----------------|
| Title: TOS Protocol and Procedure: Plant Belowground Biomass Sampling |                  | Date: 01/22/219 |
| NEON Doc. #: NEON.DOC.014038  | Author: C. Meier | Revision: G     |

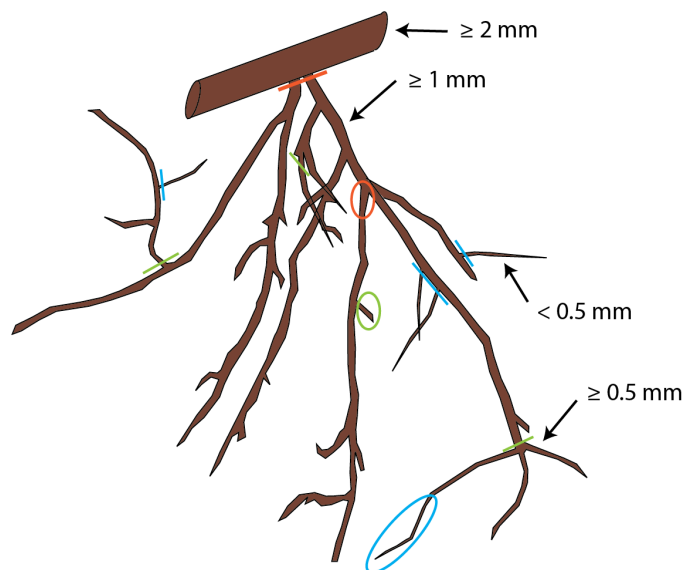
- v. Continue pouring aliquots of the sample slurry from the bucket through the sieve stack, repeating (i)-(iv) immediately above, until the entire sample has passed through the stack.
  - f. Once the entire sample from the bucket has been passed through the sieve stack, place the clean 2 mm sieve back on top of the 250  $\mu\text{m}$  sieve and decant the material that was set aside in the bin/tray in step (2.e.iii) back through the sieve stack. Mineral particles should be retained in the bin/tray (**Figure 11**).
    - i. To decant, let the mineral soil settle to the bottom then carefully but quickly pour off the water, roots and OM from the top and into the sieve stack.
    - ii. BE CAREFUL NOT TO OVERFLOW THE 250  $\mu\text{m}$  SIEVE!
    - iii. Add more water to the bin/tray, and stir into a slurry to release more roots and OM from the mineral soil.
    - iv. Continue to rinse and pour through the sieve stack until only mineral soil is in the bin/tray. This may require between 2-10 rinses depending on soil type.
  - g. Transfer washed roots from both sieves to the sorting container (**Figure 11**).
3. (*OPTIONAL*) It is acceptable to pause overnight between sieving and beginning the sorting process provided that:
- a. The sample is kept refrigerated and sealed in a plastic bag with a label. For example, the entire sorting container may be covered with a plastic bag or plastic wrap with the waterproof label inside and then placed in the refrigerator, AND
  - b. No longer than 72 h elapses between sample collection in the field and beginning sorting.
4. Use forceps to pick all roots  $\geq 1$  cm length from the sorting container, and sort to **Size Category** and **Root Status** as you go.
- o Use a wire gauge to determine the **Size Category**; the largest diameter of a root fragment should be used to classify the size.
  - o **VERY IMPORTANT:**
    - To determine root diameter, you must pass the root through the gap *in the side* of the wire gauge; DO **NOT** insert the root through the larger hole.
    - Calipers must be used to determine whether large roots are  $\leq 10$  mm diameter.
  - o The wire gauge may be mounted on the side of the sieve using one of the larger gaps, enabling quick access for size classification.

- If only part of a root is alive, categorize the entire root as “live.” Dead roots are most often dark brown or black and brittle, while live roots are often lighter in color and flexible – i.e., they can typically be bent into a “U” shape without breaking (**Figure 12**).



**Figure 12.** Example of a dead root (*left*) and a live root (*right*). Within a species, dead roots are typically darker and more brittle than live roots. Live roots may often be bent into a ‘U’ shape without breaking.

5. Clip apart branched root systems into respective **Size Category** classes (see **Figure 13**):
  - Clip only at branch points.
  - **Size Category** is assessed at the largest end of the clipped segment.
  - Do not clip at a given branch point if there are no ‘downstream’ changes in **Size Category**.
  - Ignore branches that result in root fragments < 1 cm length.



**Figure 13.** Clipping a branched root system to Size Category. The orange bar indicates where two 1-2mm diameter roots are clipped from a  $\geq 2$ mm diameter root; the green bars indicate where 0.5-1mm diameter roots are clipped from larger roots; the blue bars indicate where roots < 0.5mm diameter are clipped from larger roots. The orange



|   |                  |                 |
|---|------------------|-----------------|
| Title: TOS Protocol and Procedure: Plant Belowground Biomass Sampling |                  | Date: 01/22/219 |
| NEON Doc. #: NEON.DOC.014038  | Author: C. Meier | Revision: G     |

circle is not clipped because there are no downstream changes in Size Category; the green circle is not clipped because the fragment is < 1 cm length; the blue circle is not clipped because even though diameter within the circle is < 0.5mm, Size Category is assessed at the largest end, and clipping only occurs at branch points.

6. For each soil sample, label up to 8 coin envelopes with the information below. The total number needed depends on the number of **Root Status** x **Size Category** combinations in the sample. For large amount of root biomass within a given size class, use a clasp envelope instead.

- a. For samples that may contain Toxicodendron roots:
  - i. Add sample warning label to envelope, such as that shown at left.
  - ii. Dry in a 65 °C oven for 1 h, then let cool to room temperature in a desiccator.
  - iii. Weigh each empty envelope using the same high-precision microbalance that is used for roots (0.001 or 0.0001 g accuracy), and record the empty envelope mass on the envelope.
  - iv. Clean durable equipment that may have contacted *Toxicodendron* tissue (e.g., sieves, forceps) as described in RD[12].



**Optional Root Subsample Barcodes:** A minimum of one root envelope per soil sample may be pre-labeled with a Type I barcode, in addition to human-readable information.

- **Plot ID and Clip Cell Number**, e.g., SRER047042
- **Collect Date**, date roots were sampled in the field; YYYYMMDD format
- **Core ID**, either 'North' or 'South'
- **Size Category**, 0-05, 05-1, 1-2, 2-10
- **Root Status**, 'Live' or 'Dead'
- **Plot ID and Subplot ID**,
  - for 20m x 20m plots, subplotID = 31;
  - for 40m x 40m plots, subplotID = 21, 23, 39, or 41
- **Example label text:** SRER047042.20180714.North.0-05.Live, subplot=21

- 7. Place sorted roots into the labeled envelopes.
- 8. **If the sample has been randomly selected for dilution sampling**, set aside the residual fraction for processing via 0 (i.e., root fragments < 1 cm mixed with organic material).
  - a. See 0, step (1) for guidance on randomly selecting cores for dilution sampling.
  - b. Create a record in the Belowground Biomass Lab Dilution app for the Dilution Sample that will be generated from the soil Sample ID.
  - c. Select required plot-level and soil sample information to identify the Dilution Sample.
    - i. **Optional barcode workflow:** scan the Sample ID barcode from the field to populate the record with required plot and sample data.

|   |                  |                 |
|---|------------------|-----------------|
| Title: TOS Protocol and Procedure: Plant Belowground Biomass Sampling |                  | Date: 01/22/219 |
| NEON Doc. #: NEON.DOC.014038  | Author: C. Meier | Revision: G     |

- d. Save the Lab Dilution record.
- 9. Thoroughly clean the sieves and enamel pan with water between core/monolith samples.
- 10. Check sediment traps in the root washing station; if traps are full, dispose of sediment in an approved receptacle.
  - a. Pouring off water in the morning after sediment has settled overnight is an effective method for retaining as much sediment as possible in the buckets prior to disposal.
- 11. Gather roots from the same soil sample together to keep them organized. For example:
  - a. Place envelopes containing root samples into a paper bag to keep samples organized (lunch sack size works well); OR
  - b. If there are very few roots, coin envelopes may be paper clipped together.
  - c. **Optional Barcode Workflow:**
    - i. Keep the physical barcode originally associated with the field-collected soil sample – i.e., the Sample ID barcode on weatherproof paper – with the root subsamples as they are dried and weighed.
    - ii. The Sample ID barcode will aid in bringing up the correct record during Dry Mass data entry.

|   |                  |                 |
|---|------------------|-----------------|
| Title: TOS Protocol and Procedure: Plant Belowground Biomass Sampling |                  | Date: 01/22/219 |
| NEON Doc. #: NEON.DOC.014038  | Author: C. Meier | Revision: G     |

### C.1.2 Dry Sieving Soils

1. Process soils using the different sized sieves as you would with the wet-sieving procedure, but do not apply water.
2. Use a 2 mm sieve, a 250  $\mu$ m sieve, and a pan bottom. Pass the sample through the sieve stack to separate roots from mineral soil and soil organic matter, and then transfer roots to a white enamel pan for picking.
  - a. The 2 mm sieve is useful for catching and removing large rocks from the sample, as well as larger roots
  - b. The 250  $\mu$ m sieve is useful for capturing any roots that have passed through the 2 mm sieve. Roots  $\geq$  1 cm in length are not likely to pass through this finer mesh.
  - c. The white pan can be used to more easily differentiate small roots in the 250  $\mu$ m soil fraction.
3. From each sieve and the enamel pan, separate fine roots  $\geq$  1 cm in length from mineral soil and organic matter.
  - a. It is often helpful to pass no more than 10 – 20% of the sample through the sieve stack, as it makes it easier to spot roots.
  - b. Break up aggregates and organic matter pieces using gentle manual pressure.
  - c. Manually remove larger rocks from the top of the 2 mm sieve – but don't spend more than several minutes.
4. Use forceps to pick all roots  $\geq$  1 cm length from the enamel pan, sorting to **Size Category** and **Root Status** as you go; alternatively, you may sort to **Size Category** and **Root Status** after all roots  $\geq$  1 cm in length have been picked.
  - a. Use a wire gauge to determine the **Size Category**; the largest diameter of a root fragment should be used to classify the size.
  - b. **VERY IMPORTANT:** To determine root diameter, you must pass the root through the gap *in the side* of the wire gauge; DO NOT insert the root through the larger hole.
  - c. The wire gauge may be mounted on the side of the sieve using one of the larger gaps, enabling quick access for size classification.
  - d. If only part of a root is alive, categorize the entire root as "live." Live roots are most readily distinguished from dead roots on the basis of color and friability; dead roots are often dark brown or black and brittle, while live roots are often lighter in color and flexible – i.e., they can typically be bent into a "U" shape without breaking.
  - e. Place sorted roots into the pre-labeled envelopes created in step (**Error! Reference source not found.**).
  - f. **If the sample has been randomly selected for dilution sampling**, set aside the residual fraction (i.e., root fragments < 1 cm mixed with organic material) for processing via 0.
  - g. Clean the 250  $\mu$ m sieve and repeat all of step (4) until the entire sample has been processed through the sieve stack.

|   |                  |                 |
|---|------------------|-----------------|
| Title: TOS Protocol and Procedure: Plant Belowground Biomass Sampling |                  | Date: 01/22/219 |
| NEON Doc. #: NEON.DOC.014038  | Author: C. Meier | Revision: G     |

5. Once all roots >1 cm in length have been picked and sorted, wash sediment from roots by using a clean 250 µm sieve. Sediment clinging to roots can significantly inflate weighed root biomass; thus the importance of gently washing dry roots once they are sieved.
  - a. Place a sorted group of roots into the 250 µm sieve and gently run water over the roots.
  - b. Use forceps to transfer the roots to a labeled coin envelope.
  - c. Repeat the above steps (a-b) for the remaining root samples.
  
6. For each soil sample, label up to 8 coin envelopes with the information below. The total number needed depends on the number of **Root Status** x **Size Category** combinations in the sample. For large amounts of root biomass within a size class, use a clasp envelope instead.
  - a. For samples that may contain *Toxicodendron* roots:
    - i. Add sample warning label to envelope, such as that shown at left.
    - ii. Dry in a 65 °C oven for 1 h, then let cool to room temperature in a desiccator.
    - iii. Weigh each empty envelope using the same high-precision microbalance that is used for roots (0.001 or 0.0001 g accuracy), and record the empty envelope mass on the envelope.
    - iv. Clean durable equipment that may have contacted *Toxicodendron* tissue (e.g., sieves, forceps) as described in RD[12].



**Optional:** Envelopes may be pre-labeled with a Type I barcode, in addition to human-readable information.

- **Collect Date**, date roots were sampled in the field; YYYYMMDD format
  - **Plot ID** and **Subplot ID**,
    - for 20m x 20m plots, subplotID = 31;
    - for 40m x 40m plots, subplotID = 21, 23, 39, or 41
  - **Clip Cell Number**, the 3 digits to the right of the last “\_” in the clipID on the Clip List
  - **Core ID**, either ‘North’ or ‘South’
  - **Root Status**, ‘Live’ or ‘Dead’
  - **Size Category** (<0.5, 0.5-1, 1-2, 2-10)
7. Place sorted roots into labeled envelopes.

|   |                  |                 |
|---|------------------|-----------------|
| Title: TOS Protocol and Procedure: Plant Belowground Biomass Sampling |                  | Date: 01/22/219 |
| NEON Doc. #: NEON.DOC.014038  | Author: C. Meier | Revision: G     |

8. Gather sorted roots from the same soil sample together to keep them organized. For example:
  - a. Place envelopes containing root samples into a paper bag to keep samples organized (lunch sack size works well); OR
  - b. If there are very few roots, coin envelopes may be paper clipped together.
  - c. **Optional Barcode Workflow:**
    - i. Keep the physical barcode originally associated with the field-collected soil sample – i.e., the Sample ID barcode on weatherproof paper – with the root subsamples as they are dried and weighed.
    - ii. The Sample ID barcode will aid in bringing up the correct record during Dry Mass data entry.
9. Thoroughly clean the sieves and enamel pan with water between soil samples.

|   |                  |                 |
|---|------------------|-----------------|
| Title: TOS Protocol and Procedure: Plant Belowground Biomass Sampling |                  | Date: 01/22/219 |
| NEON Doc. #: NEON.DOC.014038  | Author: C. Meier | Revision: G     |

## C.2 Drying, weighing, and processing belowground biomass samples

Washed roots should be placed in the drying oven as soon as possible following sieving.

1. Label groups of envelopes containing washed roots from the same soil sample with the date and time they are placed in the drying oven.
  - These data are the **Oven Start Date** and **Time** required during data entry.
  - **Critical step:** Labeling bags allows assessment of how long different batches of bags have been in the oven, especially when roots sampled on different days occupy the same oven.
2. Place labeled bags into a drying oven for a minimum of 48 h (longer is okay, but not required).
  - Dry all root diameters at 65 °C.
3. Remove bags of dried biomass from the drying oven, and label bags with **ovenOutDate/Time**.
  - After removing from the drying oven, dried roots should be weighed as soon as they have returned to room temperature. Roots will absorb moisture from the air if left in ambient room conditions (particularly in humid environments).
    - If using this method, it is helpful to remove bags from the oven and weigh one at a time.
    - Dried roots should be placed in a desiccator to cool and may be weighed one at a time from the desiccator. A makeshift desiccator can be constructed from a large tupperware with a layer of drying crystals in the bottom.
  - Dried samples may also be stored for up to 30 days in ambient room conditions prior to weighing. Samples treated in this manner must be returned to the drying oven for 24 h prior to weighing, and must be weighed as above after removal from the oven.
    - If samples were initially dried and kept in storage, it is not necessary to record any additional drying times.
4. Organize all samples from the same **Plot ID**.
  - Weighing samples from the same **Plot ID** at the same time, and keeping samples grouped, will greatly facilitate subsequent grinding and pooling steps (SOP C.4).
5. Weigh each fine root sample using a mass balance (minimum 0.001 accuracy) and a weigh boat. Balances with glass doors are required because samples are very light and air currents may affect perceived sample mass.
  - a. For large volumes of biomass that do not readily fit into a large weighboat, use the following strategies:
    - i. Use a large plastic tray (or equivalent) instead of a weigh boat (see equipment list).
    - ii. Crush or chop the biomass to reduce volume so it will fit into a weigh boat.

|   |                  |                 |
|---|------------------|-----------------|
| Title: TOS Protocol and Procedure: Plant Belowground Biomass Sampling |                  | Date: 01/22/219 |
| NEON Doc. #: NEON.DOC.014038  | Author: C. Meier | Revision: G     |

- iii. Avoid splitting the biomass into subgroups for weighing, as uncertainty values must be added each time a subgroup is created.
- b. Aluminum weigh pans may be employed when weighing small masses of roots that may be affected by static when weighed with a plastic weigh boat.
- c. For samples that may contain *Toxicodendron* roots:



- i. These sample envelopes should have a warning label such as that shown at left. Do NOT remove the root biomass from the envelope.
- ii. Weigh the envelope + roots and record the total mass to 0.001 or 0.0001 g on the envelope.
- iii. Use a spreadsheet calculator to calculate:  $\text{dryMass} = (\text{envelope} + \text{roots}) - \text{envelope}$ .

6. Enter data in the Belowground Biomass Lab Weighing app (next step).

**Optional workflow:** Record data on the 'Lab Weighing' data sheet, then transcribe into the Lab Weighing app.

7. In the Lab Weighing app, create a record for each **Plot ID**, **Subplot ID** and **Date** combination (i.e., Clip Cell), and enter required parent-level data:
- a. **Optional Barcode Workflow:** Scan the Sample ID barcode from the field to rapidly select the desired **Plot ID**, **Subplot ID** and **Date** for the record.
  - b. **Site ID;** the site from which root samples were collected (auto-populated if using barcodes).
  - c. **Plot ID;** from the list, select the plot, subplot and date associated with the root samples (auto-populated if using barcodes).
  - d. **Sample Mass Presence;** For each Soil Sampling Area (**North** and **South**), indicate which Size Category x Root Status combinations are present in the sample.
    - i. If no roots were found, select '**No (zero)**' mass for that category/status combination.
  - e. Create a child-level record for each dried root sample from a given Clip Cell, and enter:
    - i. **Oven Start Date/Time;** date (YYYYMMDD format) and time (24-h format) the sample was initially placed in the drying oven.
      - Enter only for initial drying event. Do not enter additional dates/times for samples stored at room temperature, and then re-dried prior to weighing.
    - ii. **Oven End Date/Time;** date and time the sample was initially removed from the drying oven.
    - iii. **Weigh Date;** date Dry Mass was weighed for the sample, YYYYMMDD format.

|   |                  |                 |
|---|------------------|-----------------|
| Title: TOS Protocol and Procedure: Plant Belowground Biomass Sampling |                  | Date: 01/22/219 |
| NEON Doc. #: NEON.DOC.014038  | Author: C. Meier | Revision: G     |

- iv. **Dry Mass**; dried root sample mass, greatest precision possible (0.001 or 0.0001 g)
  - v. **Sub-Sample Fate**; defaults to 'active'. Select other value as appropriate.
  - vi. **Optional Barcode Workflow**: Link barcode(s) with a minimum of one root subsample for which Sample Mass Presence = 'Yes'.
  - vii. Save child-level record.
- f. Repeat step (6.d) for all root samples from the same soil sample.
  - g. Save the parent-level record.
8. Once all masses have been recorded for a given sampling bout:
- a. Perform QA on a subset of samples (SOP 0), or
  - b. Return dried fine roots to temporary storage in a desiccator at ambient conditions. Samples in temporary storage can then be weighed for QA as time permits.



|   |                  |                 |
|---|------------------|-----------------|
| Title: TOS Protocol and Procedure: Plant Belowground Biomass Sampling |                  | Date: 01/22/219 |
| NEON Doc. #: NEON.DOC.014038  | Author: C. Meier | Revision: G     |

### C.3 Data Quality Assurance

To quantify uncertainty associated with weighing dried biomass, a random selection of dried samples are re-weighed by a different technician than the person who originally weighed the biomass.

1. For each sampling event at a given site, randomly select 10% of dried, previously weighed samples for re-weighing.
  - a. If QA weighing does not occur within 1 hour of the initial weighing, return the selected samples to the drying oven for 24 h prior to QA weighing. In humid environments, samples will pick up moisture from the atmosphere.
2. For root samples selected for QA, select the appropriate parent record in the Belowground Biomass Lab Weighing app, and edit to create a new child-level **'QA'** record.

***If using the optional barcode workflow:*** Scan the field Sample ID barcode (**Figure 3**) from which the root subsample for which QA is desired. This will bring up the appropriate parent-level Lab Weighing record.

3. Enter required data into the new QA child-level record:
  - a. **QA Dry Mass**; select the 'Y' option from the drop-down.
  - b. **QA Sample List**; select the root subsample for which QA Dry Mass will be recorded from the list of previously weighed and entered root masses.
  - c. **Weigh Date**; date QA Dry Mass was weighed, *YYYYMMDD* format.
  - d. **Dry Mass**; dried QA root sample mass, greatest precision possible (0.001 or 0.0001 g)
  - e. Save the child-level QA record.
  - f. Save the parent record.
4. Return to step (2) above for additional QA samples.
5. After QA weighing, return plant material to temporary storage.

|   |                  |                 |
|---|------------------|-----------------|
| Title: TOS Protocol and Procedure: Plant Belowground Biomass Sampling |                  | Date: 01/22/219 |
| NEON Doc. #: NEON.DOC.014038  | Author: C. Meier | Revision: G     |

## C.4 Grinding and Pooling Biomass for Chemical Analysis and Archive

### Overview

1. **Which samples are processed:** A subset of dried root samples are processed for chemical analysis and archive once QA masses have been recorded:
  - a. Samples with Root Status = **'live'** ***must be processed for chemical analysis***, and possibly archive (if there is sufficient sample).
  - b. Samples with Root Status = **'dead'** *are not processed further*, and may be discarded once data have been successfully entered to the NEON database and have been checked for data entry errors.
2. **How samples are processed:** Pooled root samples are created and then the pooled sample is split for shipment to chemical analysis and archive facilities (see **Figure 3**).
  - a. To create a pooled root sample, live roots within the same **Size Category** are pooled across the *'North'* and *'South'* samples that originate from the same **Clip Cell Number**.
  - b. The Belowground Biomass Grind and Pool app employs the logic in **Table 11** to determine which pooled samples should be created.
  - c. The pooled sample is created, ground, and split into representative subsamples.
  - d. A maximum of 4 pooled root samples are created and ground per unique **Clip Cell Number** (one for each **Size Category**).
3. **Mandatory barcode workflow:** Sample containers shipped for external analysis or archive must have barcodes in addition to human-readable information on each container.
  - a. Barcodes are required by the [Stork Shipping Tool](#), and enable automatic creation of shipping manifests, as well as receipt and tracking forms for all relevant parties.
    - *Note:* Stork is only accessible from computers on the internal NEON network.
  - b. Apply barcodes to vials a minimum of 30 minutes before vials are used (*see SOP A*).
  - c. Barcodes on sample containers are linked to upstream root and soil collection information via the Belowground Biomass Grind and Pool app.

### Procedural steps:

1. Use the Belowground Biomass Grind and Pool app to determine, based on the total mass of each **pooled** live root sample, which processing steps are required (see **Table 11**).
  - a. Create a parent-level record in the Grind and Pool app corresponding to each soil Sample ID collected in the field.
  - b. Select the **Domain ID**, **Site ID** and **Sample ID List** using information written on the coin envelope, OR
    - i. **Optional Barcode Workflow:** Scan the barcode affixed to a dried root subsample envelope to bring up the Domain, Site, and list of samples available

|   |                  |                 |
|---|------------------|-----------------|
| Title: TOS Protocol and Procedure: Plant Belowground Biomass Sampling |                  | Date: 01/22/219 |
| NEON Doc. #: NEON.DOC.014038  | Author: C. Meier | Revision: G     |

for pooling. If > 1 envelopes are barcoded, any envelope from the same soil sample may be scanned.

- c. Create and save a child-level record for each **Size Category**.
- d. The app displays the CN Sample ID and the BGC Archive ID fields, when sufficient sample is available according to the logic in **Table 11**.
- e. Save the parent record.

**Table 11.** Splitting and processing guidelines for fine root samples, based on pooled sample mass.

| dryMass      | Samples to create |                | Processing guidelines  |
|--------------|-------------------|----------------|--|
|              | C:N sample        | Archive sample |  |
| <0.02 g      | -                 | -              | Do not process sample for C:N analysis or archive.   |
| 0.02 – 0.4 g | X                 |                | Do not grind; place entire pooled sample in scint vial. Use gloved hand to crush if necessary.   |
| 0.4 – 1 g    | X                 |                | Grind entire sample to 40 mesh for C:N analysis  |
| > 1 g        | X                 | X              | Grind entire sample to 20 mesh; use splitter to generate a 0.4 g subsample that is ground to 40 mesh for C:N analysis; archive remainder of 20 mesh grind. |

2. Once records have been created for all samples:
  - a. Filter and download the data for the records that match the samples, and
  - b. Use a return-address template to print **CN Sample ID** and **BGC Archive ID** labels for those pooled root samples that have sufficient mass to warrant processing.
  - c. Label vials for shipment to external analysis, and possibly, archive. Orient labels vertically so the label does not overlap the mandatory barcode.
    - i. For vials that may contain tissue from *Toxicodendron spp.*: Use vials with a warning sticker prepared in SOP A.3.
  - d. **Optional Barcode Workflow:** Retain a barcode affixed to an envelope for each group of root samples from the same soil sample, and keep with the associated vials. The barcode will be subsequently used to more rapidly link vial barcodes with the correct Grinding and Pooling records.
3. For root samples that may contain tissue from *Toxicodendron spp.*: Do NOT grind and split as per standard samples. Subsample for chemical analysis and archive according to steps (a) – (g) below, and skip steps (4) and (5).



|   |                  |                 |
|---|------------------|-----------------|
| Title: TOS Protocol and Procedure: Plant Belowground Biomass Sampling |                  | Date: 01/22/219 |
| NEON Doc. #: NEON.DOC.014038  | Author: C. Meier | Revision: G     |



- a. Use caution when handling the sample so as to avoid exposure to tissue containing toxic oils. Wear single-use cotton gloves as described in RD[12] and follow the guidelines in RD[12] to clean any equipment, clothing, or skin that comes in contact with such tissue.
  - b. Conduct all subsampling activities in a clean fume hood to contain dust particles.
  - c. Homogenize the sample by cutting roots into approximately 1 cm length fragments using scissors.
    - i. The sample may be transferred from the envelope to an appropriately sized metal or plastic weigh pan to facilitate homogenizing.
    - ii. Clean the weigh pan with a tissue between samples and re-use.
  - d. Manually split the homogenized root material into two subsamples according to the logic in **Table 11**.
    - i. Try to ensure the splits are representative, and
    - ii. Handle with forceps to prevent unnecessary contact.
  - e. Place unground chemistry and archive subsamples into labeled, barcoded 20 mL scintillation vials.
  - f. Clean all durable supplies and surfaces that may have come into contact with sample material as described in RD[12].
  - g. Continue to steps (6) and (7).
4. Prepare roots for sampling. It is important that large diameter roots and long lengths of root are not introduced into the grinding chamber.
    - a. For roots samples with diameter  $\leq 0.5$  mm: No preparation is necessary.
    - b. For root samples with  $0.5$  mm < diameter  $\leq 2$  mm: Cut into approximately 1 cm fragments.
    - c. For root samples > 2 mm diameter:
      - i. Cut into 1 cm fragments
      - ii. Manually break-up with a clean mortar and pestle to prevent introducing large-diameter woody root pieces into the grinding chamber.
      - iii. Clean the mortar and pestle with ethanol and a kim-wipe between samples.
  5. Grind and split oven-dried pooled root samples according to the logic in **Table 11**, and place splits into the appropriately labeled 20 mL vials.
    - a. Do NOT load sample into the mill while it is powered off.

|   |                  |                 |
|---|------------------|-----------------|
| Title: TOS Protocol and Procedure: Plant Belowground Biomass Sampling |                  | Date: 01/22/219 |
| NEON Doc. #: NEON.DOC.014038  | Author: C. Meier | Revision: G     |

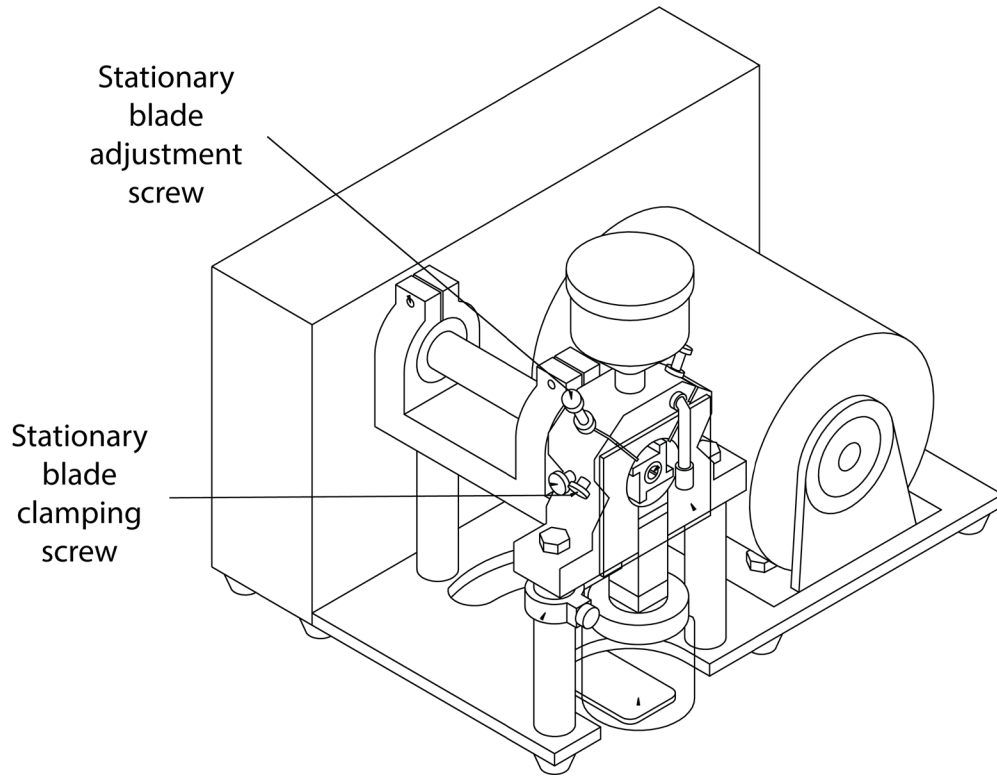
- b. Funnel root fragments into the grinding chamber at a measured rate. Material should not be funneled into the grinding chamber faster than ground material leaves the chamber.
  - c. Use an appropriately sized splitter or microsplits to generate representative sample splits. *DO NOT create splits with a scoopula or a spatula; these tools should only be used to transfer an ENTIRE split into a vial.*
  - d. Create a full vial for archive if possible. If a split is too large to fit into a vial in its entirety, continue splitting until the desired volume is obtained.
  - e. Clean grinding tools and splitter thoroughly between samples:
    - i. For a grinding mill: Power off, unplug, remove protective glass, and clean grinding chamber with compressed air. Clean glass with a kimwipe and ethanol.
    - ii. Clean mortar and pestle with a kimwipe and ethanol.
  - f. Once pooled samples have been ground and sealed into vials, excess ground biomass may be discarded.
6. **Mandatory Barcode Workflow:** Link vial barcodes with Grinding and Pooling records previously created in step (1).
- a. Filter and find the desired parent record for a given group of vials from the same soil sample.
    - i. **Optional Barcode Workflow:** Scan the root envelope barcode associated with a group of vials to bring up the desired parent record.
  - b. Open and edit each child-level record, and scan in the required **CN Sample Barcode**, and if sufficient sample was present, the required **BGC Archive Barcode**.
  - c. Save each child record.
  - d. Save the parent record.
7. See **SOP E** for shipping instructions.
- a. Store samples in a cool, dry location until they can be shipped to analytical facilities or biorepository.

|   |                  |                 |
|---|------------------|-----------------|
| Title: TOS Protocol and Procedure: Plant Belowground Biomass Sampling |                  | Date: 01/22/219 |
| NEON Doc. #: NEON.DOC.014038  | Author: C. Meier | Revision: G     |

**C.5 Equipment maintenance**

1. Balances should be calibrated with a standard calibration weight set:
  - a. After initial installation.
  - b. Any time the balance is moved to a new surface.
  - c. Every 6 months.
  - d. If you suspect readings are inaccurate for any reason.
  
2. The Wiley Mini Mill
  - a. Check stationary blades: Stationary blades may move during the course of processing large-diameter roots and require adjustment.
    - i. Check for tip-to-tip clearance between all rotor blades and stationary blades by placing a piece of paper with average thickness against each stationary knife in turn.
    - ii. Turn the rotor shaft by hand counter-clockwise so that all four rotor blades pass the stationary blade.
    - iii. Blades should touch the paper but not cut it.
  - b. Adjust stationary blades if warranted based on check above (**Figure 14**).
    - i. Loosen stationary blade clamping screw.
    - ii. Tighten stationary blade adjustment screw so that stationary blade is moved closer to rotor blades.
    - iii. Tighten stationary blade clamping screw.
    - iv. Repeat for other stationary blade.
    - v. Perform stationary blade check above in 2.a . Stationary blades **MUST NOT TOUCH ROTOR BLADES DURING OPERATION. SEVERE DAMAGE WILL RESULT.**
  - c. Blade sharpening or replacement
    - i. Blade sharpening or replacement may be required if adjusting the position of stationary blades does not improve mill performance.
    - ii. Contact Troemner for an RMA at 1-800-352-7705 and select option for Technical Service.
    - iii. Order the online [Sharpening Service](#) from Thomas Scientific.
    - iv. Allow 4 weeks for service to be completed.

|   |                  |                 |
|---|------------------|-----------------|
| Title: TOS Protocol and Procedure: Plant Belowground Biomass Sampling |                  | Date: 01/22/219 |
| NEON Doc. #: NEON.DOC.014038  | Author: C. Meier | Revision: G     |



**Figure 14.** Wiley Mini Mill diagram showing position of stationary blade adjustment and clamping screws.

|   |                  |                 |
|---|------------------|-----------------|
| Title: TOS Protocol and Procedure: Plant Belowground Biomass Sampling |                  | Date: 01/22/219 |
| NEON Doc. #: NEON.DOC.014038  | Author: C. Meier | Revision: G     |

## SOP D Dilution Sampling for Fine Root Fragments

### Goals

- Quantify the ratio of root fragments < 1 cm length to organic material in the residual fraction for selected soil samples.
- Collect required dilution sampling data:
  - The preferred method for data collection is the Belowground Biomass Lab Dilution application.
  - The Belowground Biomass Sampling Fulcrum Manual on the SSL contains detailed data entry instructions.

### Overview

1. **When samples are processed:** Dilution sampling for quantifying fine root fragments < 1 cm length begins after a soil sample has been sieved and all roots ≥ 1 cm length have been picked from the residual fraction (see SOP C.1).
  - It is acceptable to pause overnight between execution of SOP A and 0.
  - Store labeled residual fractions overnight at 4 °C in a sealed container (e.g., labeled 50 mL tube).
2. **Which samples are processed:** Fine root fragments are quantified each time the fine root biomass protocol is implemented by dilution sampling. Twenty (20) soil samples are selected for dilution sampling in a spatially balanced manner. The goal is to select soil samples such that as much of the tower airshed area as possible is represented by the final dilution sample set.

If fewer than 20 Tower Plots are established at a site, the number of soil samples selected for dilution sampling equals the number of Tower Plots. **Modify the decision tree below accordingly.**

To determine which samples are selected:

- a. Were greater than 20 soil samples collected in total from all plots?
  - i. If **YES**, proceed to (b).
  - ii. If **NO**, generate a dilution sample from each soil sample.
- b. Was a soil sample collected from each plot?
  - i. If **YES** and there are thirty 20m x 20m short-stature vegetation plots (**Figure 1, left**): Randomly select 1 sample per plot from the plots with the 20 lowest Morton Order numbers.
  - ii. If **YES** and there are twenty 40m x 40m tall-stature vegetation plots (**Figure 1, right**): Randomly select 1 sample per plot.
  - iii. If **NO**, soil samples were not collected from each plot:



|   |                  |                 |
|---|------------------|-----------------|
| Title: TOS Protocol and Procedure: Plant Belowground Biomass Sampling |                  | Date: 01/22/219 |
| NEON Doc. #: NEON.DOC.014038  | Author: C. Meier | Revision: G     |

1. Proceed to (c) for 20m x 20m short-stature plots
  2. Proceed to (d) for 40m x 40m tall-stature plots.
- c. Was a soil sample collected from 20 plots or more?
- i. If **YES**: For those plots with **Root Sampling Possible** = 'Yes', randomly select 1 sample per plot from the plots with the 20 lowest Morton Order numbers.
  - ii. If **NO**, soil samples were collected from < 20 plots:
    1. For those plots with **Root Sampling Possible** = 'Yes', randomly select 1 sample per plot.
    2. Select additional samples from the remaining pool according to Morton Order (lowest to highest) until a total sample size of 20 is reached.
- d. For those 40m x 40m plots with **Root Sampling Possible** = 'Yes', was a soil sample collected from both 20m x 20m subplots in each plot?
- i. If **YES**, samples were collected from both 20m x 20m subplots per plot:
    1. Randomly select one 20m x 20m subplot per plot. If both North and South samples were collected from the chosen subplot, randomly select 1 soil sample (North or South). Total dilution sample size is < 20 at this point.
    2. Select additional dilution samples by plot according to Morton Order (lowest to highest). This time, select a soil sample from the 20m x 20m subplot that was NOT randomly selected in (1) immediately above. If both North and South samples were collected from the chosen subplot, randomly select 1 soil sample (North or South).
    3. Continue down the Morton Order list until 20 dilution samples have been selected.
  - ii. If **NO**, samples were not collected from both 20m x 20m subplots in each plot: proceed to (e).
- e. For those 40m x 40m plots with **Root Sampling Possible** = 'Yes', and for at least one plot a soil sample was collected from only one 20m x 20m subplot:
- i. For all plots in which only one subplot generated a sample: If both North and South soil samples were collected, randomly select 1 soil sample per plot for dilution sampling.
  - ii. For all plots in which two subplots generated a sample:

|   |                  |                 |
|---|------------------|-----------------|
| Title: TOS Protocol and Procedure: Plant Belowground Biomass Sampling |                  | Date: 01/22/219 |
| NEON Doc. #: NEON.DOC.014038  | Author: C. Meier | Revision: G     |

1. Randomly select one 20m x 20m subplot per plot. If both North and South samples were collected from the chosen subplot, randomly select 1 soil sample (North or South). Total dilution sample size is < 20 at this point.
2. Randomly select additional dilution samples from 20m x 20m subplots that were NOT initially chosen in (1) immediately above. If both North and South samples were collected, randomly select 1 soil sample (North or South).
- iii. If a dilution sample size of 20 still is not met, randomly select additional samples from the remaining pool until 20 total samples are selected.

3. **How samples are processed:**

- a. The entire residual fraction *containing all root fragments < 1 cm length from the soil sample* is suspended in water and vortexed to homogenize, creating a **Dilution Sample**.
- b. **Dilution Subsamples** (n=10) are extracted from the vortexing **Dilution Sample**.
- c. **Dilution Subsamples** are sorted to root and soil organic matter components, and then dried and weighed to enable calculation of total root fragment mass in the residual fraction.



- i. **Masses must be recorded to minimum 0.001 g accuracy; 0.0001 g accuracy is preferred.**

- d. **Sample Volume** and **Aliquot Volume** are optimized on a per soil type basis to generate root fragment and soil organic material masses that are sufficiently large such that reliable masses can be weighed, but that are not so large that sorting to completion requires more than an average of 15 min per Dilution Subsample.

4. **Digital workflow:**

- a. Records in the Belowground Biomass Lab Dilution app are created for dilution samples in SOP C.1.
- b. **Pre-oven dry:** Previously created records are edited to create child-level records containing Dilution Subsample IDs. The Tin ID is added for each child record and the record is saved.
- c. **Post-oven dry:** Each child record is edited to add **Dry Mass** and the record is saved.

|   |                  |                 |
|---|------------------|-----------------|
| Title: TOS Protocol and Procedure: Plant Belowground Biomass Sampling |                  | Date: 01/22/219 |
| NEON Doc. #: NEON.DOC.014038  | Author: C. Meier | Revision: G     |

### ***Dilution Sampling Steps***

For selected residual fraction samples, the steps below describe how to separate root fragments from soil organic matter and quantify root fragment biomass with a relatively time-efficient technique.

1. Take the residual fraction from SOP A, transfer to a clean 250 µm sieve, and carefully wash with the root washer nozzle. The residual fraction should be free from mineral soil particles at this point.
2. Transfer the consolidated residual fraction to a beaker – i.e. all roots < 1 cm length from a given soil sample – and suspend the sample in water. **Use distilled water** from this point forward, including water used to rinse the sieve that is then collected. Mineral build-up on weighing tins has been shown to significantly alter perceived root and organic matter masses.
  - a. Based on the size of the residual fraction, choose either a 1 L, 2 L, or 4 L beaker. Note that the size of the beaker can be varied from core to core, depending on the size of the residual fraction.



**TIP:** The goal is to sufficiently dilute the residual fraction so that not too many roots need to be picked and sorted, but not dilute so much that there are too few roots to weigh accurately once they are dry. If in doubt, use the 1 L beaker, and dilute further if necessary.

- b. Manually transfer as much of the residual fraction as possible to the beaker. Use a scoopula, spatula or equivalent.
- c. Transfer any remaining residual fraction from the 250 µm sieve to the beaker; use a squirt bottle and ≤ 500 mL of water to rinse the sieve.
- d. Carefully fill the beaker with distilled water to approximately ¾ full (e.g., 750 mL, 1.5 L, or 3 L). Add water to the sample to bring up to the target volume. It is helpful to fill to one of the pre-marked graduations on the beaker, as an accurate volume at this step will be used to estimate the total mass of root fragments < 1 cm length.

*In the steps that follow, when data entry is required, data may be entered directly into the digital workflow by editing an existing record, or may be recorded on paper for multiple samples, then transcribed.*

3. Record required **Dilution Sample** metadata.
  - **Sample Volume;** total volume of water + residual fraction in the beaker; best precision possible, e.g., nearest 10 mL
  - **Processed Date;** date dilution sampling is carried out, YYYYMMDD format.
  - **Dilution Sample Fate;** set to ‘lost’ if equipment breakage occurs during subsequent steps and sample is compromised.

|   |                  |                 |
|---|------------------|-----------------|
| Title: TOS Protocol and Procedure: Plant Belowground Biomass Sampling |                  | Date: 01/22/219 |
| NEON Doc. #: NEON.DOC.014038  | Author: C. Meier | Revision: G     |

4. Label 10 pairs (n=20 total) of aluminum weighing tins to hold the 10 Dilution Subsamples.
  - Tins should be pre-numbered with a unique **Tin ID** (e.g. 1, 2, 3,..., 20, etc.)(see **Figure 16**). The **Tin ID** is tracked with the sample, rather than labeling each tin with sample information.
  - For each pair of tins, one is for root fragments, and the other is for organic material.
5. Pre-weigh each empty, dry tin with a microbalance; nearest 0.001 g (minimum), or nearest 0.0001 g (preferred).
  - a. Tins should be oven-dried at 65 °C for 15-30 min prior to weighing to remove adsorbed moisture (use whichever temperature is most convenient based on existing oven temperatures). The microbalance will detect moisture adsorbed from the air in humid environments.
  - b. Tins must return to room temperature before weighing. Store in a desiccator between drying and weighing to ensure moisture does not re-adsorb to the surface while cooling.
  - c. Associate tin data with previously created Lab Dilution records:
    - **Tin ID**; the unique number assigned to the tin.
    - **Empty Tin Mass**; the mass of the clean, dry, empty tin.
    - (Paper workflow) **Dilution Subsample Number**; 1-10, technician assigned, needed to track pairs of tins from the same Dilution Subsample (**Figure 16**).
6. Work in pairs to generate 10 **Dilution Subsamples** from the aqueous suspended **Dilution Sample** in the beaker (**Figure 15**). Consult the training video for a visual demonstration of the following steps:
  - a. [Person1] Turn the plate mixer on high, and vortex the aqueous suspended Dilution Sample thoroughly (approx. 10 s from the start of vortexing).
  - b. [Person1] Turn off the mixer, and quickly plunge the suspension to stop the vortex and randomize the sample in the water.
  - c. [Person2] Take a 20 mL Dilution Subsample from the middle of the water volume in the beaker using the customized syringe, and transfer to one of the 'OM' tins.
    - i. Take care to keep the syringe vertical during transfer. Tilting the syringe may allow air to enter the aperture and sample will spill out.

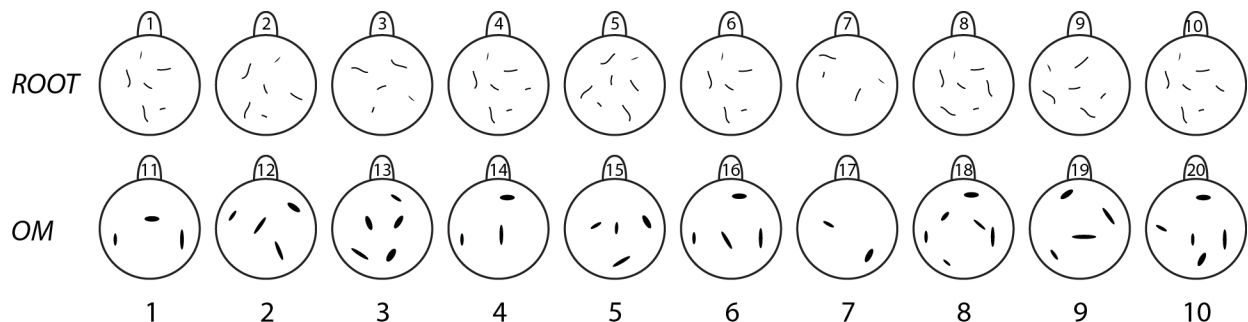
**NOTE:** In addition to adjusting the beaker **Sample Volume** in step (3) above, the Dilution Subsample **Aliquot Volume** obtained with the syringe can also be adjusted from 20 mL to optimize the amount of material needed for sorting and weighing. For example, collect 10 mL if the suspension is particularly dense.
  - d. [Person2] Back off the plunger in the syringe to the 5 mL mark. Rinse the interior of the syringe with the squirt bottle, and transfer the rinse to the same tin.

|   |                  |                 |
|---|------------------|-----------------|
| Title: TOS Protocol and Procedure: Plant Belowground Biomass Sampling |                  | Date: 01/22/219 |
| NEON Doc. #: NEON.DOC.014038  | Author: C. Meier | Revision: G     |



**Figure 15.** Example of sorting fine root fragments from a dilution subsample (*left*) into a clean ‘root’ tin (*right*). The amount of material in the left tin is a good target when creating dilution subsamples.

7. Record required Dilution Subsampling metadata:
  - **Aliquot Volume**; the volume of the subsample taken with the syringe; nearest 1 mL.
    - The volume of water from the squirt bottle should not be added to this number.
  - (Paper workflow) **Subsample Type**; the type of material the tin will hold after picking and sorting is complete; the tin initially receiving the mixed sub-sample should be **Subsample Type = ‘OM’**, and the tin into which roots are sorted should be **Subsample Type = ‘ROOT.’** Repeat steps (5) and (6) until 10 sub-samples have been transferred to 10 ‘OM’ tins (**Figure 16**).
8. For each of the 10 Dilution Subsamples, carefully pick and sort root fragments from organic material and transfer the roots to the ‘ROOT’ tin of the pair (**Figure 16**; see Section 2.4 for ‘organic material’ definition).
  - A small amount of water in the ‘ROOT’ tin aids in transferring root material.
  - **Aim for no more than 15 min sorting time per tin pair, 10-15 min is ideal**; adjust the **Sample Volume** in the beaker and the **Aliquot Volume** in the syringe as necessary.



**Figure 16.** Ten pairs of labeled aluminum weighing tins for separating roots from OM. Dilution Subsamples are initially transferred to the *OM* tins via syringe, and roots are then sorted into the *ROOT* tins. Each tin has a unique Tin ID.

|   |                  |                 |
|---|------------------|-----------------|
| Title: TOS Protocol and Procedure: Plant Belowground Biomass Sampling |                  | Date: 01/22/219 |
| NEON Doc. #: NEON.DOC.014038  | Author: C. Meier | Revision: G     |

9. Carefully transfer tins to a 65 °C drying oven for 48 h. Record:

- **Oven Start Date/Time;** the date and time the samples were placed in the drying oven.

Tips:

- Use a tray to move batches of tins in the laboratory.
- Heavy duty metal trays may be placed directly in the drying oven with all of the samples.
- Do not leave samples on light-weight trays in the drying oven. Light-weight metal trays occasionally twist when heated which will cause samples to spill.
- Place a large piece of cardboard over tins to prevent oven fans from blowing very light dried samples out of the tins.

10. Repeat steps (2) – (9) for additional soil samples.

11. Once tins are dry, weigh the total mass of each ‘tin+ROOT’ or ‘tin+OM’ with a microbalance (0.0001 g precision preferred, 0.001 g precision acceptable).

- Tins must return to room temperature prior to weighing.
  - Place tins in a desiccator to cool to room temperature. Warm tins create air currents within the microbalance enclosure that affect perceived mass.
  - If it takes longer than 2-3 minutes for the tin + sample to return to room temperature before weighing, place tins in a desiccator to cool, then weigh.
- Weigh one at a time from desiccator, and record required ‘Lab Dilution’ data:
  - Oven End Date/Time;** the date and time samples were removed from the drying oven.
  - Dry Mass;** the mass of the dry ‘tin+ROOT’ or ‘tin+OM’ material; nearest 0.001 g (minimum), nearest 0.0001 g (preferred).

|   |                  |                 |
|---|------------------|-----------------|
| Title: TOS Protocol and Procedure: Plant Belowground Biomass Sampling |                  | Date: 01/22/219 |
| NEON Doc. #: NEON.DOC.014038  | Author: C. Meier | Revision: G     |

## SOP E Data Entry and Verification

Mobile applications are the preferred mechanism for data entry. Data should be entered into the protocol-specific application as they are being collected, whenever possible, to minimize data transcription and improve data quality. For detailed instructions on protocol-specific data entry into mobile devices, see the internal NEON Sampling Support Library ([SSL](#)). Mobile devices should be synced at the end of each field day, where possible; alternatively, devices should be synced immediately upon return to the Domain Support Facility.

However, given the potential for mobile devices to fail under field conditions, it is imperative that paper datasheets are always available to record data. Paper datasheets should be carried along with the mobile devices to sampling locations at all times. As a best practice, field data collected on paper datasheets should be digitally transcribed within 7 days of collection or the end of a sampling bout (where applicable). However, given logistical constraints, the maximum timeline for entering data is within 14 days of collection or the end of a sampling bout (where applicable). See RD[04] for complete instructions regarding manual data transcription.

### E.1 Digital Data Workflow

#### Data collected in the field:

1. The **Clip ID**, **Collect Date** and sampling area (North/South) are used to construct the soil **Sample ID**. Make sure these data are entered correctly before finalizing Field records.
2. Finalizing Field records and syncing will make **Sample IDs** available for further data entry in the Lab Weighing, Lab Dilution, and Grinding and Pooling applications.
  - a. If corrections to either the Clip ID, Collect Date, or sampling area are required after a Sample ID has been selected in a downstream application:
    - i. Make correction(s) in the Belowground Biomass Field app and save.
    - ii. Open, edit, and save each downstream parent and child record in order to propagate the update.
  - b. Consult the plant Belowground Biomass Sampling Fulcrum User Manual on the SSL for more detail.

#### Lab Weighing and Grinding and Pooling:

1. The **Sample ID**, **Size Category** and **Root Status** information are used to construct the **Subsample ID** that is associated with a given Dry Mass value.
2. The downstream Grinding and Pooling application uses masses from available Subsample IDs to determine which subsamples are pooled, processed and shipped to external facilities.
  - a. If corrections to data used to construct Subsample IDs are required:
    - i. Make correction(s) in the Belowground Biomass Lab Weighing app and save.

|   |                  |                 |
|---|------------------|-----------------|
| Title: TOS Protocol and Procedure: Plant Belowground Biomass Sampling |                  | Date: 01/22/219 |
| NEON Doc. #: NEON.DOC.014038  | Author: C. Meier | Revision: G     |

- ii. Open, edit, and save each downstream parent and child record in order to propagate the update.

**Lab Dilution data:**

1. The **Sample ID** from the Field application is used to construct the **Dilution Sample ID**.
2. If corrections to either the Clip ID, Collect Date, or sampling area are required in the Field app after a Sample ID has been selected in the Lab Dilution app:
  - a. Make correction(s) in the Belowground Biomass Field app and save.
  - b. Open, edit, and save each Lab Dilution parent and child record in order to propagate the update.

See the Data Management Protocol (RD[04]) for detailed, protocol-specific Data Management SOPs. See training materials on the SSL for detailed data ingest guidance via the NEON digital workflow.

**E.2 Field Datasheets**

1. Transcribe data from the plant Belowground Biomass Field Datasheets (RD[05]) to the Field application.
  - Consult the Belowground Biomass Fulcrum Manual on the SSL to determine appropriate values and formats for each field in the ingest table.
2. If a representative clip cell did not support belowground biomass soil sampling, noted as 'Root Sampling Possible = N' in the **remarks** field of the Field Datasheet, enter in the Field ingest:
  - **Root Sampling Possible = 'No'**
3. Update permanent digital versions of the Clip Lists with **date** and **status = '5'** data recorded in the field.

**E.3 Lab Datasheets**

- Transcribe data from the 'Lab Weighing' datasheet into the 'Lab Weighing' application.
  - If a core sample contained no fine root biomass within a given **Size Category**, select 'No' in the appropriate sample Presence/Absence field.
- Transcribe data from the 'Lab Dilution' datasheet into the 'Lab Dilution' application.



|   |                  |                 |
|---|------------------|-----------------|
| Title: TOS Protocol and Procedure: Plant Belowground Biomass Sampling |                  | Date: 01/22/219 |
| NEON Doc. #: NEON.DOC.014038  | Author: C. Meier | Revision: G     |

## SOP F Sample Shipment

Information included in this SOP conveys science-based packaging, shipping, and handling requirements for these samples, not lab-specific or logistical demands. For lab-specific shipping information, reference the “Shipping Information for External Facilities” document on [CLA’s NEON intranet site](#).

- **Timelines:** Dried, root samples may be stored indefinitely before shipping.
- **Storage/Shipping Conditions:** Dried root samples sealed in 20 mL plastic or glass vials may be shipped at ambient temperature without preservatives.
- **Grouping/Splitting Samples:** Samples originating from the same clip cell should be grouped together for shipment, if possible.
- **Samples Containing *Toxicodendron*:** Samples that contain or may contain tissue from *Toxicodendron spp.* require labeling to ensure the receiving lab is aware of the contents.



- Label 20 mL scint vials that may contain *Toxicodendron* tissue with a warning sticker affixed to the lid.
- Use the ‘Shipment Remarks’ field in the Shipping App to indicate “***X samples in the shipment contain Toxicodendron, handle with care.***”

### F.1 Shipment Preparation Procedure

1. Take scintillation vial box containing processed samples out of temporary storage for shipment.
2. Wrap the box in bubble wrap and tape securely, then place in a FedEx box for shipment.
3. Navigate to the “Shipping Information for External Facilities” document on CLA’s NEON intranet site.
  - Determine which additional documentation is required to accompany the shipment (e.g., USDA permits and/or cover letters).
  - Check the intranet instructions frequently, *as shipping instructions are subject to change.*
4. Print out required documents (if needed), and include in the shipment box.
5. Prepare a shipping inventory detailing the contents of the shipment, using the appropriate shipping applications. These include:
  - Shipping: Shipment Creation
  - Shipping: Shipment Review
  - [Stork Shipment Verification Tool](#)
6. Include a printed copy of the inventory in the shipment box.
7. Address shipping label appropriately, and ship ground.
8. Send an electronic copy of the shipping inventory to the email addresses listed in the “Shipping Information for External Facilities” document. Include the shipment Tracking Number in the email.

|   |                  |                 |
|---|------------------|-----------------|
| Title: TOS Protocol and Procedure: Plant Belowground Biomass Sampling |                  | Date: 01/22/219 |
| NEON Doc. #: NEON.DOC.014038  | Author: C. Meier | Revision: G     |

## F.2 Laboratory Contact Information and Shipping / Receipt Days

See the “Shipping Information for External Facilities” and “External Facilities Closure Dates” documents on [CLA’s NEON intranet site](#).

## 8 REFERENCES

- Berhongaray, G., J. S. King, I. A. Janssens, and R. Ceulemans. 2013. An optimized fine root sampling methodology balancing accuracy and time investment. *Plant and Soil* **366**:351-361.
- Burton, A. J., and K. S. Pregitzer. 2008. Measuring forest floor, mineral soil, and root carbon stocks. Pages 129-142 *in* C. M. Hoover, editor. *Field measurements for forest carbon monitoring*. Springer-Verlag, New York.
- Didan, K. 2015. MOD13Q1 MODIS/Terra Vegetation Indices 16-Day L3 Global 250m SIN Grid V006. NASA EOSDIS Land Processes DAAC. <https://doi.org/10.5067/MODIS/MOD13Q1.006>.
- Koteen, L., and D. Baldocchi. 2013. A randomization method for efficiently and accurately processing fine roots, and separating them from debris, in the laboratory. *Plant and Soil* **363**:383-398.
- Milchunas, D. G., and W. K. Lauenroth. 2001. Belowground primary production by carbon isotope decay and longterm root biomass dynamics. *Ecosystems* **4**:139-150.
- Steinaker, D. F., and S. D. Wilson. 2005. Belowground litter contributions to nitrogen cycling at a northern grassland-forest boundary. *Ecology* **86**:2825-2833.
- Taylor, B. N., K. V. Beidler, E. R. Cooper, A. E. Strand, and S. G. Pritchard. 2013. Sampling volume in root studies: the pitfalls of under-sampling exposed using accumulation curves. *Ecology Letters* **16**:862-869.
- Tierney, G. L., and T. J. Fahey. 2007. Estimating belowground primary productivity. Pages 120-141 *in* T. J. Fahey and A. K. Knapp, editors. *Principles and standards for measuring primary production*. Oxford University Press, New York.

|  |                         |                        |
|--|-------------------------|------------------------|
| <i>Title:</i> TOS Protocol and Procedure: Plant Belowground Biomass Sampling |                         | <i>Date:</i> 01/22/219 |
| <i>NEON Doc. #:</i> NEON.DOC.014038  | <i>Author:</i> C. Meier | <i>Revision:</i> G     |

**APPENDIX A DATASHEETS**

The following datasheets are associated with this protocol:

**Table 12.** Datasheets associated with this protocol

| <b>NEON Doc. #</b> | <b>Title</b>  |
|--------------------|---|
| NEON.DOC.002135    | Datasheets for TOS Protocol and Procedure: Plant Belowground Biomass Sampling |
|                    |   |

These datasheets can be found in Agile or the NEON Document Warehouse.

|   |                  |                 |
|---|------------------|-----------------|
| Title: TOS Protocol and Procedure: Plant Belowground Biomass Sampling |                  | Date: 01/22/219 |
| NEON Doc. #: NEON.DOC.014038  | Author: C. Meier | Revision: G     |

**APPENDIX B SAMPLING QC CHECKLIST**

**B.1 Collecting Soil Samples in the Field**

1. Select the first available cell from the Clip List, and assess for suitability. Be sure to check if Herbaceous Biomass sampling has already occurred in the current season, and if a cell has already been clipped, choose the clipped cell to co-locate sampling.
2. Collect one sample from the North sampling area, and another sample from the South sampling area.
3. Measure and record the depth of the sample hole.
4. Create a label for each soil sample on waterproof paper, and be sure to record all required sampling metadata.
5. Record the date and time the soil sample was placed in the cooler in the field.

|   |
|---|
| <p><b>QUALITY DEPENDS ON PROPER:</b></p> <ul style="list-style-type: none"> <li>• Labeling of soil samples.</li> <li>• Measurement of sample hole depth.</li> <li>• Maintaining samples in cold storage.</li> </ul> |
|---|

***Improper or inconsistent labeling is a common and problematic error associated with this work!***

**B.2 Processing Belowground Biomass Samples in the Laboratory**

1. Figure out ahead of time which 20 samples will be randomly selected for Dilution Sampling.
2. Soak samples prior to sieving in a plastic bin or bucket.
3. Process one small aliquot of the sample slurry through the sieve stack at a time – ***avoid overflowing the fine bottom sieve!***
4. Use a wire gauge to determine root **sizeCategory** – ***always measure root diameter through the gap in side of the wire gauge.*** Do NOT pass the root through the hole of the gauge.
5. Sort roots by **sizeCategory** and **rootStatus**.
6. Dry sorted roots for a minimum of 48 h at 65 °C.

|  |
|--|
| <p><b>QUALITY DEPENDS ON PROPER:</b></p> <ul style="list-style-type: none"> <li>• Passing the samples through the sieves – DO NOT OVERFLOW!</li> <li>• Removal of mineral soil and organic material from roots.</li> <li>• Use of the wire gauge for <b>sizeCategory</b> sorting.</li> </ul> |
|--|

|   |                  |                 |
|---|------------------|-----------------|
| Title: TOS Protocol and Procedure: Plant Belowground Biomass Sampling |                  | Date: 01/22/219 |
| NEON Doc. #: NEON.DOC.014038  | Author: C. Meier | Revision: G     |

### B.3 Dilution Sampling for Fine Root Fragments

1. Retain the residual fraction from randomly selected soil samples for Dilution Sampling.
2. Label all sample tins to ensure that samples can be tracked.
3. Work in pairs to quickly obtain representative subsamples of the suspended residual fraction.
4. Adjust the size of the beaker (**sampleVolume**) and the size of the sub-sample (**subSampleVolume**) to keep sorting time manageable.
  - a. Use distilled or filtered water.
  - b. Aim for approximately 10-15 minutes per tin pair.
5. Dry sorted root fragments and OM for a minimum of 48 h at 65 °C.
6. Use a desiccator to cool samples before weighing them.

#### QUALITY DEPENDS ON:

- Choosing an appropriately sized beaker for suspending the residual fraction. Too concentrated will take too long to sort, and too dilute will result in masses too light to accurately weigh.
- Dispersing the residual fraction evenly throughout the sample volume in the beaker to generate representative subsamples.
- Accurately distinguishing roots from organic material.

|   |                  |                 |
|---|------------------|-----------------|
| Title: TOS Protocol and Procedure: Plant Belowground Biomass Sampling |                  | Date: 01/22/219 |
| NEON Doc. #: NEON.DOC.014038  | Author: C. Meier | Revision: G     |

**APPENDIX C ESTIMATED DATES FOR ONSET AND CESSATION OF SAMPLING**

Soil sampling for plant Belowground Biomass is ideally timed to broadly coincide with the peak aboveground biomass clip harvest due to the scientific utility of relatively coincident estimates of both aboveground and belowground biomass. As such, dates listed in **Table 13** below are the estimated dates after which greenness begins to decrease at each site, and in theory, after which the majority of above and belowground biomass has been produced. Dates are averages of 2005-2014 MODIS-EVI satellite phenology data (Didan 2015). However, soil moisture also influences the timing of sampling, and as such, dates below may need to be adjusted at a given site based on soil moisture conditions within a given year. Soil core sampling should be concluded within 6 weeks of the actual start date.

**Table 13.** Estimated average dates after which greenness begins to decrease for each NEON site based on MODIS-EVI phenology data. Ideally, soil core sampling and aboveground biomass clip harvests should occur on or near these dates.

| Domain | Site | Start Date (MM/DD) | Additional Information   |
|--------|------|--------------------|--|
| 01     | BART | 07/17              | Date is earlier than indicated by MODIS due to understory consistently senescing before overstory.         |
|        | HARV | 07/17              | Date is earlier than indicated by MODIS due to understory consistently senescing before overstory.         |
| 02     | BLAN | 07/13              |  |
|        | SCBI | 08/03              |  |
|        | SERC | 08/09              |  |
| 03     | DSNY | 07/19              | Flooded plots are likely at this time; Field Science to choose consistent alternative sampling start date. |
|        | JERC | 08/10              |  |
|        | OSBS | 07/15              |  |
| 04     | GUAN | 10/15              | Start date based on precipitation data and targets middle of wet season.                                   |
|        | LAJA | 10/15              | Start date based on precipitation data and targets middle of wet season.                                   |
| 05     | STEI | 08/08              |  |
|        | TREE | 08/08              |  |
|        | UNDE | 08/08              |  |
| 06     | KONA | 07/31              |  |
|        | KONZ | 07/30              |  |
|        | UKFS | 07/28              |  |
| 07     | GRSM | 08/03              |  |
|        | MLBS | 08/08              |  |
|        | ORNL | 07/24              |  |

|   |                  |                 |
|---|------------------|-----------------|
| Title: TOS Protocol and Procedure: Plant Belowground Biomass Sampling |                  | Date: 01/22/219 |
| NEON Doc. #: NEON.DOC.014038  | Author: C. Meier | Revision: G     |

| Domain | Site | Start Date (MM/DD)          | Additional Information  |
|--------|------|-----------------------------|---|
| 08     | DELA | 07/17                       |   |
|        | LENO | 07/17                       |   |
|        | TALL | 07/14                       |   |
| 09     | DCFS | 07/28                       |   |
|        | NOGP | 07/21                       |   |
|        | WOOD | 08/02                       |   |
| 10     | CPER | 07/26                       | Soil may be too hard for coring at greenness decrease date; earlier start date timed to soil moisture may be advised (late spring). |
|        | RMNP | 08/02                       |   |
|        | STER | 2-4 wks before crop harvest | If plot is fallow with no cover crop, sample at peak green of surrounding vegetation.   |
| 11     | CLBJ | 06/13                       |   |
|        | OAES | 06/13                       |   |
| 12     | YELL | 07/12                       |   |
| 13     | MOAB | 09/17                       | MODIS-EVI data difficult to interpret; may be as early as 08/08   |
|        | NIWO | 08/10                       |   |
| 14     | JORN | 09/03                       |   |
|        | SRER | 09/07                       | MODIS-EVI data variable; may be as early as 08/23   |
| 15     | ONAQ | 06/15                       |   |
| 16     | ABBY | 07/23                       |   |
|        | WREF | 07/27                       |   |
| 17     | SJER | 04/06                       |   |
|        | SOAP | 07/08                       |   |
|        | TEAK | 07/27                       |   |
| 18     | BARR | 07/27                       |   |
|        | TOOL | 07/26                       |   |
| 19     | BONA | 07/26                       |   |
|        | DEJU | 07/27                       |   |
|        | HEAL | 07/28                       |   |
| 20     | PUUM | 05/21                       | Start date based on precipitation data and targets end of wet season for logistical reasons.  |

|   |                  |                 |
|---|------------------|-----------------|
| Title: TOS Protocol and Procedure: Plant Belowground Biomass Sampling |                  | Date: 01/22/219 |
| NEON Doc. #: NEON.DOC.014038  | Author: C. Meier | Revision: G     |

## APPENDIX D SITE-SPECIFIC MODIFICATIONS

**Table 14.** Summary of site-specific belowground biomass sampling modifications and supporting rationale.

| Domain | Site(s)                              | Modification Type                            | Modification   | Standard Rule   | Rationale for Change   |
|--------|--------------------------------------|--|--|---|--|
| D18/19 | BARR<br>TOOL<br>BONA<br>DEJU<br>HEAL | Clarification:<br>Definition of soil surface | Site-specific criteria to determine where the soil surface begins.                             | Soil surface and litter layer are differentiated by former lacking discernable plant parts. | Fibric plant structures persist into soil organic layer; roots grow into living moss layers.   |
| D19    | DEJU                                 | Collection method                            | Use core method to collect samples despite rock layer that prevents collecting to 30 cm depth. | Monolith method is used when rock prevents collecting to 30 cm depth.                       | Monolith method intended for large, discontinuous rocks. Continuous rock layer at ~25cm depth at DEJU cannot be avoided via monolith method. |

### D.1 D18/19 Site-specific Modifications

1. To determine where the soil surface begins, use the presence of roots, color and texture:
  - a. The presence of roots determines the position of the soil surface. This means we will begin collecting a soil sample at depths where the substrate may still be comprised of identifiable plant parts (live or dead).
  - b. When vascular plant roots are absent, identify the boundary between mostly live or mostly dead plant material, and call this boundary the top of the organic soil horizon.
    - i. Dead plant material may still appear fibric and very much like a discernable plant part at this boundary.
    - ii. Finding the boundary can be difficult because live plant material, roots, and dead plant material will often transition along a continuum from the surface downward.
    - iii. To sample consistently, use color (green to brown), texture (soft and friable material should be mostly dead), and presence of roots.

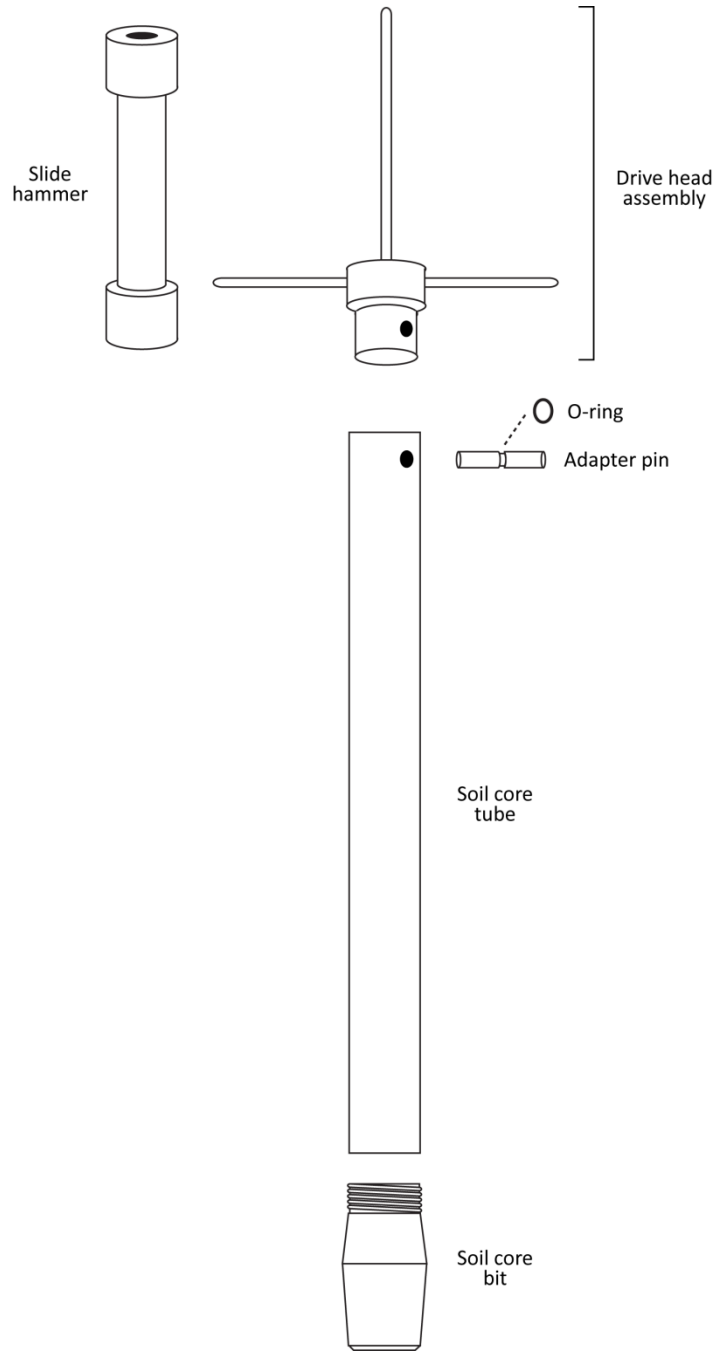


|  |                         |                        |
|--|-------------------------|------------------------|
| <i>Title:</i> TOS Protocol and Procedure: Plant Belowground Biomass Sampling |                         | <i>Date:</i> 01/22/219 |
| <i>NEON Doc. #:</i> NEON.DOC.014038  | <i>Author:</i> C. Meier | <i>Revision:</i> G     |

2. To collect a soil sample:
  - a. Use clippers or equivalent to remove surface vegetation and reveal the soil surface.
    - i. Remove vegetation from a surface area of approximately 10 cm x 10 cm until roots are apparent or until the surface of the organic soil layer is apparent (using criteria above).
  - b. Collect a soil sample to 30 cm maximum depth or refusal, whichever comes first.
  - c. Remove the soil sample and process according to SOP B.
3. To process soil samples with a fibric surface soil:
  - a. Cut and separate fibric organic material from more mineral-rich and decomposed organic soil before sieving – fibric material will not sieve easily and should not be passed through the sieve stack. Typical organic soil will pass through the sieve stack.
  - b. From the fibric fraction, manually pluck larger roots and then float and wet-pick the remaining material to remove smaller diameter roots and fragments  $\geq 1$  cm length.

|   |                  |                 |
|---|------------------|-----------------|
| Title: TOS Protocol and Procedure: Plant Belowground Biomass Sampling |                  | Date: 01/22/219 |
| NEON Doc. #: NEON.DOC.014038  | Author: C. Meier | Revision: G     |

**APPENDIX E SOIL CORE ASSEMBLY**



**Figure 17.** Component parts of the Giddings soil core assembly.

|   |                  |                 |
|---|------------------|-----------------|
| Title: TOS Protocol and Procedure: Plant Belowground Biomass Sampling |                  | Date: 01/22/219 |
| NEON Doc. #: NEON.DOC.014038  | Author: C. Meier | Revision: G     |

**APPENDIX F MANAGING EXPOSURE TO TOXICODENDRON SPECIES**

General guidelines for preventing and mitigating exposure to toxic oils from *Toxicodendron* species can be found in RD[12].

The following are protocol-specific best-practice techniques for minimizing exposure to toxic oil during plant Belowground Biomass Sampling.

**Table 15.** Equipment list – Minimizing exposure to toxic oils from roots of *Toxicodendron spp.* that may be encountered during plant Belowground Biomass Sampling.

| Item No.                | R/S | Description  | Purpose   | Quantity  |
|-------------------------|-----|--|---|-----------|
| <b>Durable Items</b>    |     |  |   |           |
|                         | R   | Labeled clippers, dedicated to clipping <i>Toxicodendron spp.</i> (see <b>Table 5</b> )  | Prevent spread of toxic oils to multiple clippers | 1         |
|                         | R   | Labeled sieve set(s), dedicated to sieving samples containing <i>Toxicodendron</i> . (Set contains 2mm sieve and 250 µm sieve. See <b>Table 5</b> .) | Prevent spread of toxic oils to multiple sieves.  | As needed |
|                         | R   | Labeled forceps, blunt tip, stainless steel; dedicated to <i>Toxicodendron</i> samples   | Prevent spread of toxic oils to multiple forceps. | As needed |
| <b>Consumable Items</b> |     |  |   |           |
|                         | R   | See RD[12]   |   |           |

**1. Prior to field work:**

- a. Count out coin envelopes or clasp envelopes for storing and drying root samples that will likely contain *Toxicodendron* biomass. Don't mix samples containing *Toxicodendron* biomass with any other samples.
- b. Pre-weigh (to nearest 0.01 g) and label each envelope that will be used for storing and drying soil samples containing *Toxicodendron* biomass. Once the weight of each empty envelope is written on the envelope, the biomass inside the bag will never have to be touched after it is initially placed in the bag.

**2. To collect soil samples containing *Toxicodendron* biomass in the field:**

- a. Before collecting the soil sample, use a pair of clippers dedicated solely to clipping *Toxicodendron spp.* to clip and remove any aboveground *Toxicodendron* biomass that would be contacted while sampling.

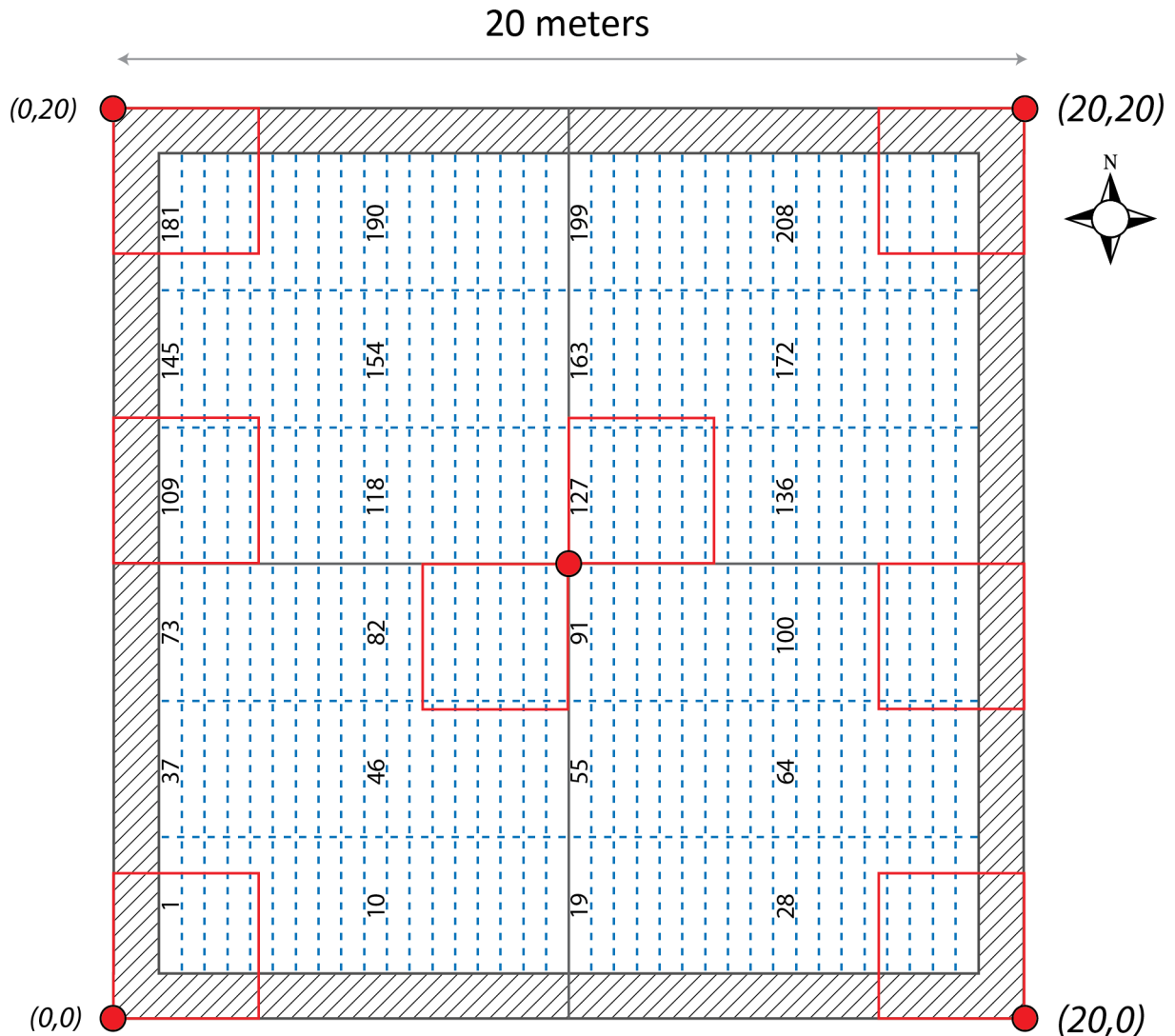
|   |                  |                 |
|---|------------------|-----------------|
| Title: TOS Protocol and Procedure: Plant Belowground Biomass Sampling |                  | Date: 01/22/219 |
| NEON Doc. #: NEON.DOC.014038  | Author: C. Meier | Revision: G     |

- b. Write 'Toxico' or equivalent on the label of any soil sample that may contain *Toxicodendron* roots.
  - c. Bring a clean, new plastic bag to the field for storing and transporting contaminated gloves, soil sampling equipment, and clippers after use.
3. **To process and weigh samples that may contain *Toxicodendron* biomass in the laboratory:**
- a. Use sieves and forceps dedicated to processing root samples containing *Toxicodendron* biomass. Wash sieves and forceps with Tecnu (or equivalent) following each use.
  - b. Minimize potential spread of toxic oil by putting envelopes containing *Toxicodendron* roots into the same drying oven every time.
  - c. When drying is complete, clean drying oven shelves used for drying *Toxicodendron* biomass with hot water and Tecnu. Wear appropriate PPE when cleaning.
  - d. Record weight of bag + dried biomass to nearest 0.001 g or 0.0001 g, and also record weight of individual empty bag (to minimum of 0.001 g) on data sheets. Dried *Toxicodendron* biomass should never leave the bag.

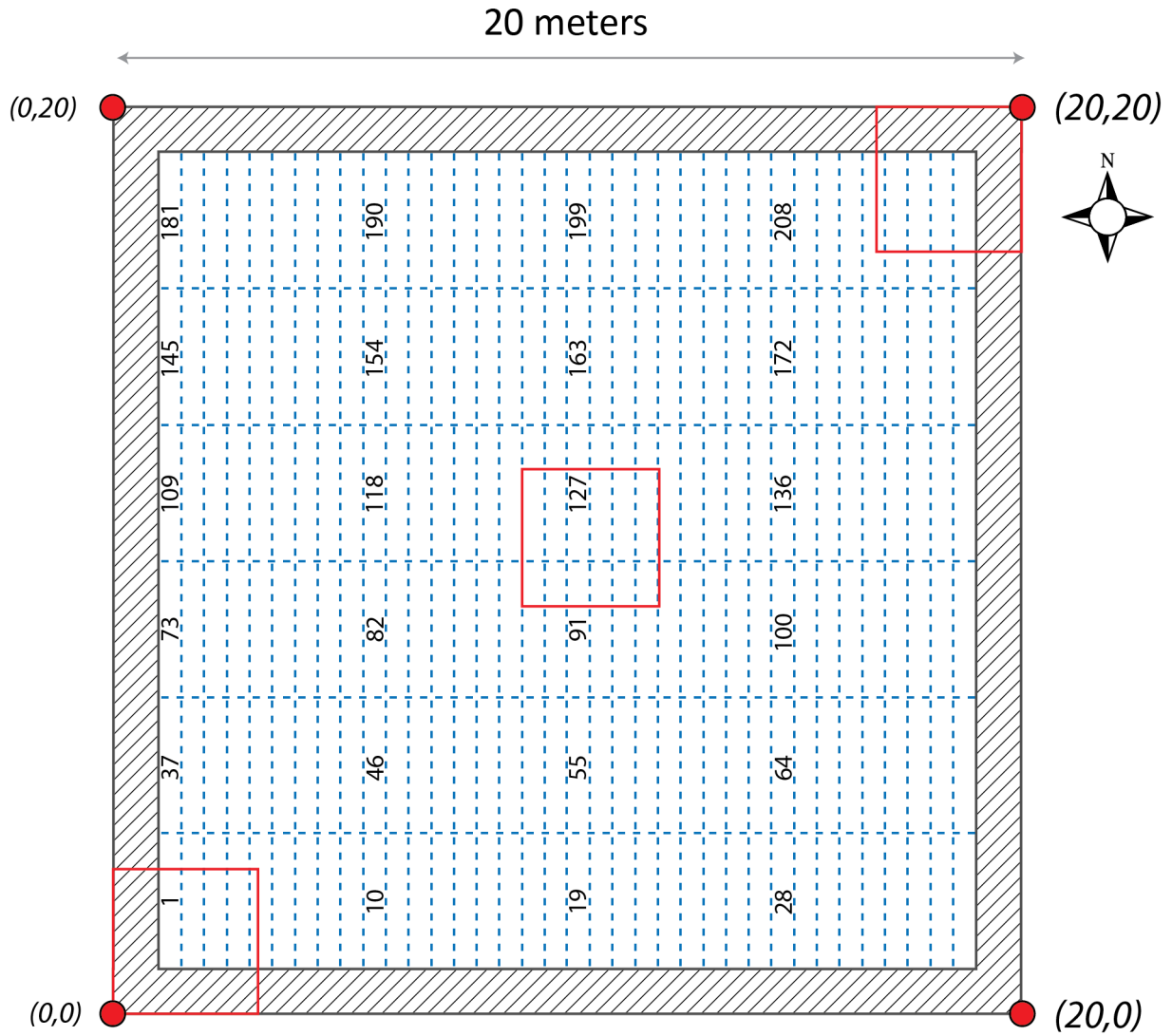
**APPENDIX G CLIPCELLNUMBER COORDINATES AND MAPS**

Plant Belowground Biomass Sampling and peak biomass clip harvest sampling ideally take place in the same clip cell in a given Tower plot. NEON Field Operations technicians must track the clip cell associated with soil sampling and peak biomass clipping on the Clip Lists provided by Science Operations. When the Herbaceous Biomass clip harvest (RD[11]) precedes soil sampling in the field, it is necessary to physically locate the clip cell in which the peak biomass clip occurred.

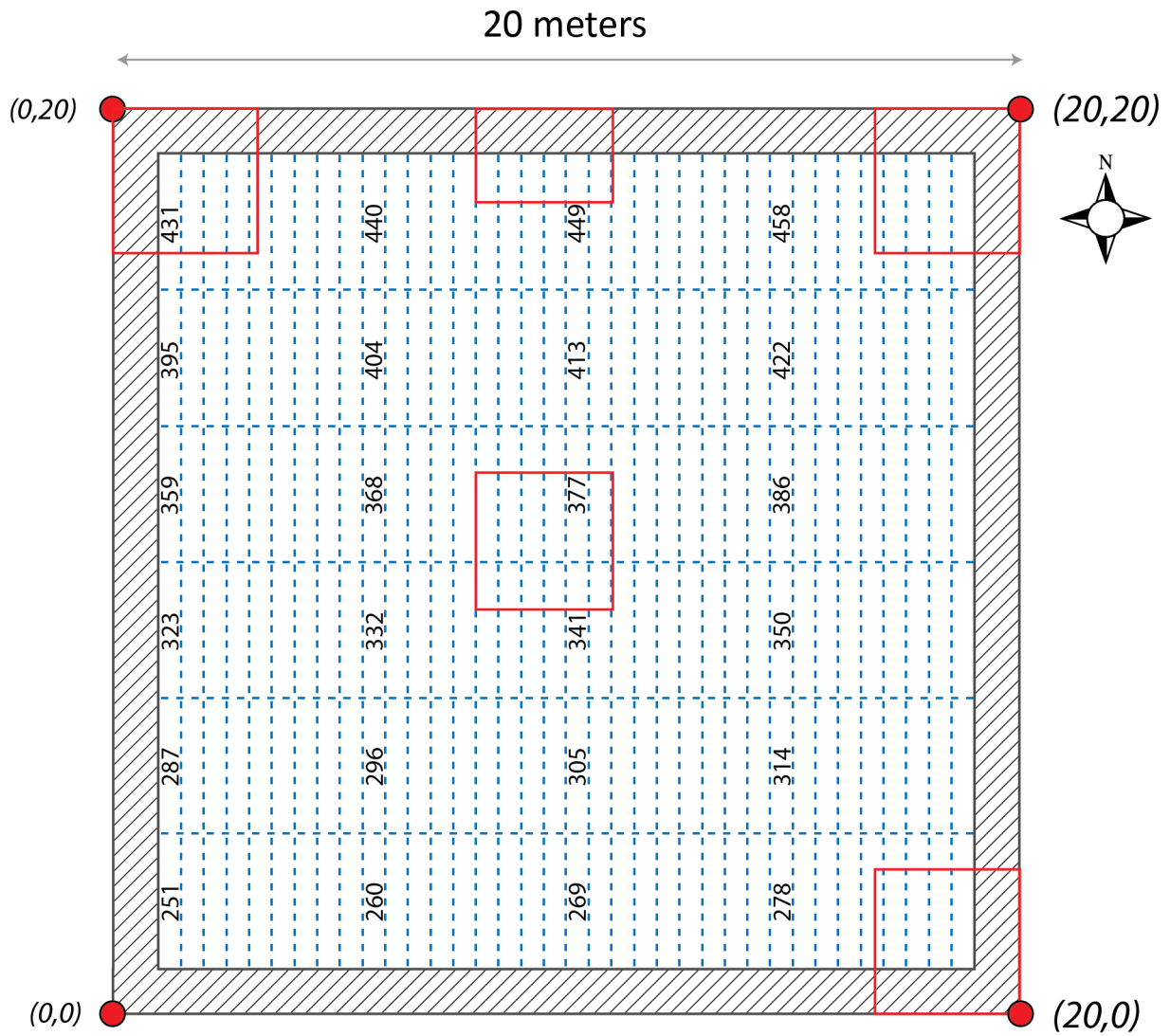
**G.1 Maps of clipCellNumber by subplotID**



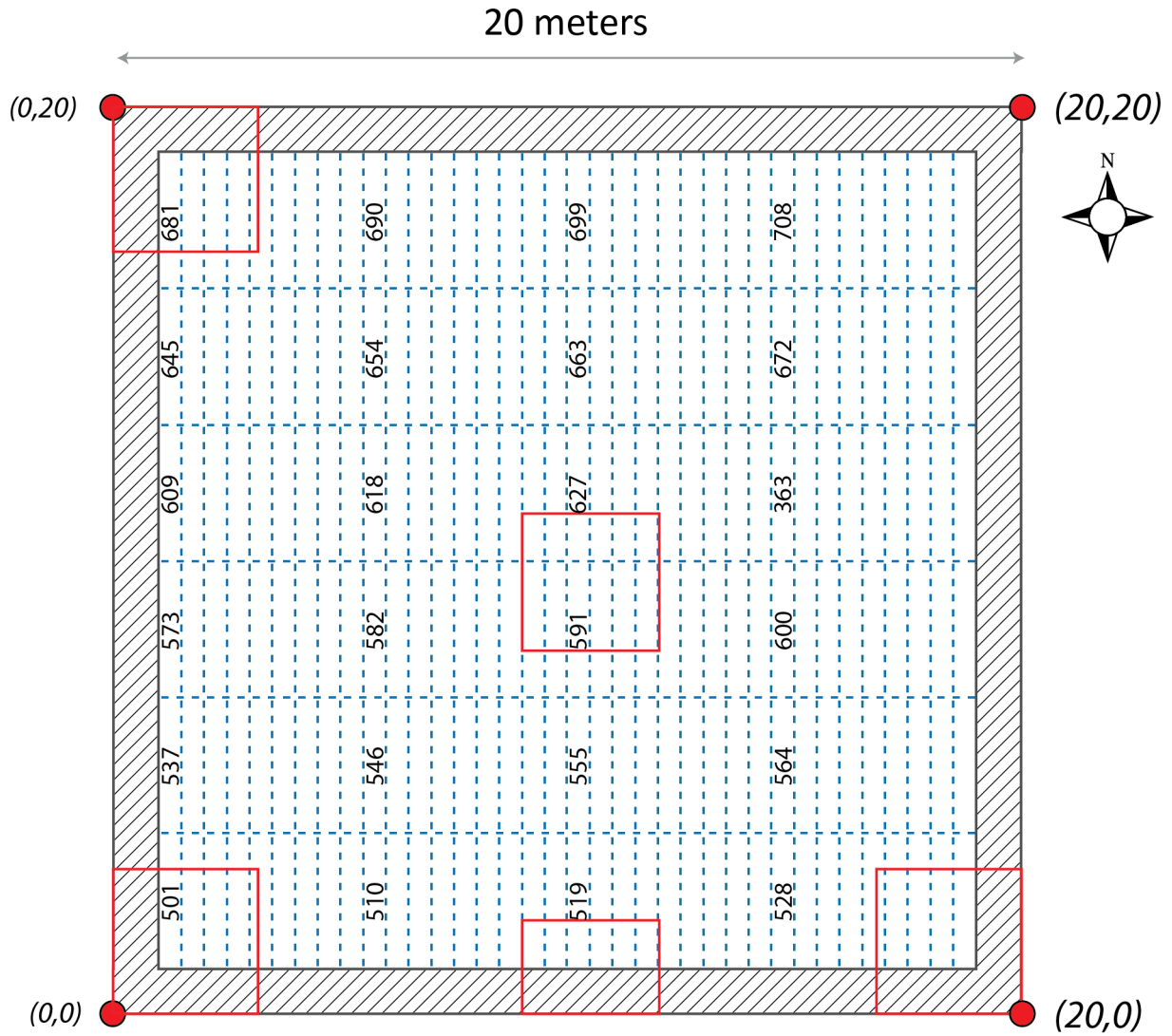
**Figure 18.** Map of clipCellNumbers in a 20m x 20m base plot (subplotID = 31 in provided Clip Lists). Red squares indicate nested subplots used for diversity sampling; clip cells that significantly overlap red squares are not used for fine root soil coring or clip sampling. However, cells with minimal overlap (e.g., 48-54, 68-72, 145-149) do support these sampling activities.



**Figure 19.** Map of clipCellNumbers for **subplotID = 21** in a 40m x 40m Tower base plot. Cells that overlap nested subplots indicated by red squares are not used for fine root soil core or clip sampling.

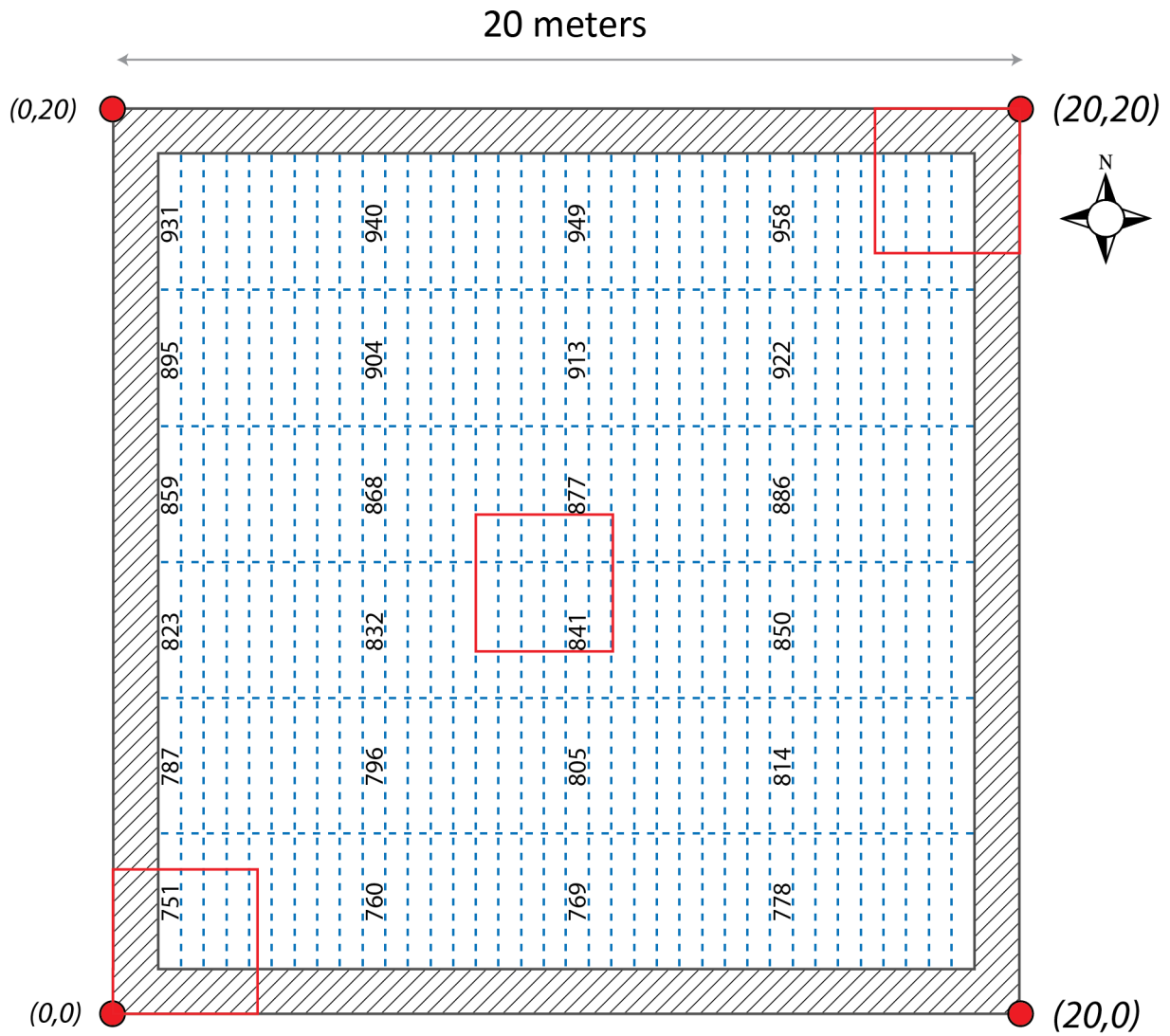


**Figure 20.** Map of clipCellNumbers for **subplotID = 23** in a 40m x 40m Tower base plot. Cells that overlap nested subplots indicated by red squares are not used for fine root soil core or clip sampling.



**Figure 21.** Map of clipCellNumbers for **subplotID = 39** in a 40m x 40m Tower base plot. Cells that overlap nested subplots indicated by red squares are not used for fine root soil core or clip sampling.





**Figure 22.** Map of clipCellNumbers for **subplotID = 41** in a 40m x 40m Tower base plot. Cells that overlap nested subplots indicated by red squares are not used for fine root soil core or clip sampling.

|   |                  |                 |
|---|------------------|-----------------|
| Title: TOS Protocol and Procedure: Plant Belowground Biomass Sampling |                  | Date: 01/22/219 |
| NEON Doc. #: NEON.DOC.014038  | Author: C. Meier | Revision: G     |

## G.2 Coordinates for clipCellNumbers by subplotID

**Table 16.** List of clipCellNumbers by subplotID and associated easting and northing coordinates. Coordinates correspond to the SW corner of a 0.1m x 2m Clip Strip, and indicate the distance in meters relative to the SW corner of the plot (subplotID = 31) or subplot (subplotID = 21, 23, 39, 41).

| clipCellNumber<br>subplotID = 31 | clipCellNumber<br>subplotID = 21 | clipCellNumber<br>subplotID = 23 | clipCellNumber<br>subplotID = 39 | clipCellNumber<br>subplotID = 41 | easting<br>offset | northing<br>offset |
|----------------------------------|----------------------------------|----------------------------------|----------------------------------|----------------------------------|-------------------|--------------------|
| 1                                | 1                                | 251                              | 501                              | 751                              | 1.2               | 1.5                |
| 2                                | 2                                | 252                              | 502                              | 752                              | 1.7               | 1.5                |
| 3                                | 3                                | 253                              | 503                              | 753                              | 2.2               | 1.5                |
| 4                                | 4                                | 254                              | 504                              | 754                              | 2.7               | 1.5                |
| 5                                | 5                                | 255                              | 505                              | 755                              | 3.2               | 1.5                |
| 6                                | 6                                | 256                              | 506                              | 756                              | 3.7               | 1.5                |
| 7                                | 7                                | 257                              | 507                              | 757                              | 4.2               | 1.5                |
| 8                                | 8                                | 258                              | 508                              | 758                              | 4.7               | 1.5                |
| 9                                | 9                                | 259                              | 509                              | 759                              | 5.2               | 1.5                |
| 10                               | 10                               | 260                              | 510                              | 760                              | 5.7               | 1.5                |
| 11                               | 11                               | 261                              | 511                              | 761                              | 6.2               | 1.5                |
| 12                               | 12                               | 262                              | 512                              | 762                              | 6.7               | 1.5                |
| 13                               | 13                               | 263                              | 513                              | 763                              | 7.2               | 1.5                |
| 14                               | 14                               | 264                              | 514                              | 764                              | 7.7               | 1.5                |
| 15                               | 15                               | 265                              | 515                              | 765                              | 8.2               | 1.5                |
| 16                               | 16                               | 266                              | 516                              | 766                              | 8.7               | 1.5                |
| 17                               | 17                               | 267                              | 517                              | 767                              | 9.2               | 1.5                |
| 18                               | 18                               | 268                              | 518                              | 768                              | 9.7               | 1.5                |
| 19                               | 19                               | 269                              | 519                              | 769                              | 10.2              | 1.5                |
| 20                               | 20                               | 270                              | 520                              | 770                              | 10.7              | 1.5                |
| 21                               | 21                               | 271                              | 521                              | 771                              | 11.2              | 1.5                |
| 22                               | 22                               | 272                              | 522                              | 772                              | 11.7              | 1.5                |
| 23                               | 23                               | 273                              | 523                              | 773                              | 12.2              | 1.5                |
| 24                               | 24                               | 274                              | 524                              | 774                              | 12.7              | 1.5                |
| 25                               | 25                               | 275                              | 525                              | 775                              | 13.2              | 1.5                |
| 26                               | 26                               | 276                              | 526                              | 776                              | 13.7              | 1.5                |
| 27                               | 27                               | 277                              | 527                              | 777                              | 14.2              | 1.5                |
| 28                               | 28                               | 278                              | 528                              | 778                              | 14.7              | 1.5                |
| 29                               | 29                               | 279                              | 529                              | 779                              | 15.2              | 1.5                |
| 30                               | 30                               | 280                              | 530                              | 780                              | 15.7              | 1.5                |
| 31                               | 31                               | 281                              | 531                              | 781                              | 16.2              | 1.5                |
| 32                               | 32                               | 282                              | 532                              | 782                              | 16.7              | 1.5                |
| 33                               | 33                               | 283                              | 533                              | 783                              | 17.2              | 1.5                |
| 34                               | 34                               | 284                              | 534                              | 784                              | 17.7              | 1.5                |
| 35                               | 35                               | 285                              | 535                              | 785                              | 18.2              | 1.5                |
| 36                               | 36                               | 286                              | 536                              | 786                              | 18.7              | 1.5                |
| 37                               | 37                               | 287                              | 537                              | 787                              | 1.2               | 4.5                |

|   |                  |                 |
|---|------------------|-----------------|
| Title: TOS Protocol and Procedure: Plant Belowground Biomass Sampling |                  | Date: 01/22/219 |
| NEON Doc. #: NEON.DOC.014038  | Author: C. Meier | Revision: G     |

| clipCellNumber subplotID = 31 | clipCellNumber subplotID = 21 | clipCellNumber subplotID = 23 | clipCellNumber subplotID = 39 | clipCellNumber subplotID = 41 | easting offset | northing offset |
|-------------------------------|-------------------------------|-------------------------------|-------------------------------|-------------------------------|----------------|-----------------|
| 38                            | 38                            | 288                           | 538                           | 788                           | 1.7            | 4.5             |
| 39                            | 39                            | 289                           | 539                           | 789                           | 2.2            | 4.5             |
| 40                            | 40                            | 290                           | 540                           | 790                           | 2.7            | 4.5             |
| 41                            | 41                            | 291                           | 541                           | 791                           | 3.2            | 4.5             |
| 42                            | 42                            | 292                           | 542                           | 792                           | 3.7            | 4.5             |
| 43                            | 43                            | 293                           | 543                           | 793                           | 4.2            | 4.5             |
| 44                            | 44                            | 294                           | 544                           | 794                           | 4.7            | 4.5             |
| 45                            | 45                            | 295                           | 545                           | 795                           | 5.2            | 4.5             |
| 46                            | 46                            | 296                           | 546                           | 796                           | 5.7            | 4.5             |
| 47                            | 47                            | 297                           | 547                           | 797                           | 6.2            | 4.5             |
| 48                            | 48                            | 298                           | 548                           | 798                           | 6.7            | 4.5             |
| 49                            | 49                            | 299                           | 549                           | 799                           | 7.2            | 4.5             |
| 50                            | 50                            | 300                           | 550                           | 800                           | 7.7            | 4.5             |
| 51                            | 51                            | 301                           | 551                           | 801                           | 8.2            | 4.5             |
| 52                            | 52                            | 302                           | 552                           | 802                           | 8.7            | 4.5             |
| 53                            | 53                            | 303                           | 553                           | 803                           | 9.2            | 4.5             |
| 54                            | 54                            | 304                           | 554                           | 804                           | 9.7            | 4.5             |
| 55                            | 55                            | 305                           | 555                           | 805                           | 10.2           | 4.5             |
| 56                            | 56                            | 306                           | 556                           | 806                           | 10.7           | 4.5             |
| 57                            | 57                            | 307                           | 557                           | 807                           | 11.2           | 4.5             |
| 58                            | 58                            | 308                           | 558                           | 808                           | 11.7           | 4.5             |
| 59                            | 59                            | 309                           | 559                           | 809                           | 12.2           | 4.5             |
| 60                            | 60                            | 310                           | 560                           | 810                           | 12.7           | 4.5             |
| 61                            | 61                            | 311                           | 561                           | 811                           | 13.2           | 4.5             |
| 62                            | 62                            | 312                           | 562                           | 812                           | 13.7           | 4.5             |
| 63                            | 63                            | 313                           | 563                           | 813                           | 14.2           | 4.5             |
| 64                            | 64                            | 314                           | 564                           | 814                           | 14.7           | 4.5             |
| 65                            | 65                            | 315                           | 565                           | 815                           | 15.2           | 4.5             |
| 66                            | 66                            | 316                           | 566                           | 816                           | 15.7           | 4.5             |
| 67                            | 67                            | 317                           | 567                           | 817                           | 16.2           | 4.5             |
| 68                            | 68                            | 318                           | 568                           | 818                           | 16.7           | 4.5             |
| 69                            | 69                            | 319                           | 569                           | 819                           | 17.2           | 4.5             |
| 70                            | 70                            | 320                           | 570                           | 820                           | 17.7           | 4.5             |
| 71                            | 71                            | 321                           | 571                           | 821                           | 18.2           | 4.5             |
| 72                            | 72                            | 322                           | 572                           | 822                           | 18.7           | 4.5             |
| 73                            | 73                            | 323                           | 573                           | 823                           | 1.2            | 7.5             |
| 74                            | 74                            | 324                           | 574                           | 824                           | 1.7            | 7.5             |
| 75                            | 75                            | 325                           | 575                           | 825                           | 2.2            | 7.5             |
| 76                            | 76                            | 326                           | 576                           | 826                           | 2.7            | 7.5             |
| 77                            | 77                            | 327                           | 577                           | 827                           | 3.2            | 7.5             |
| 78                            | 78                            | 328                           | 578                           | 828                           | 3.7            | 7.5             |
| 79                            | 79                            | 329                           | 579                           | 829                           | 4.2            | 7.5             |

|   |                  |                 |
|---|------------------|-----------------|
| Title: TOS Protocol and Procedure: Plant Belowground Biomass Sampling |                  | Date: 01/22/219 |
| NEON Doc. #: NEON.DOC.014038  | Author: C. Meier | Revision: G     |

| clipCellNumber subplotID = 31 | clipCellNumber subplotID = 21 | clipCellNumber subplotID = 23 | clipCellNumber subplotID = 39 | clipCellNumber subplotID = 41 | easting offset | northing offset |
|-------------------------------|-------------------------------|-------------------------------|-------------------------------|-------------------------------|----------------|-----------------|
| 80                            | 80                            | 330                           | 580                           | 830                           | 4.7            | 7.5             |
| 81                            | 81                            | 331                           | 581                           | 831                           | 5.2            | 7.5             |
| 82                            | 82                            | 332                           | 582                           | 832                           | 5.7            | 7.5             |
| 83                            | 83                            | 333                           | 583                           | 833                           | 6.2            | 7.5             |
| 84                            | 84                            | 334                           | 584                           | 834                           | 6.7            | 7.5             |
| 85                            | 85                            | 335                           | 585                           | 835                           | 7.2            | 7.5             |
| 86                            | 86                            | 336                           | 586                           | 836                           | 7.7            | 7.5             |
| 87                            | 87                            | 337                           | 587                           | 837                           | 8.2            | 7.5             |
| 88                            | 88                            | 338                           | 588                           | 838                           | 8.7            | 7.5             |
| 89                            | 89                            | 339                           | 589                           | 839                           | 9.2            | 7.5             |
| 90                            | 90                            | 340                           | 590                           | 840                           | 9.7            | 7.5             |
| 91                            | 91                            | 341                           | 591                           | 841                           | 10.2           | 7.5             |
| 92                            | 92                            | 342                           | 592                           | 842                           | 10.7           | 7.5             |
| 93                            | 93                            | 343                           | 593                           | 843                           | 11.2           | 7.5             |
| 94                            | 94                            | 344                           | 594                           | 844                           | 11.7           | 7.5             |
| 95                            | 95                            | 345                           | 595                           | 845                           | 12.2           | 7.5             |
| 96                            | 96                            | 346                           | 596                           | 846                           | 12.7           | 7.5             |
| 97                            | 97                            | 347                           | 597                           | 847                           | 13.2           | 7.5             |
| 98                            | 98                            | 348                           | 598                           | 848                           | 13.7           | 7.5             |
| 99                            | 99                            | 349                           | 599                           | 849                           | 14.2           | 7.5             |
| 100                           | 100                           | 350                           | 600                           | 850                           | 14.7           | 7.5             |
| 101                           | 101                           | 351                           | 601                           | 851                           | 15.2           | 7.5             |
| 102                           | 102                           | 352                           | 602                           | 852                           | 15.7           | 7.5             |
| 103                           | 103                           | 353                           | 603                           | 853                           | 16.2           | 7.5             |
| 104                           | 104                           | 354                           | 604                           | 854                           | 16.7           | 7.5             |
| 105                           | 105                           | 355                           | 605                           | 855                           | 17.2           | 7.5             |
| 106                           | 106                           | 356                           | 606                           | 856                           | 17.7           | 7.5             |
| 107                           | 107                           | 357                           | 607                           | 857                           | 18.2           | 7.5             |
| 108                           | 108                           | 358                           | 608                           | 858                           | 18.7           | 7.5             |
| 109                           | 109                           | 359                           | 609                           | 859                           | 1.2            | 10.5            |
| 110                           | 110                           | 360                           | 610                           | 860                           | 1.7            | 10.5            |
| 111                           | 111                           | 361                           | 611                           | 861                           | 2.2            | 10.5            |
| 112                           | 112                           | 362                           | 612                           | 862                           | 2.7            | 10.5            |
| 113                           | 113                           | 363                           | 613                           | 863                           | 3.2            | 10.5            |
| 114                           | 114                           | 364                           | 614                           | 864                           | 3.7            | 10.5            |
| 115                           | 115                           | 365                           | 615                           | 865                           | 4.2            | 10.5            |
| 116                           | 116                           | 366                           | 616                           | 866                           | 4.7            | 10.5            |
| 117                           | 117                           | 367                           | 617                           | 867                           | 5.2            | 10.5            |
| 118                           | 118                           | 368                           | 618                           | 868                           | 5.7            | 10.5            |
| 119                           | 119                           | 369                           | 619                           | 869                           | 6.2            | 10.5            |
| 120                           | 120                           | 370                           | 620                           | 870                           | 6.7            | 10.5            |
| 121                           | 121                           | 371                           | 621                           | 871                           | 7.2            | 10.5            |

|   |                  |                 |
|---|------------------|-----------------|
| Title: TOS Protocol and Procedure: Plant Belowground Biomass Sampling |                  | Date: 01/22/219 |
| NEON Doc. #: NEON.DOC.014038  | Author: C. Meier | Revision: G     |

| clipCellNumber subplotID = 31 | clipCellNumber subplotID = 21 | clipCellNumber subplotID = 23 | clipCellNumber subplotID = 39 | clipCellNumber subplotID = 41 | easting offset | northing offset |
|-------------------------------|-------------------------------|-------------------------------|-------------------------------|-------------------------------|----------------|-----------------|
| 122                           | 122                           | 372                           | 622                           | 872                           | 7.7            | 10.5            |
| 123                           | 123                           | 373                           | 623                           | 873                           | 8.2            | 10.5            |
| 124                           | 124                           | 374                           | 624                           | 874                           | 8.7            | 10.5            |
| 125                           | 125                           | 375                           | 625                           | 875                           | 9.2            | 10.5            |
| 126                           | 126                           | 376                           | 626                           | 876                           | 9.7            | 10.5            |
| 127                           | 127                           | 377                           | 627                           | 877                           | 10.2           | 10.5            |
| 128                           | 128                           | 378                           | 628                           | 878                           | 10.7           | 10.5            |
| 129                           | 129                           | 379                           | 629                           | 879                           | 11.2           | 10.5            |
| 130                           | 130                           | 380                           | 630                           | 880                           | 11.7           | 10.5            |
| 131                           | 131                           | 381                           | 631                           | 881                           | 12.2           | 10.5            |
| 132                           | 132                           | 382                           | 632                           | 882                           | 12.7           | 10.5            |
| 133                           | 133                           | 383                           | 633                           | 883                           | 13.2           | 10.5            |
| 134                           | 134                           | 384                           | 634                           | 884                           | 13.7           | 10.5            |
| 135                           | 135                           | 385                           | 635                           | 885                           | 14.2           | 10.5            |
| 136                           | 136                           | 386                           | 636                           | 886                           | 14.7           | 10.5            |
| 137                           | 137                           | 387                           | 637                           | 887                           | 15.2           | 10.5            |
| 138                           | 138                           | 388                           | 638                           | 888                           | 15.7           | 10.5            |
| 139                           | 139                           | 389                           | 639                           | 889                           | 16.2           | 10.5            |
| 140                           | 140                           | 390                           | 640                           | 890                           | 16.7           | 10.5            |
| 141                           | 141                           | 391                           | 641                           | 891                           | 17.2           | 10.5            |
| 142                           | 142                           | 392                           | 642                           | 892                           | 17.7           | 10.5            |
| 143                           | 143                           | 393                           | 643                           | 893                           | 18.2           | 10.5            |
| 144                           | 144                           | 394                           | 644                           | 894                           | 18.7           | 10.5            |
| 145                           | 145                           | 395                           | 645                           | 895                           | 1.2            | 13.5            |
| 146                           | 146                           | 396                           | 646                           | 896                           | 1.7            | 13.5            |
| 147                           | 147                           | 397                           | 647                           | 897                           | 2.2            | 13.5            |
| 148                           | 148                           | 398                           | 648                           | 898                           | 2.7            | 13.5            |
| 149                           | 149                           | 399                           | 649                           | 899                           | 3.2            | 13.5            |
| 150                           | 150                           | 400                           | 650                           | 900                           | 3.7            | 13.5            |
| 151                           | 151                           | 401                           | 651                           | 901                           | 4.2            | 13.5            |
| 152                           | 152                           | 402                           | 652                           | 902                           | 4.7            | 13.5            |
| 153                           | 153                           | 403                           | 653                           | 903                           | 5.2            | 13.5            |
| 154                           | 154                           | 404                           | 654                           | 904                           | 5.7            | 13.5            |
| 155                           | 155                           | 405                           | 655                           | 905                           | 6.2            | 13.5            |
| 156                           | 156                           | 406                           | 656                           | 906                           | 6.7            | 13.5            |
| 157                           | 157                           | 407                           | 657                           | 907                           | 7.2            | 13.5            |
| 158                           | 158                           | 408                           | 658                           | 908                           | 7.7            | 13.5            |
| 159                           | 159                           | 409                           | 659                           | 909                           | 8.2            | 13.5            |
| 160                           | 160                           | 410                           | 660                           | 910                           | 8.7            | 13.5            |
| 161                           | 161                           | 411                           | 661                           | 911                           | 9.2            | 13.5            |
| 162                           | 162                           | 412                           | 662                           | 912                           | 9.7            | 13.5            |
| 163                           | 163                           | 413                           | 663                           | 913                           | 10.2           | 13.5            |

|   |                  |                 |
|---|------------------|-----------------|
| Title: TOS Protocol and Procedure: Plant Belowground Biomass Sampling |                  | Date: 01/22/219 |
| NEON Doc. #: NEON.DOC.014038  | Author: C. Meier | Revision: G     |

| clipCellNumber subplotID = 31 | clipCellNumber subplotID = 21 | clipCellNumber subplotID = 23 | clipCellNumber subplotID = 39 | clipCellNumber subplotID = 41 | easting offset | northing offset |
|-------------------------------|-------------------------------|-------------------------------|-------------------------------|-------------------------------|----------------|-----------------|
| 164                           | 164                           | 414                           | 664                           | 914                           | 10.7           | 13.5            |
| 165                           | 165                           | 415                           | 665                           | 915                           | 11.2           | 13.5            |
| 166                           | 166                           | 416                           | 666                           | 916                           | 11.7           | 13.5            |
| 167                           | 167                           | 417                           | 667                           | 917                           | 12.2           | 13.5            |
| 168                           | 168                           | 418                           | 668                           | 918                           | 12.7           | 13.5            |
| 169                           | 169                           | 419                           | 669                           | 919                           | 13.2           | 13.5            |
| 170                           | 170                           | 420                           | 670                           | 920                           | 13.7           | 13.5            |
| 171                           | 171                           | 421                           | 671                           | 921                           | 14.2           | 13.5            |
| 172                           | 172                           | 422                           | 672                           | 922                           | 14.7           | 13.5            |
| 173                           | 173                           | 423                           | 673                           | 923                           | 15.2           | 13.5            |
| 174                           | 174                           | 424                           | 674                           | 924                           | 15.7           | 13.5            |
| 175                           | 175                           | 425                           | 675                           | 925                           | 16.2           | 13.5            |
| 176                           | 176                           | 426                           | 676                           | 926                           | 16.7           | 13.5            |
| 177                           | 177                           | 427                           | 677                           | 927                           | 17.2           | 13.5            |
| 178                           | 178                           | 428                           | 678                           | 928                           | 17.7           | 13.5            |
| 179                           | 179                           | 429                           | 679                           | 929                           | 18.2           | 13.5            |
| 180                           | 180                           | 430                           | 680                           | 930                           | 18.7           | 13.5            |
| 181                           | 181                           | 431                           | 681                           | 931                           | 1.2            | 16.5            |
| 182                           | 182                           | 432                           | 682                           | 932                           | 1.7            | 16.5            |
| 183                           | 183                           | 433                           | 683                           | 933                           | 2.2            | 16.5            |
| 184                           | 184                           | 434                           | 684                           | 934                           | 2.7            | 16.5            |
| 185                           | 185                           | 435                           | 685                           | 935                           | 3.2            | 16.5            |
| 186                           | 186                           | 436                           | 686                           | 936                           | 3.7            | 16.5            |
| 187                           | 187                           | 437                           | 687                           | 937                           | 4.2            | 16.5            |
| 188                           | 188                           | 438                           | 688                           | 938                           | 4.7            | 16.5            |
| 189                           | 189                           | 439                           | 689                           | 939                           | 5.2            | 16.5            |
| 190                           | 190                           | 440                           | 690                           | 940                           | 5.7            | 16.5            |
| 191                           | 191                           | 441                           | 691                           | 941                           | 6.2            | 16.5            |
| 192                           | 192                           | 442                           | 692                           | 942                           | 6.7            | 16.5            |
| 193                           | 193                           | 443                           | 693                           | 943                           | 7.2            | 16.5            |
| 194                           | 194                           | 444                           | 694                           | 944                           | 7.7            | 16.5            |
| 195                           | 195                           | 445                           | 695                           | 945                           | 8.2            | 16.5            |
| 196                           | 196                           | 446                           | 696                           | 946                           | 8.7            | 16.5            |
| 197                           | 197                           | 447                           | 697                           | 947                           | 9.2            | 16.5            |
| 198                           | 198                           | 448                           | 698                           | 948                           | 9.7            | 16.5            |
| 199                           | 199                           | 449                           | 699                           | 949                           | 10.2           | 16.5            |
| 200                           | 200                           | 450                           | 700                           | 950                           | 10.7           | 16.5            |
| 201                           | 201                           | 451                           | 701                           | 951                           | 11.2           | 16.5            |
| 202                           | 202                           | 452                           | 702                           | 952                           | 11.7           | 16.5            |
| 203                           | 203                           | 453                           | 703                           | 953                           | 12.2           | 16.5            |
| 204                           | 204                           | 454                           | 704                           | 954                           | 12.7           | 16.5            |
| 205                           | 205                           | 455                           | 705                           | 955                           | 13.2           | 16.5            |

|  |                         |                        |
|--|-------------------------|------------------------|
| <i>Title:</i> TOS Protocol and Procedure: Plant Belowground Biomass Sampling |                         | <i>Date:</i> 01/22/219 |
| <i>NEON Doc. #:</i> NEON.DOC.014038  | <i>Author:</i> C. Meier | <i>Revision:</i> G     |

| clipCellNumber<br>subplotID = 31 | clipCellNumber<br>subplotID = 21 | clipCellNumber<br>subplotID = 23 | clipCellNumber<br>subplotID = 39 | clipCellNumber<br>subplotID = 41 | easting<br>offset | northing<br>offset |
|----------------------------------|----------------------------------|----------------------------------|----------------------------------|----------------------------------|-------------------|--------------------|
| 206                              | 206                              | 456                              | 706                              | 956                              | 13.7              | 16.5               |
| 207                              | 207                              | 457                              | 707                              | 957                              | 14.2              | 16.5               |
| 208                              | 208                              | 458                              | 708                              | 958                              | 14.7              | 16.5               |
| 209                              | 209                              | 459                              | 709                              | 959                              | 15.2              | 16.5               |
| 210                              | 210                              | 460                              | 710                              | 960                              | 15.7              | 16.5               |
| 211                              | 211                              | 461                              | 711                              | 961                              | 16.2              | 16.5               |
| 212                              | 212                              | 462                              | 712                              | 962                              | 16.7              | 16.5               |
| 213                              | 213                              | 463                              | 713                              | 963                              | 17.2              | 16.5               |
| 214                              | 214                              | 464                              | 714                              | 964                              | 17.7              | 16.5               |
| 215                              | 215                              | 465                              | 715                              | 965                              | 18.2              | 16.5               |
| 216                              | 216                              | 466                              | 716                              | 966                              | 18.7              | 16.5               |