

<i>Title:</i> D17 FIU Site Characterization: Supporting Data	<i>Author:</i> Luo/ Ayres/Loescher	<i>Date:</i> 09/26/2011
<i>NEON Doc. #:</i> NEON.DOC.011077		<i>Revision:</i> B

D17 FIU Site Characterization Supporting Data

PREPARED BY	ORGANIZATION	DATE
H Luo /E Ayres/H Loescher	FIU	03/04/2011

APPROVALS (Name)	ORGANIZATION	APPROVAL DATE
Hank Loescher	FIU	11/04/2011

RELEASED BY (Name)	ORGANIZATION	RELEASE DATE
Anne Balsley	CCB Administrator/DCS	11/07/2011

See Configuration Management System for approval history.

<i>Title:</i> D17 FIU Site Characterization: Supporting Data	<i>Author:</i> Luo/ Ayres/Loescher	<i>Date:</i> 09/26/2011
<i>NEON Doc. #:</i> NEON.DOC.011077		<i>Revision:</i> B

Change Record

REVISION	DATE	ECO #	DESCRIPTION OF CHANGE
A	3/04/2011	ECO-00076	INITIAL RELEASE
B	09/26/2011	ECO-00279	Update to new document number's/template throughout document.

Title: D17 FIU Site Characterization: Supporting Data	Author: Luo/ Ayres/Loescher	Date: 09/26/2011
NEON Doc. #: NEON.DOC.011077		Revision: B

TABLE OF CONTENTS

1 DESCRIPTION..... 1

 1.1 Purpose 1

 1.2 Scope..... 1

2 RELATED DOCUMENTS AND ACRONYMS..... 2

 2.1 Applicable Documents 2

 2.2 Reference Documents..... 2

 2.3 Acronyms 2

 2.4 Verb Convention 2

3 SAN JOAQUIN EXPERIMENTAL RANGE ADVANCED TOWER SITE 3

 3.1 Site description 3

 3.2 Ecosystem 6

 3.3 Soils 8

 3.3.1 Soil description 8

 3.3.2 Soil semi-variogram description..... 13

 3.3.3 Results and interpretation 15

 3.4 Airshed 19

 3.4.1 Seasonal windroses 19

 3.4.2 Results (graphs for wind roses) 20

 3.4.3 Resultant vectors..... 20

 3.4.4 Expected environmental controls on source area 20

 3.4.5 Results (source area graphs) 23

 3.5 Site design and tower attributes 29

 3.6 Information for ecosystem productivity plots 32

 3.7 Issues and attentions 33

4 SOAPROOT SADDLE, RELOCATEABLE TOWER 1..... 34

 4.1 Site description 34

 4.2 Ecosystem 36

 4.3 Soils 38

 4.3.1 Description of soils 38

 4.3.2 Soil semi-variogram description..... 44

 4.3.3 Results and interpretation 46

 4.4 Airshed 50

Title: D17 FIU Site Characterization: Supporting Data	Author: Luo/ Ayres/Loescher	Date: 09/26/2011
NEON Doc. #: NEON.DOC.011077		Revision: B

4.4.1	Seasonal windroses	50
4.4.2	Results (graphs for wind roses)	50
4.4.3	Resultant vectors.....	53
4.4.4	Expected environmental controls on source area	53
4.4.5	Results (source area graphs)	55
4.5	Site design and tower attributes	61
4.6	Information for ecosystem productivity plots	64
4.7	Issues and attentions	64
5	LOWER TEAKETTLE, RELOCATEABLE TOWER 2	65
5.1	Site description	65
5.2	Ecosystem	66
5.3	Soils	69
5.3.1	Description of soils	69
5.3.2	Soil semi-variogram description.....	74
5.3.3	Results and interpretation	76
5.4	Airshed	80
5.4.1	Seasonal windroses	80
5.4.2	Results (graphs for wind roses)	80
5.4.3	Resultant vectors.....	83
5.4.4	Expected environmental controls on source area	83
5.4.5	Results (source area graphs)	85
5.5	Site design and tower attributes	91
5.6	Information for ecosystem productivity plots	94
5.7	Issues and attentions	94
6	REFERENCES:	96

LIST OF TABLES

Table 1.	Percent Land cover type at San Joaquin site	6
Table 2.	Ecosystem and site attributes for San Joaquin tower site.	8
Table 3.	Soil Series and percentage of soil series within 7.9 km ² around the tower.	10
Table 4.	Summary of soil array and soil pit information at San Joaquin. 0° represents true north and accounts for declination.	18
Table 5.	Expected environmental controls to parameterize the source area model, and associated results from San Joaquin advanced site.	21
Table 6.	Site design and tower attributes for San Joaquin Advanced site.	30
Table 7.	Percent Land cover information at the Soaproot Saddle relocatable site (from USGS, http://landfire.cr.usgs.gov/viewer/viewer.htm)	36

Title: D17 FIU Site Characterization: Supporting Data	Author: Luo/ Ayres/Loescher	Date: 09/26/2011
NEON Doc. #: NEON.DOC.011077		Revision: B

Table 8. Ecosystem and site attributes for Soaproot Saddle Relocatable site. 38

Table 9. Soil series and percentage of soil series within 9.0 km² at the Soaproot Saddle site 40

Table 10. Summary of soil array and soil pit information at Soaproot Saddle. 0° represents true north and accounts for declination. 49

Table 11. The resultant wind vectors from Klemme using hourly data in 2007..... 53

Table 12. Expected environmental controls to parameterize the source area model and associated results from Soaproot Saddle tower site. 54

Table 13. Site design and tower attributes for Soaproot Saddle Relocatable site 61

Table 14. Percent Land cover information at the Lower Teakettle relocatable site (from USGS, <http://landfire.cr.usgs.gov/viewer/viewer.htm>) 67

Table 15. Ecosystem and site attributes for the Lower Teakettle Relocatable site. 68

Table 16. Soil series and percentage of soil series within 3.3 km² at the Lower Teakettle site 71

Table 17. Summary of soil array and soil pit information at Lower Teakettle. 0° represents true north and accounts for declination. 79

Table 18. The resultant wind vectors for Lower Teakettle Relocatable site using hourly data in 2007-2009. 83

Table 19. Expected environmental controls to parameterize the source area model and associated results for Lower Teakettle Relocatable tower site..... 84

Table 20. Site design and tower attributes for Lower Teakettle Relocatable site 92

LIST OF FIGURES

Figure 1. Boundary map for San Joaquin Site and original candidate tower location. 5

Figure 2. Vegetative cover map of San Joaquin site and surrounding areas..... 6

Figure 3 Oak Savanna is the dominant vegetation type at San Joaquin site 7

Figure 4. Soil map for San Joaquin NEON advanced tower site. 9

Figure 5. Example semivariogram, depicting range, sill, and nugget. 13

Figure 6. Spatially cyclic sampling design for the measurements of soil temperature and soil water content..... 14

Figure 7. Left graph: mobile (circles) and stationary (line) soil temperature data. Center graph: temperature data after correcting for changes in temperature in the stationary data (circles) and a linear regression based on time of day (line). Right graph: residual temperature data after correcting for changes temperature in the stationary data and the time of day regression. Data in the right graph were used for the semivariogram analysis. 15

Figure 8. Left graphs: exploratory data analysis plots for residuals of temperature. Center graph: directional semivariograms for residuals of temperature. Right graph: empirical semivariogram (circles) and model (line) fit to residuals of temperature. 16

Figure 9. Left graph: mobile (circles) and stationary (line) soil water content data. Center graph: water content data after correcting for changes in water content in the stationary data (circles) and a linear regression based on time of day (line). Right graph: residual water content data after correcting for changes water content in the stationary data and the time of day regression. Data in the right graph were used for the semivariogram analysis. 16

Figure 10. Left graphs: exploratory data analysis plots for residuals of soil water content. Center graph: directional semivariograms for residuals of water content. Right graph: empirical semivariogram (circles) and model (line) fit to residuals of water content. 17

Figure 11. Site layout at San Joaquin showing soil array and location of the FIU soil pit. Note that there is an existing tower site nearby, and minimal interference is needed during construction. 19

Title: D17 FIU Site Characterization: Supporting Data	Author: Luo/ Ayres/Loescher	Date: 09/26/2011
NEON Doc. #: NEON.DOC.011077		Revision: B

Figure 12. Windroses from the San Joaquin Core site..... 20

Figure 13. San Joaquin summer daytime (convective) footprint output with max wind speed. 23

Figure 14. San Joaquin summer daytime (convective) footprint output with mean wind speed. 24

Figure 15. San Joaquin summer nighttime (stable) footprint output with mean wind speed. 25

Figure 16. San Joaquin winter daytime (convective) footprint output with max wind speed. 26

Figure 17. San Joaquin winter daytime (convective) footprint output with mean wind speed..... 27

Figure 18. San Joaquin winter nighttime (stable) footprint output with mean wind speed..... 28

Figure 19. San Joaquin tower airshed..... 29

Figure 20. Site layout for San Joaquin tower site. 31

Figure 21. Generic diagram to demonstration the relationship between tower and instrument hut when boom facing east and instrument hut on the west towards the tower. 32

Figure 22. Soaproot Saddle boundary map and NEON original candidate tower location. 34

Figure 23. Vegetative cover map of the Soaproot Saddle relocatable site and surrounding areas 36

Figure 24. Ecosystem and surrounding environment at the Soaproot Saddle relocatable site..... 38

Figure 25. Soil map of the Soaproot Saddle site and surrounding areas. 39

Figure 26. Example semivariogram, depicting range, sill, and nugget. 45

Figure 27. Spatially cyclic sampling design for the measurements of soil temperature and soil water content..... 45

Figure 28. Left graph: mobile (circles) and stationary (line) soil temperature data. Center graph: temperature data after correcting for changes in temperature in the stationary data (circles) and a linear regression based on time of day (line). Right graph: residual temperature data after correcting for changes temperature in the stationary data and the time of day regression. Data in the right graph were used for the semivariogram analysis. 46

Figure 29. Left graphs: exploratory data analysis plots for residuals of temperature. Center graph: directional semivariograms for residuals of temperature. Right graph: empirical semivariogram (circles) and model (line) fit to residuals of temperature. 47

Figure 30. Left graph: mobile (circles) and stationary (line) soil water content data. Center graph: water content data after correcting for changes in water content in the stationary data (circles) and a linear regression based on time of day (line). Right graph: residual water content data after correcting for changes water content in the stationary data and the time of day regression. Data in the right graph were used for the semivariogram analysis. 47

Figure 31. Left graphs: exploratory data analysis plots for residuals of soil water content. Center graph: directional semivariograms for residuals of water content. Right graph: empirical semivariogram (circles) and model (line) fit to residuals of water content..... 48

Figure 32. Site layout at Soaproot Saddle showing soil array and location of the FIU soil pit. 50

Figure 33. Windroses for Soaproot Saddle Relocatable site. 52

Figure 34. Soaproot Saddle Relocatable site summer daytime (convective) footprint output with max wind speed..... 55

Figure 35. Soaproot Saddle Relocatable site summer daytime (convective) footprint output with mean wind speed..... 56

Figure 36. Soaproot Saddle Relocatable site summer nighttime (stable) footprint output with mean wind speed..... 57

Figure 37. Soaproot Saddle Relocatable site winter daytime (convective) footprint output with max wind speed..... 58

Figure 38. Soaproot Saddle Relocatable site winter daytime (convective) footprint output with mean wind speed..... 59

Title: D17 FIU Site Characterization: Supporting Data	Author: Luo/ Ayres/Loescher	Date: 09/26/2011
NEON Doc. #: NEON.DOC.011077		Revision: B

Figure 39. Soaproot Saddle Relocatable site winter nighttime (stable) footprint output with mean wind speed..... 60

Figure 40. Site layout for Soaproot Relocatable site. 63

Figure 41. Generic diagram to demonstration the relationship between tower and instrument hut when boom facing north and instrument hut on the west towards the tower. 64

Figure 42. The boundary map and original Upper Teakettle candidate tower location. The tower location is now moved to Lower Teakettle site. 65

Figure 43. A map to indicate the new Lower Teakettle tower location. 66

Figure 44. Vegetative cover map of the Lower Teakettle relocatable site and surrounding areas 67

Figure 45. Mixed conifer forest is the dominated ecosystem at Lower Teakettle Relocatable site. 69

Figure 46. Soil map of the Lower Teakettle Relocatable site and surrounding areas. 70

Figure 47. Example semivariogram, depicting range, sill, and nugget. 74

Figure 48. Spatially cyclic sampling design for the measurements of soil temperature and soil water content..... 75

Figure 49. Left graph: mobile (circles) and stationary (line) soil temperature data. Center graph: temperature data after correcting for changes in temperature in the stationary data (circles) and a linear regression based on time of day (line). Right graph: residual temperature data after correcting for changes temperature in the stationary data and the time of day regression. Data in the right graph were used for the semivariogram analysis. 76

Figure 50. Left graphs: exploratory data analysis plots for residuals of temperature. Center graph: directional semivariograms for residuals of temperature. Right graph: empirical semivariogram (circles) and model (line) fit to residuals of temperature. 77

Figure 51. Left graph: mobile (circles) and stationary (line) soil water content data. Center graph: water content data after correcting for changes in water content in the stationary data (circles) and a linear regression based on time of day (line). Right graph: residual water content data after correcting for changes water content in the stationary data and the time of day regression. Data in the right graph were used for the semivariogram analysis. 77

Figure 52. Left graphs: exploratory data analysis plots for residuals of soil water content. Center graph: directional semivariograms for residuals of water content. Right graph: empirical semivariogram (circles) and model (line) fit to residuals of water content. 78

Figure 53. Site layout at Lower Teakettle showing soil array and location of the FIU soil pit..... 80

Figure 54. Windroses for Lower Teakettle relocatable site..... 82

Figure 55. Lower Teakettle Relocatable site summer daytime (convective) footprint output with max wind speed..... 85

Figure 56. Lower Teakettle Relocatable site summer daytime (convective) footprint output with mean wind speed..... 86

Figure 57. Lower Teakettle Relocatable site summer nighttime (stable) footprint output with mean wind speed..... 87

Figure 58. Lower Teakettle Relocatable site winter daytime (convective) footprint output with max wind speed..... 88

Figure 59. Lower Teakettle Relocatable site winter daytime (convective) footprint output with mean wind speed..... 89

Figure 60. Lower Teakettle Relocatable site winter nighttime (stable) footprint output with mean wind speed..... 90

Figure 61. Site layout for Lower Teakettle Relocatable site. 93

<i>Title:</i> D17 FIU Site Characterization: Supporting Data	<i>Author:</i> Luo/ Ayres/Loescher	<i>Date:</i> 09/26/2011
<i>NEON Doc. #:</i> NEON.DOC.011077		<i>Revision:</i> B

Figure 62. Generic diagram to demonstration the relationship between tower and instrument hut when boom facing west and instrument hut on the east towards the tower. 94

<i>Title:</i> D17 FIU Site Characterization: Supporting Data	<i>Author:</i> Luo/ Ayres/Loescher	<i>Date:</i> 09/26/2011
<i>NEON Doc. #:</i> NEON.DOC.011077		<i>Revision:</i> B

1 DESCRIPTION

1.1 Purpose

Data collected, analyzed and described here are used to inform the site design activities for NEON project Teams: EHS (permitting), FCC, ENG and FSU. This report was made based on actual site visits to the 3 NEON sites in Domain 17. This document presents all the supporting data for FIU site characterization at San Joaquin Experimental Range Advanced Tower site, Soaproot Saddle Relocatable site, and Lower Teakettle relocatable site (alternative for previous Upper Teakettle relocatable site).

1.2 Scope

FIU site characterization data and analysis results presented in this document are for three D17 tower locations: San Joaquin Experimental Range site (Advanced), Soaproot Saddle site (Relocatable 1) and Lower Teakettle site (relocatable 2). Issues and concerns for each site that need further review are also addressed in this document according to our best knowledge.

Disclaimer, accuracy of our latitude and longitude points are subject to the tolerances of our GPS measurement system i.e., $\sim \pm 3$ m.

Title: D17 FIU Site Characterization: Supporting Data	Author: Luo/ Ayres/Loescher	Date: 09/26/2011
NEON Doc. #: NEON.DOC.011077		Revision: B

2 RELATED DOCUMENTS AND ACRONYMS

2.1 Applicable Documents

AD[01]	NEON.DOC.011008 _ FIU Tower Design Science Requirements
AD[02]	NEON.DOC.011000 _ FIU Technical and Operation Requirements
AD[03]	
AD[04]	NEON.DOC.011029 _ FIU Precipitation Collector Site Design Requirements

2.2 Reference Documents

RD[01]	NEON.DOC.000008 NEON Acronym List
RD[02]	NEON.DOC.000243 NEON Glossary of Terms
RD[03]	
RD[04]	

2.3 Acronyms

2.4 Verb Convention

"Shall" is used whenever a specification expresses a provision that is binding. The verbs "should" and "may" express non-mandatory provisions. "Will" is used to express a declaration of purpose on the part of the design activity.

Title: D17 FIU Site Characterization: Supporting Data	Author: Luo/ Ayres/Loescher	Date: 09/26/2011
NEON Doc. #: NEON.DOC.011077		Revision: B

3 SAN JOAQUIN EXPERIMENTAL RANGE ADVANCED TOWER SITE

3.1 Site description

NEON candidate tower location at this site is located within property of San Joaquin Experimental Range (Figure 1).

The San Joaquin Experimental Range is an ecosystem research experimental area in the foothills of the Sierra Nevada. The range is located in O'Neals, California, outside of the Sierra National Forest about 32 kilometres (20 mi) north of Fresno, California. The San Joaquin Experimental Range was established after a statement on the need for an experimental area in the San Joaquin Valley foothills was prepared in 1934. The initial purpose for the San Joaquin Experimental Range was to learn how to better manage these lands. San Joaquin lands were purchased in 1934 (1,387 hectares / 3,427 acres), with additional purchases in 1936 (16 hectares / 40 acres) and 1937 (372 hectares / 919 acres). In 1938, another 64 ha were obtained under authority of the Weeks Forestry Act. Of these, 32 ha have been designated as a Research Natural Area. The San Joaquin is managed cooperatively by the Pacific Southwest Research Station and California State University's Agricultural Foundation, primarily for research and education. Facilities include limited conference facilities, office space, barracks, and storage space available for approved research. The range's administration is located at: San Joaquin Experimental Range USDA Forest Service Sierra Nevada Research Center 2081 East Sierra Avenue Fresno, CA 93710 with a research and lab located at: San Joaquin Experimental Range California State University-Fresno School of Agricultural Sciences and Technology 2385 East Barstow Avenue Fresno, CA 93740 (Info source: http://en.wikipedia.org/wiki/San_Joaquin_Experimental_Range).

Site description below is from USFS website http://www.fs.fed.us/psw/ef/san_joaquin/ :

Climate: The climate is Mediterranean, with about 486 mm of rain falling from October or November to April or May. Winters are cool and wet, with frequent frosts and monthly mean temperatures between 4 and 10 °C. Elevation ranges from 210 to 520 m above sea level, with most of the area between 300 and 457 m. Exposures are generally southwesterly. The area drains into a small tributary of the San Joaquin River. Summers are hot and dry, with maximum daily temperatures commonly exceeding 38 °C and monthly mean temperatures ranging from 24 to 27 °C.

Soils: Bedrock is mainly granitic. Soils on slopes are shallow, residual, and granitic and generally of the Ahwahnee series. Soils in swales are deeper and are alluvial and generally of the Visalia series. Slope and swale soils have a relatively low water-holding capacity. Granitic outcrops are common on slopes. More detailed description is below.

Long-Term Data Bases: Data bases maintained at San Joaquin include long-term climate information, a list of all publications based on information acquired at the forest, spring bird counts begun in the mid-1980s, long-term acorn production censuses, and grazing intensity information.

Research, Past and Present: Nearly 400 publications have emerged from work at San Joaquin covering studies on energy flow, ecosystem modeling, nutrient flow, fire ecology, geology and soils, hydrology, weather and climate, grasses, woody plants, monitoring techniques, vertebrates (especially quail and passerine birds), invertebrates, livestock breeding/growth, livestock disease/nutrition, seeding, and sulfur fertilization. Recent research addresses the following topics: geographical ecology of acorn production by California oaks; monitoring herbaceous production and utilization; effect of burning and overstory canopy on seasonal forage production and species composition; introduced annual clovers; beef sire evaluation; comparison of reproductive strategies of open- and cavity-nesting birds; methods

Title: D17 FIU Site Characterization: Supporting Data	Author: Luo/ Ayres/Loescher	Date: 09/26/2011
NEON Doc. #: NEON.DOC.011077		Revision: B

for monitoring trends in bird populations in oak-pine woodlands; interspecific competition for nest sites between european starlings and native cavity-nesting bird species; foraging ecology of European starlings; effects of Africanized honey bees on pollination by other bees; and ammonia emissions from natural soils and vegetation. Current educational activities include a variety of experiences for students with beef cow/calf production and management: in animal science, livestock and carcass evaluation, beef production, livestock and dairy evaluation, animal health, and artificial insemination and embryo transfer. Other educational activities include archaeology field classes, field day and leadership conferences to help to disseminate information generated at San Joaquin.

Major Research Accomplishments and Effects on Management: Significant contributions have been and are being made to the development of sustainable grazing systems in California's oak woodland savannas. The nearly 20-year long record of bird counts is an extraordinary resource for exploring the year-to-year variation of bird populations and diversity in oak woodland savannas.

Collaborators: Collaborating scientists from Fresno Agricultural Foundation, California State University-Fresno, University of California at Davis and at Berkeley, and Fresno City College engage in cooperative research at San Joaquin as do university extension, and cooperative extension groups from these same institutions.

Research Opportunities: Livestock are continuously present at San Joaquin and can be used in experiments to evaluate the relations among livestock, grazing effects, and plants and other animals. Ecosystem responses to prescribed fire in foothill oak woodlands can also be studied.

Title: D17 FIU Site Characterization: Supporting Data	Author: Luo/ Ayres/Loescher	Date: 09/26/2011
NEON Doc. #: NEON.DOC.011077		Revision: B

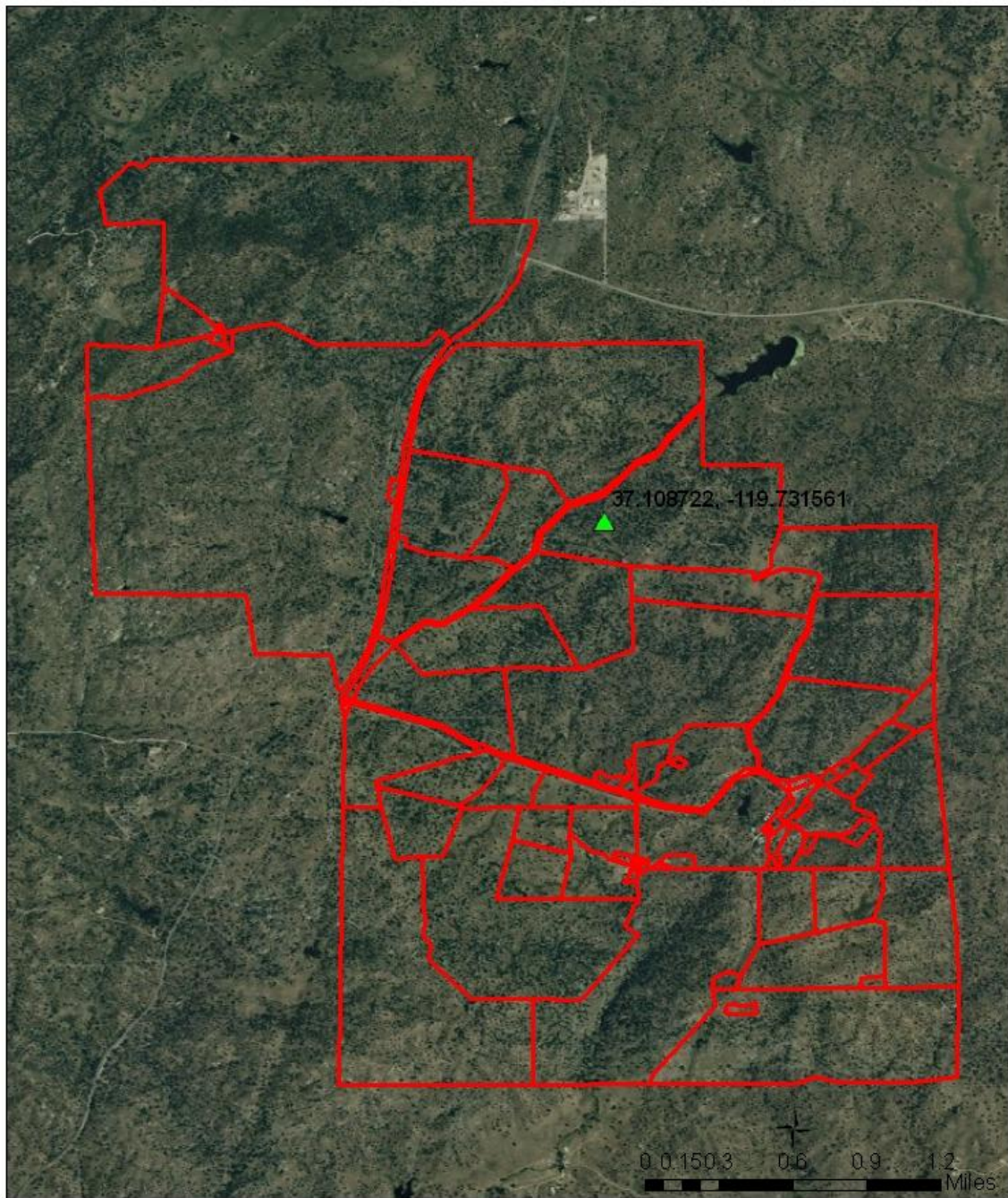

**Domain 17 - San Joaquin
Experimental Range**

- ▲ NEON Candidate Location
- San Joaquin Property Boundary

Figure 1. Boundary map for San Joaquin Site and original candidate tower location.

Title: D17 FIU Site Characterization: Supporting Data	Author: Luo/ Ayres/Loescher	Date: 09/26/2011
NEON Doc. #: NEON.DOC.011077		Revision: B

3.2 Ecosystem

San Joaquin contains open woodland dominated by oaks (blue and interior live oaks) and California Foothills pine (*pinus sabiniana*) with scattered shrubs and nearly continuous cover of herbaceous plants. Swales occur in low areas between rises. Dominant shrub species include ceanothus (both wedgeleaf ceanothus and chaparral whitehorn) and manzanita. Herbaceous plants are generally annuals including grasses (e.g., pine bluegrass soft chess, foxtail fescue), and various legumes. Perennials, primarily rushes, are found in the bottomlands. Native perennial bunchgrasses are uncommon and occur on north slopes (info source: http://www.fs.fed.us/psw/ef/san_joaquin/).

Vegetation and land cover information at surrounding region are presented below:

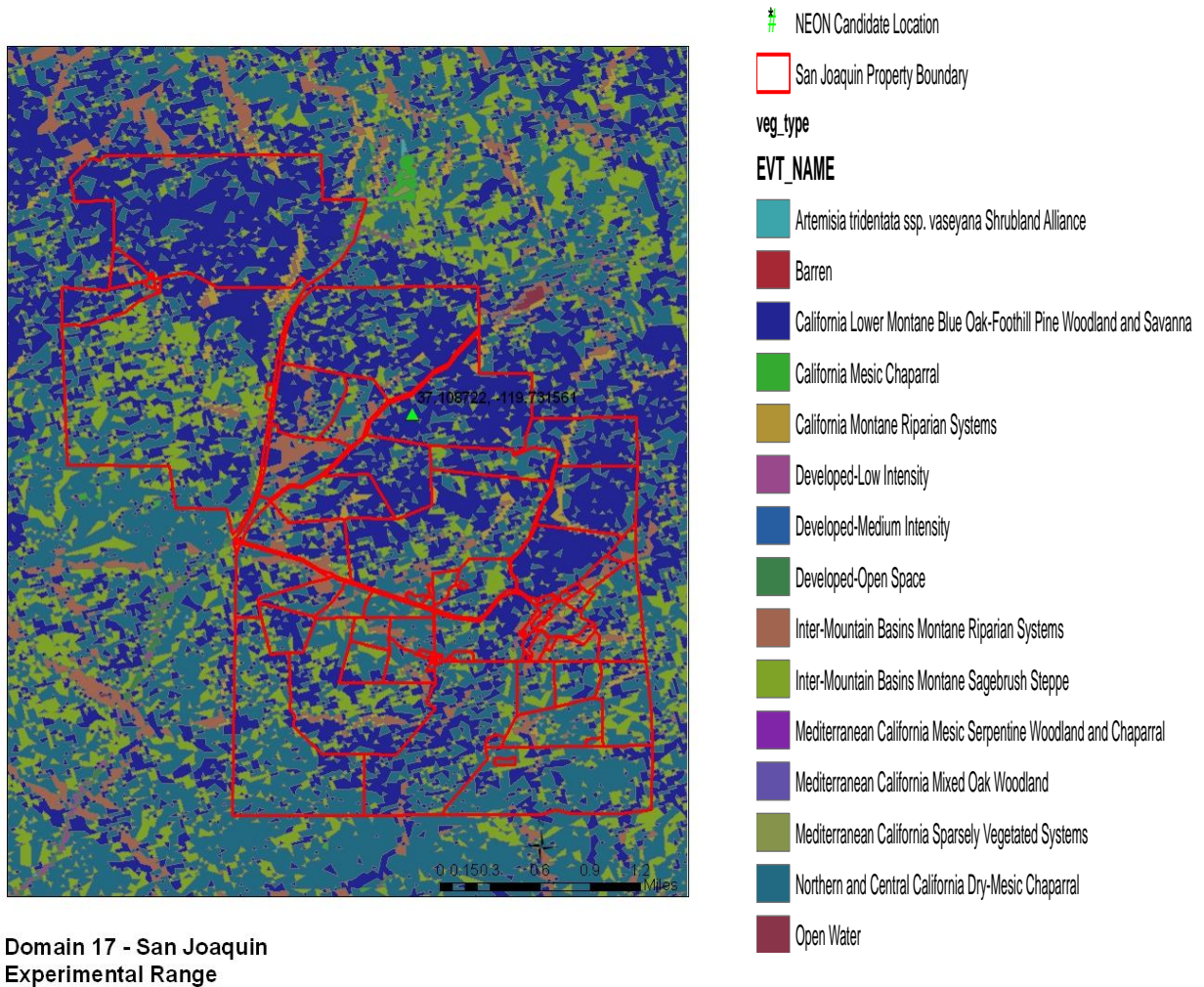

Figure 2. Vegetative cover map of San Joaquin site and surrounding areas (information is from USGS, <http://landfire.cr.usgs.gov/viewer/viewer.htm>).

Table 1. Percent Land cover type at San Joaquin site

Title: D17 FIU Site Characterization: Supporting Data	Author: Luo/ Ayres/Loescher	Date: 09/26/2011
NEON Doc. #: NEON.DOC.011077		Revision: B

(information is from USGS, <http://landfire.cr.usgs.gov/viewer/viewer.htm>)

Vegetation Type	Area (km ²)	Percentage
Developed-Open Space	0.07	0.39
Developed-Low Intensity	0.02	0.10
Mediterranean California Sparsely Vegetated Systems	0.00	0.00
Mediterranean California Mesic Serpentine Woodland and Chaparral	0.00	0.01
California Mesic Chaparral	0.02	0.11
Northern and Central California Dry-Mesic Chaparral	5.71	31.35
California Lower Montane Blue Oak-Foothill Pine Woodland and Savanna	8.40	46.16
Inter-Mountain Basins Montane Sagebrush Steppe	2.86	15.73
California Montane Riparian Systems	0.39	2.13
Inter-Mountain Basins Montane Riparian Systems	0.72	3.95
Artemisia tridentata ssp. vaseyana Shrubland Alliance	0.01	0.06
Total Area Sq Km	18.21	100.00

The ecosystem around tower and within the airshed at this site is oak woodland savanna, which also mixes with some California Foothills pine trees. Oak is dominant by blue oaks. Tree canopy is very open. Tree overstory coverage counts for ~ 40% with ~2/3 for oak and 1/3 for pine. The tree density is ~ 60 ha⁻¹. The canopy height is ~ 21 m for pine trees with lowest branch at 4.5 m, and canopy height ~ 12 m for oaks with the lowest branch at ~1.1 m above ground. Hawthorn and other shrubs form top understory with height ~ 5 m and scatter in Savanna. Herbaceous plants, generally annuals including grasses (e.g., pine bluegrass soft chess, foxtail fescue), form the understory at ground level and carpet on the floor. Grass height is ~ 0.6 m without the central stems and ~1.1 m with the central stems. LAI is approximately 1.7 for tree and about 1.7 for grass. The rainy season at this site is from October to next February. High productivity season is March to May for grass, and is May to October for trees. Micro scale topography is less than 10 ha², which is dominant by small hills and swales. Hills have length ~ 100 m, width ~ 50 m, and ~ 100 m from one to another. Topography is punctuated by large rock outcrops, which count for ~8-10% landscape coverage.



Figure 3 Oak Savanna is the dominant vegetation type at San Joaquin site

Title: D17 FIU Site Characterization: Supporting Data	Author: Luo/ Ayres/Loescher	Date: 09/26/2011
NEON Doc. #: NEON.DOC.011077		Revision: B

Table 2. Ecosystem and site attributes for San Joaquin tower site.

Ecosystem attributes	Measure and units
Mean canopy height*	21 m
Surface roughness ^a	3 m
Zero place displacement height ^a	16 m
Structural elements	Oak-pine Savanna
Time zone	Pacific time zone
Magnetic declination	13° 39' E changing by 0° 6' W/year

Note, ^a From field observation. *Although blue oak is dominant tree species at this site, pine trees are taller and have larger impacts on air flow dynamics at canopy surface layer. Therefore, pine tree height is used here for the purpose of tower design.

3.3 Soils

According to the observation at San Joaquin, Soil is clay, very shallow with parent material close to ground. Soil depth is ~ 30 cm to 1 m.

3.3.1 Soil description

Soil data and soil maps below for San Joaquin tower site were collected from 7.9 km² NRCS soil maps(<http://websoilsurvey.nrcs.usda.gov/app/HomePage.htm>) to determine the dominant soil types in the larger tower foot print. This was done to assure that the soil array is in the dominant (or in the co-dominant) soil type present in the tower footprint.

Title: D17 FIU Site Characterization: Supporting Data	Author: Luo/ Ayres/Loescher	Date: 09/26/2011
NEON Doc. #: NEON.DOC.011077		Revision: B

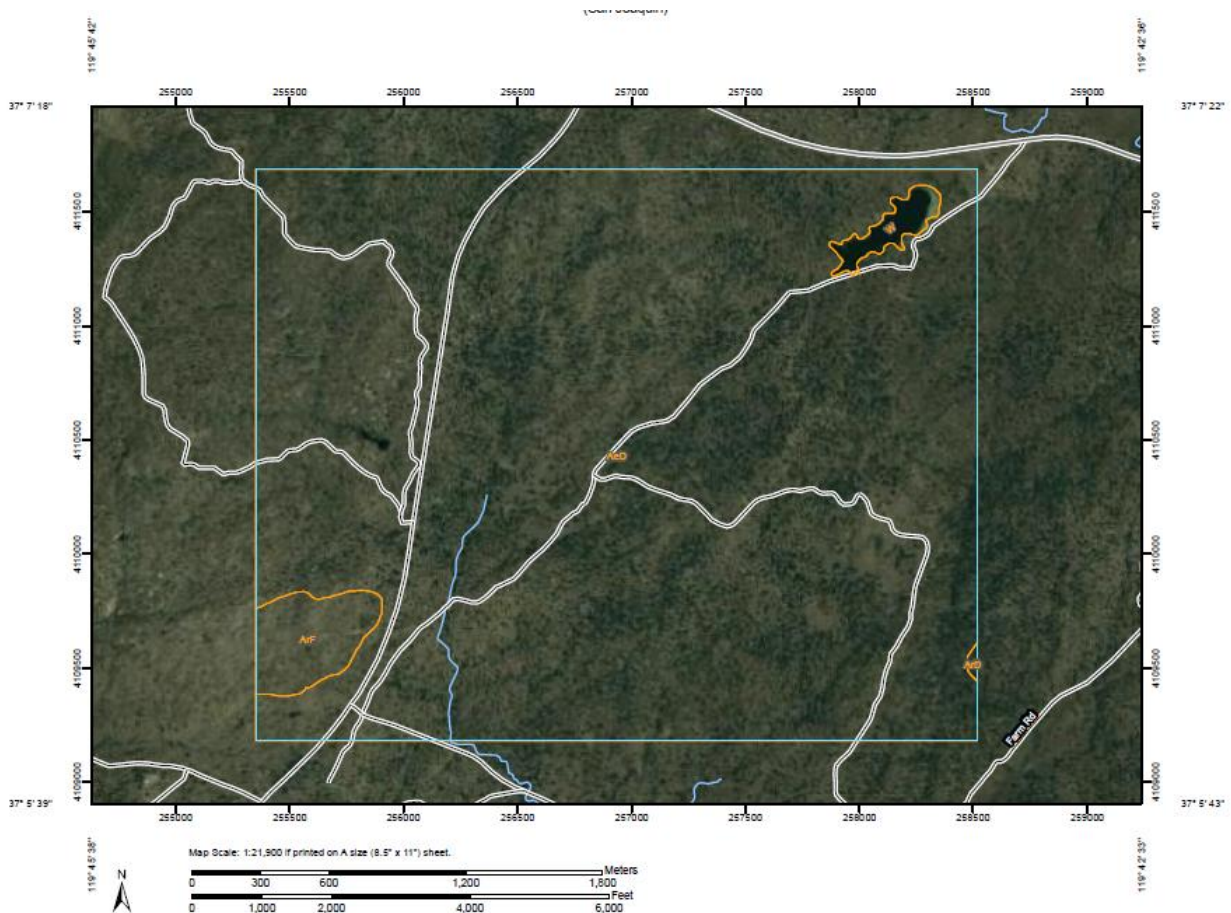

Figure 4. Soil map for San Joaquin NEON advanced tower site.

Map Unit Description The map units delineated on the detailed soil maps in a soil survey represent the soils or miscellaneous areas in the survey area. The map unit descriptions in this report, along with the maps, can be used to determine the composition and properties of a unit. A map unit delineation on a soil map represents an area dominated by one or more major kinds of soil or miscellaneous areas. A map unit is identified and named according to the taxonomic classification of the dominant soils. Within a taxonomic class there are precisely defined limits for the properties of the soils. On the landscape, however, they have the characteristic variability of all natural phenomena. Thus, the range of some observed properties may extend beyond the limits defined for a taxonomic class. Areas of soils of a single taxonomic class rarely, if ever, can be mapped without including areas of other taxonomic classes. Consequently, every map unit is made up of the soils or miscellaneous areas for which it is named and some minor components that belong to taxonomic classes other than those of the major soils. Most minor soils have properties similar to those of the dominant soil or soils in the map unit, and thus they do not affect use and management. These are called non-contrasting, or similar, components. They may or may not be mentioned in a particular map unit description. Other minor components, however, have properties and behavioral characteristics divergent enough to affect use or to require different management. These are called contrasting, or dissimilar, components. They generally are in small areas and could not be mapped separately because of the scale used. Some small areas of strongly contrasting soil types or miscellaneous areas are identified by a special symbol on the maps. If included

Title: D17 FIU Site Characterization: Supporting Data	Author: Luo/ Ayres/Loescher	Date: 09/26/2011
NEON Doc. #: NEON.DOC.011077		Revision: B

in the database for a given area, the contrasting minor components are identified in the map unit descriptions along with some characteristics of each. A few areas of minor components may not have been observed, and consequently they are not mentioned in the descriptions, especially where the pattern was so complex that it was impractical to make enough observations to identify all the soils and miscellaneous areas on the landscape. The presence of minor components in a map unit in no way diminishes the usefulness or accuracy of the data. The objective of mapping is not to delineate pure taxonomic classes but rather to separate the landscape into landforms or landform segments that have similar use and management requirements. The delineation of such segments on the map provides sufficient information for the development of resource plans. If intensive use of small areas is planned, however, onsite investigation is needed to define and locate the soils and miscellaneous areas. An identifying symbol precedes the map unit name in the map unit descriptions. Each description includes general facts about the unit and gives important soil properties and qualities.

Soils that have profiles that are almost alike make up a soil series. All the soils of a series have major horizons that are similar in composition, thickness, and arrangement. Soils of a given series can differ in texture of the surface layer, slope, stoniness, salinity, degree of erosion, and other characteristics that affect their use. On the basis of such differences, a soil series is divided into soil phases. Most of the areas shown on the detailed soil maps are phases of soil series. The name of a soil phase commonly indicates a feature that affects use or management. For example, Alpha silt loam, 0 to 2 percent slopes, is a phase of the Alpha series. Some map units are made up of two or more major soils or miscellaneous areas. These map units are complexes, associations, or undifferentiated groups. A complex consists of two or more soils or miscellaneous areas in such an intricate pattern or in such small areas that they cannot be shown separately on the maps. The pattern and proportion of the soils or miscellaneous areas are somewhat similar in all areas. Alpha-Beta complex, 0 to 6 percent slopes, is an example. An association is made up of two or more geographically associated soils or miscellaneous areas that are shown as one unit on the maps. Because of present or anticipated uses of the map units in the survey area, it was not considered practical or necessary to map the soils or miscellaneous areas separately. The pattern and relative proportion of the soils or miscellaneous areas are somewhat similar. Alpha-Beta association, 0 to 2 percent slopes, is an example. An undifferentiated group is made up of two or more soils or miscellaneous areas that could be mapped individually but are mapped as one unit because similar interpretations can be made for use and management. The pattern and proportion of the soils or miscellaneous areas in a mapped area are not uniform. An area can be made up of only one of the major soils or miscellaneous areas, or it can be made up of all of them. Alpha and Beta soils, 0 to 2 percent slopes, is an example. Some surveys include miscellaneous areas. Such areas have little or no soil material and support little or no vegetation. Rock outcrop is an example. Additional information about the map units described in this report is available in other soil reports, which give properties of the soils and the limitations, capabilities, and potentials for many uses. Also, the narratives that accompany the soil reports define some of the properties included in the map unit descriptions.

Table 3. Soil Series and percentage of soil series within 7.9 km² around the tower. Area Object Interest (AOI) is the mapping unit from NRCS.

Title: D17 FIU Site Characterization: Supporting Data	Author: Luo/ Ayres/Loescher	Date: 09/26/2011
NEON Doc. #: NEON.DOC.011077		Revision: B

Madera Area, California (CA651)			
Map Unit Symbol	Map Unit Name	Acres in AOI	Percent of AOI
AeD	Ahwahnee and Vista rocky coarse sandy loams, 8 to 30 percent slopes	1,893.3	96.7%
ArD	Ahwahnee and Vista very rocky coarse sandy loams, 15 to 30 percent slopes	1.3	0.1%
ArF	Ahwahnee and Vista very rocky coarse sandy loams, 30 to 75 percent slopes	47.0	2.4%
W	Water	16.9	0.9%
Totals for Area of Interest		1,958.5	100.0%

Madera Area, California AeD—Ahwahnee and Vista rocky coarse sandy loams, 8 to 30 percent slopes:
Map Unit Setting Elevation: 200 to 3,900 feet Mean annual precipitation: 10 to 25 inches Mean annual air temperature: 59 to 64 degrees F Frost-free period: 175 to 300 days **Map Unit Composition** Vista and similar soils: 35 percent Ahwahnee and similar soils: 35 percent Minor components: 30 percent
Description of Ahwahnee Setting Landform: Mountain slopes Landform position (two-dimensional): Backslope Landform position (three-dimensional): Mountainflank Down-slope shape: Convex Across-slope shape: Linear Parent material: Residuum weathered from granite **Properties and qualities** Slope: 8 to 30 percent Depth to restrictive feature: 48 to 52 inches to paralithic bedrock Drainage class: Well drained Capacity of the most limiting layer to transmit water (Ksat): Very low to moderately low (0.00 to 0.06 in/hr) Depth to water table: More than 80 inches Frequency of flooding: None Frequency of ponding: None Available water capacity: Low (about 5.3 inches) **Interpretive groups** Land capability (nonirrigated): 6e **Typical profile** 0 to 8 inches: Coarse sandy loam 8 to 48 inches: Sandy loam 48 to 52 inches: Weathered bedrock **Description of Vista Setting** Landform: Mountain slopes Landform position (two-dimensional): Foothlope Landform position (three-dimensional): Mountainflank Down-slope shape: Concave Across-slope shape: Linear Parent material: Residuum weathered from granite **Properties and qualities** Slope: 8 to 30 percent Depth to restrictive feature: 36 to 40 inches to paralithic bedrock Drainage class: Well drained Capacity of the most limiting layer to transmit water (Ksat): Very low to moderately low (0.00 to 0.06 in/hr) Depth to water table: More than 80 inches Frequency of flooding: None Frequency of ponding: None Available water capacity: Low (about 3.6 inches) **Interpretive groups** Land capability (nonirrigated): 6e **Typical profile** 0 to 12 inches: Coarse sandy loam 12 to 36 inches: Coarse sandy loam 36 to 40 inches: Weathered bedrock **Minor Components** **Tollhouse** Percent of map unit: 10 percent **Coarsegold** Percent of map unit: 10 percent **Auberry** Percent of map unit: 10 percent

Madera Area, California ArD—Ahwahnee and Vista very rocky coarse sandy loams, 15 to 30 percent slopes
Map Unit Setting Elevation: 200 to 3,900 feet Mean annual precipitation: 10 to 25 inches Mean annual air temperature: 59 to 64 degrees F Frost-free period: 175 to 300 days **Map Unit Composition** Vista and similar soils: 25 percent Ahwahnee and similar soils: 25 percent Rock outcrop: 20 percent Minor components: 30 percent **Description of Ahwahnee Setting** Landform: Mountain slopes Landform position (two-dimensional): Backslope Landform position (three-dimensional): Mountainflank Down-slope shape: Convex Across-slope shape: Linear Parent material: Residuum weathered from granite **Properties and qualities** Slope: 15 to 30 percent Depth to restrictive feature: 36 to 40 inches to paralithic bedrock Drainage class: Well drained Capacity of the most limiting layer to transmit water

Title: D17 FIU Site Characterization: Supporting Data	Author: Luo/ Ayres/Loescher	Date: 09/26/2011
NEON Doc. #: NEON.DOC.011077		Revision: B

(Ksat): Very low to moderately low (0.00 to 0.06 in/hr) Depth to water table: More than 80 inches
 Frequency of flooding: None Frequency of ponding: None Available water capacity: Low (about 3.9 inches) **Interpretive groups** Land capability (nonirrigated): 7e **Typical profile** 0 to 8 inches: Coarse sandy loam 8 to 36 inches: Sandy loam 36 to 40 inches: Weathered bedrock **Description of Vista Setting**
 Landform: Mountain slopes Landform position (two-dimensional): Footslope Landform position (three-dimensional): Mountainflank Down-slope shape: Concave Across-slope shape: Linear Parent material: Residuum weathered from granite **Properties and qualities** Slope: 15 to 30 percent Depth to restrictive feature: 36 to 40 inches to paralithic bedrock Drainage class: Well drained Capacity of the most limiting layer to transmit water (Ksat): Very low to moderately low (0.00 to 0.06 in/hr) Depth to water table: More than 80 inches Frequency of flooding: None Frequency of ponding: None Available water capacity: Low (about 3.6 inches) **Interpretive groups** Land capability (nonirrigated): 7e **Typical profile** 0 to 12 inches: Coarse sandy loam 12 to 36 inches: Coarse sandy loam 36 to 40 inches: Weathered bedrock **Description of Rock Outcrop Properties and qualities** Slope: 15 to 30 percent Depth to restrictive feature: 0 to 4 inches to lithic bedrock Drainage class: Excessively drained Capacity of the most limiting layer to transmit water (Ksat): Very low (0.00 in/hr) **Interpretive groups** Land capability (nonirrigated): 8 **Typical profile** 0 to 4 inches: Unweathered bedrock **Minor Components Tollhouse** Percent of map unit: 10 percent **Coarsegold** Percent of map unit: 10 percent **Auberry** Percent of map unit: 10 percent

Madera Area, California ArF—Ahwahnee and Vista very rocky coarse sandy loams, 30 to 75 percent slopes Map Unit Setting Elevation: 200 to 3,900 feet Mean annual precipitation: 10 to 25 inches Mean annual air temperature: 59 to 64 degrees F Frost-free period: 175 to 300 days **Map Unit Composition** Vista and similar soils: 25 percent Ahwahnee and similar soils: 25 percent Rock outcrop: 20 percent Minor components: 30 percent **Description of Ahwahnee Setting** Landform: Mountain slopes Landform position (two-dimensional): Backslope Landform position (three-dimensional): Mountainflank Down-slope shape: Convex Across-slope shape: Linear Parent material: Residuum weathered from granite **Properties and qualities** Slope: 30 to 75 percent Depth to restrictive feature: 36 to 40 inches to paralithic bedrock Drainage class: Well drained Capacity of the most limiting layer to transmit water (Ksat): Very low to moderately low (0.00 to 0.06 in/hr) Depth to water table: More than 80 inches Frequency of flooding: None Frequency of ponding: None Available water capacity: Low (about 3.9 inches) **Interpretive groups** Land capability (nonirrigated): 7e **Typical profile** 0 to 8 inches: Coarse sandy loam 8 to 36 inches: Sandy loam 36 to 40 inches: Weathered bedrock **Description of Vista Setting** Landform: Mountain slopes Landform position (two-dimensional): Footslope Landform position (three-dimensional): Mountainflank Down-slope shape: Concave Across-slope shape: Linear Parent material: Residuum weathered from granite **Properties and qualities** Slope: 30 to 75 percent Depth to restrictive feature: 36 to 40 inches to paralithic bedrock Drainage class: Well drained Capacity of the most limiting layer to transmit water (Ksat): Very low to moderately low (0.00 to 0.06 in/hr) Depth to water table: More than 80 inches Frequency of flooding: None Frequency of ponding: None Available water capacity: Low (about 3.6 inches) **Interpretive groups** Land capability (nonirrigated): 7e **Typical profile** 0 to 12 inches: Coarse sandy loam 12 to 36 inches: Coarse sandy loam 36 to 40 inches: Weathered bedrock **Description of Rock Outcrop Properties and qualities** Slope: 30 to 75 percent Depth to restrictive feature: 0 to 4 inches to lithic bedrock Drainage class: Excessively drained Capacity of the most limiting layer to transmit water (Ksat): Very low (0.00 in/hr) **Interpretive groups** Land capability (nonirrigated): 8 **Typical profile** 0 to 4 inches: Unweathered bedrock **Minor Components Tollhouse** Percent of map unit: 10 percent **Coarsegold** Percent of map unit: 10 percent **Auberry** Percent of map unit: 10 percent

Madera Area, California W—Water Map Unit Composition Water: 100 percent

Title: D17 FIU Site Characterization: Supporting Data	Author: Luo/ Ayres/Loescher	Date: 09/26/2011
NEON Doc. #: NEON.DOC.011077		Revision: B

3.3.2 Soil semi-variogram description

The goal of this aspect of the site characterization is to determine the minimum distance between the soil plots in the soil array such that data farther apart can be considered spatially independent. The collected field data will be used to produce semivariograms, which is a geostatistical technique to characterize spatial autocorrelation between mapped samples of a quantitative variable (*e.g.*, soil property data in our case). In an empirical semivariogram, the average of the squared differences of a response variable is computed for all pairs of points within specified distance intervals (lag classes). The output is presented graphically as a plot of the average semi-variance versus distance class (Figure 5). For the theoretical variogram models considered here, the semivariance will converge on the total variance at distances for which values are no longer spatially auto-correlated (this is referred to as the range, Figure 5).

For the theoretical variograms considered here, three parameters estimated from the data are used to fit a semivariogram model to the empirical semivariogram. This model is then assumed to quantitatively represent the correlation as a function of distance (Figure 5), the range, the sill (the sill is the asymptotic value of semi-variance at the range), and the nugget (which describes sampling error or variation at distances below those separating the closest pairs of samples). The range, sill and nugget are estimated from theoretical models that are fitted to the empirical variograms using non-linear least squares methods.

The variogram analysis will be used, to determine the spatial scales at which we can consider soil measurements spatially independent. This characterization will directly inform the minimum distance between *i)* soil plots within each soil array, *ii)* the soil profile measurements, *iii)* EP plots, and *iv)* the microbial sampling locations. These data will directly inform NEON construction and site design activities.

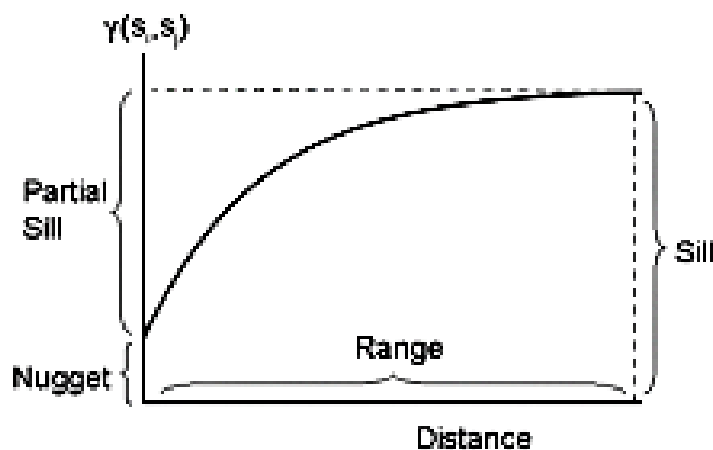

Figure 5. Example semivariogram, depicting range, sill, and nugget.

Title: D17 FIU Site Characterization: Supporting Data	Author: Luo/ Ayres/Loescher	Date: 09/26/2011
NEON Doc. #: NEON.DOC.011077		Revision: B

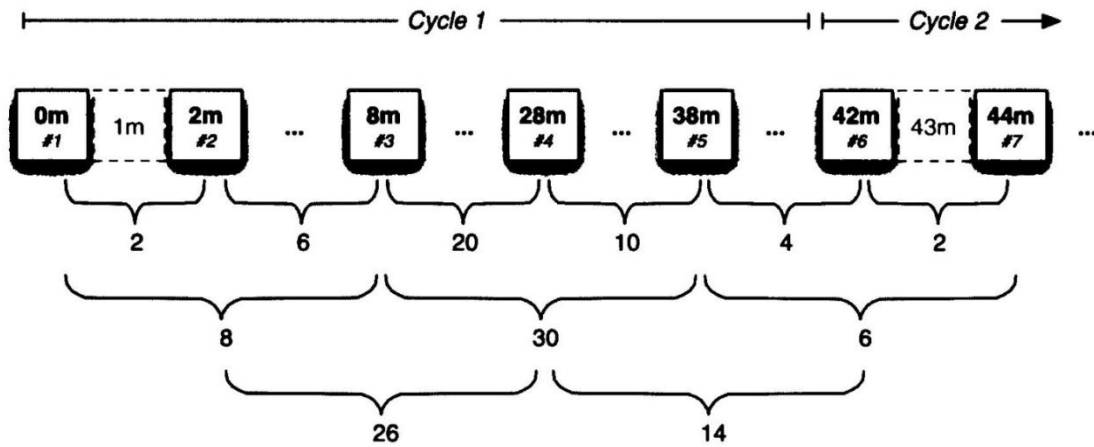

Figure 6. Spatially cyclic sampling design for the measurements of soil temperature and soil water content.

Field measurements of soil temperature (0-12 cm) and moisture (0-15 cm) were taken on 22 February 2011 at the San Joaquin site. The sampling points followed the spatially cyclic sampling design by Bond-Lamberty et al. (2006) (Figure 6). Soil temperature and moisture measurements were collected along three transects (210 m, 84 m, and 84 m) located in the expected airshed at San Joaquin. Details of how the airshed was determined are provided below. Soil temperature was measured with platinum resistance temperature sensors (RTD 810, Omega Engineering Inc., Stamford CT) and soil moisture was measured with time domain dielectric sensors (CS616, Campbell Scientific Inc., Logan UT).

As well as measuring soil temperature and moisture at each sample point in Figure 6, measurements were also taken 30 cm in front and behind the sampling point along the axis of the transect. For example, at the 2 m sampling point, soil temperature and moisture was measured at 1.7 m, 2 m, and 2.3 m; this data is referred to as mobile data, since the measurements were taken at many different locations. In addition, soil temperature and moisture were continuously recorded at a single fixed location (stationary data) throughout the sampling time to correct for changes in temperature and moisture throughout the day.

Data collected were used for geospatial analyses of variograms in the R statistical computing language with the geoR package to test for spatial autocorrelation (Trangmar *et al.* 1986; Webster & Oliver 1989; Goovaerts 1997; Riberiro & Diggle 2001) and estimate the distance necessary for independence among soil plots in the soil array. To correct for changes in temperature and moisture over the sampling period, the stationary data was subtracted from the mobile data. In many instances a time of day trend was still apparent in the data even after subtracting the stationary data from the mobile data. This time of day trend was corrected for by fitting a linear regression and using the residuals for the semivariogram analysis. Soil temperature and moisture data, R code, graphs, and R output can be found at: P:\FIU\FIU_Site_Characterization\DXX\YYYYYYY_Characterization\Soil Measurements\Soil Data Analysis (where XX = domain number and YYYYYYY = site name).

3.3.3 Results and interpretation

3.3.3.1 Soil Temperature

Soil temperature data residuals, after accounting for changes in temperature in the stationary data, any remaining time of day trend, and elevation, aspect and slope trends, were used for the semivariogram analysis (Figure 7). Exploratory data analysis plots show that there was no distinct patterning of the residuals (Figure 8, left graph) and directional semivariograms do not show anisotropy (Figure 8, center graph). An isotropic empirical semivariogram was produced and a spherical model was fitted using Cressie weights (Figure 8, right graph). The model indicates a distance of effective independence of 6 m for soil temperature.

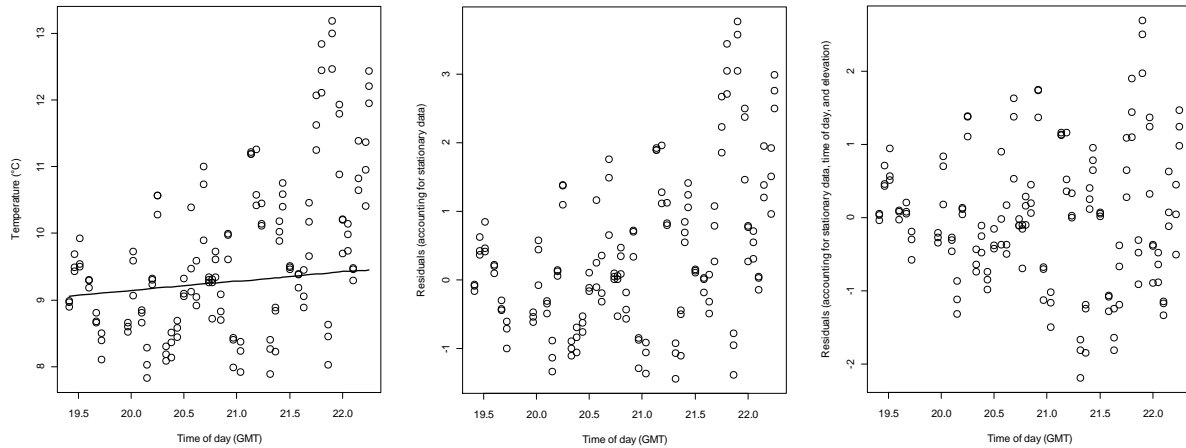

Figure 7. Left graph: mobile (circles) and stationary (line) soil temperature data. Center graph: temperature data after correcting for changes in temperature in the stationary data (circles) and a linear regression based on time of day (line). Right graph: residual temperature data after correcting for changes temperature in the stationary data and the time of day regression. Data in the right graph were used for the semivariogram analysis.

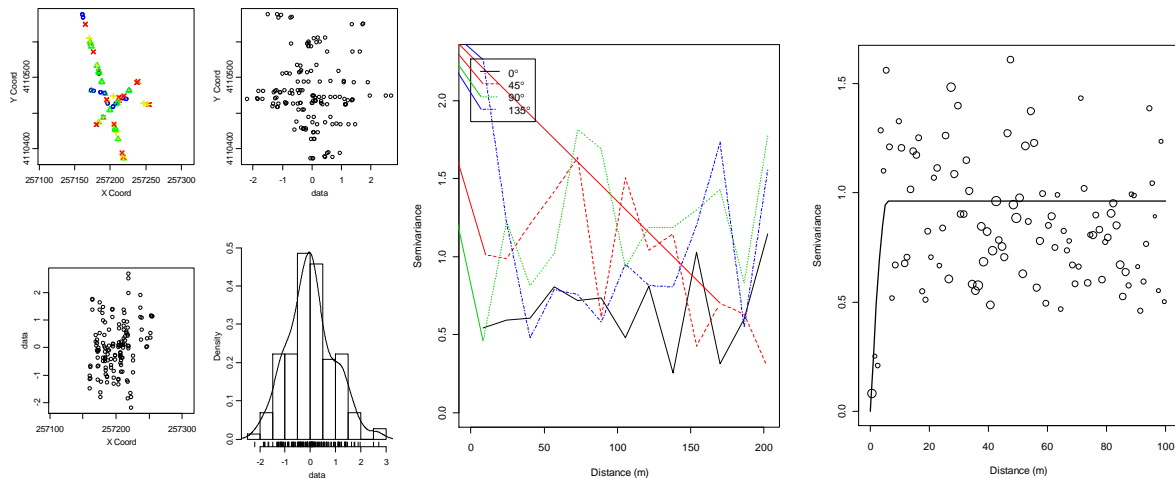

Figure 8. Left graphs: exploratory data analysis plots for residuals of temperature. Center graph: directional semivariograms for residuals of temperature. Right graph: empirical semivariogram (circles) and model (line) fit to residuals of temperature.

3.3.3.2 Soil water content

Soil water content data residuals, after accounting for changes in water content in the stationary data, any remaining time of day trend, and elevation, aspect and slope trends, were used for the semivariogram analysis (Figure 9). Exploratory data analysis plots show that there was no distinct patterning of the residuals (Figure 10, left graph) and directional semivariograms do not show anisotropy (Figure 10, center graph). An isotropic empirical semivariogram was produced and a spherical model was fitted using Cressie weights (Figure 10, right graph). The model indicates a distance of effective independence of 8 m for soil water content.

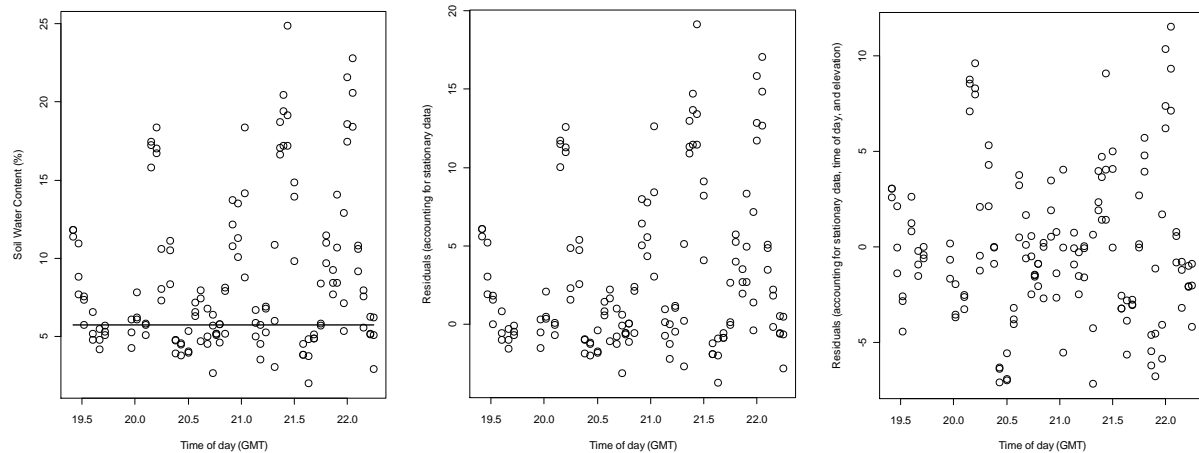

Figure 9. Left graph: mobile (circles) and stationary (line) soil water content data. Center graph: water content data after correcting for changes in water content in the stationary data (circles) and a linear regression based on time of day (line). Right graph: residual water content data after correcting for changes water content in the stationary data and the time of day regression. Data in the right graph were used for the semivariogram analysis.

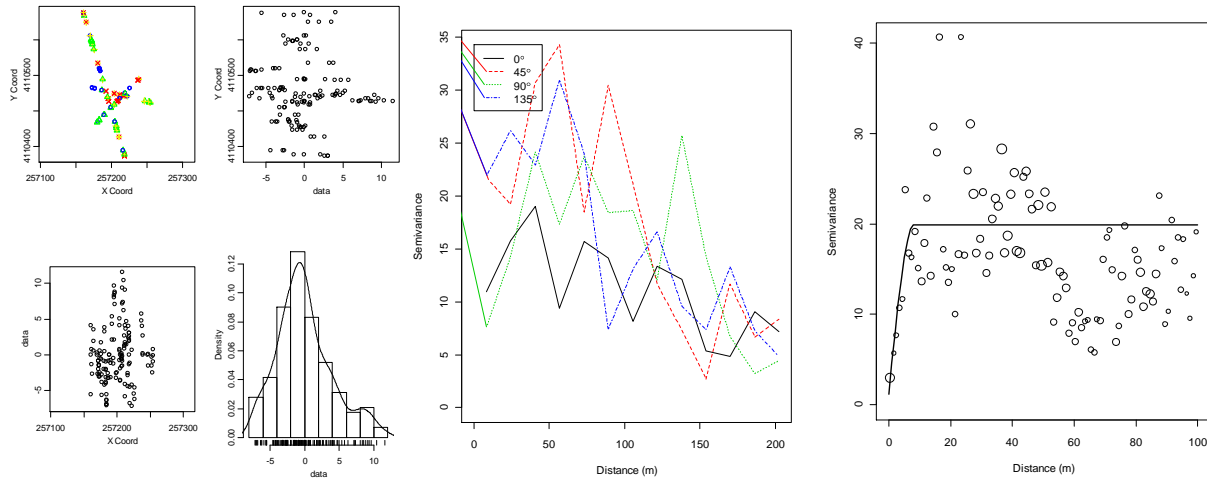

Figure 10. Left graphs: exploratory data analysis plots for residuals of soil water content. Center graph: directional semivariograms for residuals of water content. Right graph: empirical semivariogram (circles) and model (line) fit to residuals of water content.

3.3.3.3 Soil array layout and soil pit location

The minimum distance allowable between soil plots is 25 m to ensure a degree of spatial independence in non-measured soil parameters (i.e., other than temperature and water content) and the maximum distance allowable between soil plots is 40 m due to cost constraints. The estimated distance of effective independence was 6 m for soil temperature and 8 m for soil moisture. Based on these results and the site design guidelines the soil plots at San Joaquin shall be placed 25 m apart. The soil array shall follow the linear soil array design (Soil Array Pattern B) with the soil plots being 5 m x 5 m. The direction of the soil array shall be 350° from the soil plot nearest the tower (i.e., first soil plot). The location of the first soil plot will be approximately 37.108958°, -119.732319°. The exact location of each soil plot may be microsited to avoid placing a soil plot at an unrepresentative location (e.g., rock outcrop, drainage channel, large tree, etc). The FIU soil pit for characterizing soil horizon depths, collecting soil for site-specific sensor calibration, and collecting soil for the FIU soil archive will be located at 37.107923°, -119.735042° (primary location); or 37.107867°, -119.735881° (alternate location 1 if primary location is unsuitable); or 37.107860°, -119.734521° (alternate location 2 if primary location is unsuitable). A summary of the soil information is shown in Table 4 and site layout can be seen in Figure 11.

Dominant soil series at the site: Ahwahnee and Vista rocky coarse sandy loams, 8 to 30 percent slopes. The taxonomy of this soil is shown below:

Order: Alfisols-Inceptisols

Suborder: Xeralfs-Xerepts

Great group: Haploxeralfs- Haploxerepts

Subgroup: Mollic Haploxeralfs-Typic Haploxerepts

Family: Coarse-loamy, mixed, active, thermic Mollic Haploxeralfs-Coarse-loamy, mixed, superactive, thermic Typic Haploxerepts

Series: Ahwahnee and Vista rocky coarse sandy loams, 8 to 30 percent slopes

Title: D17 FIU Site Characterization: Supporting Data	Author: Luo/ Ayres/Loescher	Date: 09/26/2011
NEON Doc. #: NEON.DOC.011077		Revision: B

Table 4. Summary of soil array and soil pit information at San Joaquin. 0° represents true north and accounts for declination.

Soil plot dimensions	5 m x 5 m
Soil array pattern	B
Distance between soil plots: x	25 m
Distance from tower to closest soil plot: y	20 m
Latitude and longitude of 1 st soil plot OR direction from tower	37.108958°, -119.732319°
Direction of soil array	350°
Latitude and longitude of FIU soil pit 1	37.107923°, -119.735042° (primary location)
Latitude and longitude of FIU soil pit 2	37.107867°, -119.735881° (alternate 1)
Latitude and longitude of FIU soil pit 3	37.107860°, -119.734521° (alternate 2)
Dominant soil type	Ahwahnee and Vista rocky coarse sandy loams, 8 to 30 percent slopes
Expected soil depth	0.91 to 1.32 m
Depth to water table	>2 m
Expected depth of soil horizons	Expected measurement depths*
0-0.20 m (Coarse sandy loam)	0.10 m [†]
0.20-1.22 m (Sandy loam)	0.71 m [†]
1.22-1.32 m (Weathered bedrock)	1.27 m [†]
1.32 m	1.32 m

* Actual soil measurement depths will be determined based on measured soil horizon depths at the NEON FIU soil pit and may differ substantially from those shown here.

[†]Expected soil CO₂ sensor depths

Title: D17 FIU Site Characterization: Supporting Data	Author: Luo/ Ayres/Loescher	Date: 09/26/2011
NEON Doc. #: NEON.DOC.011077		Revision: B

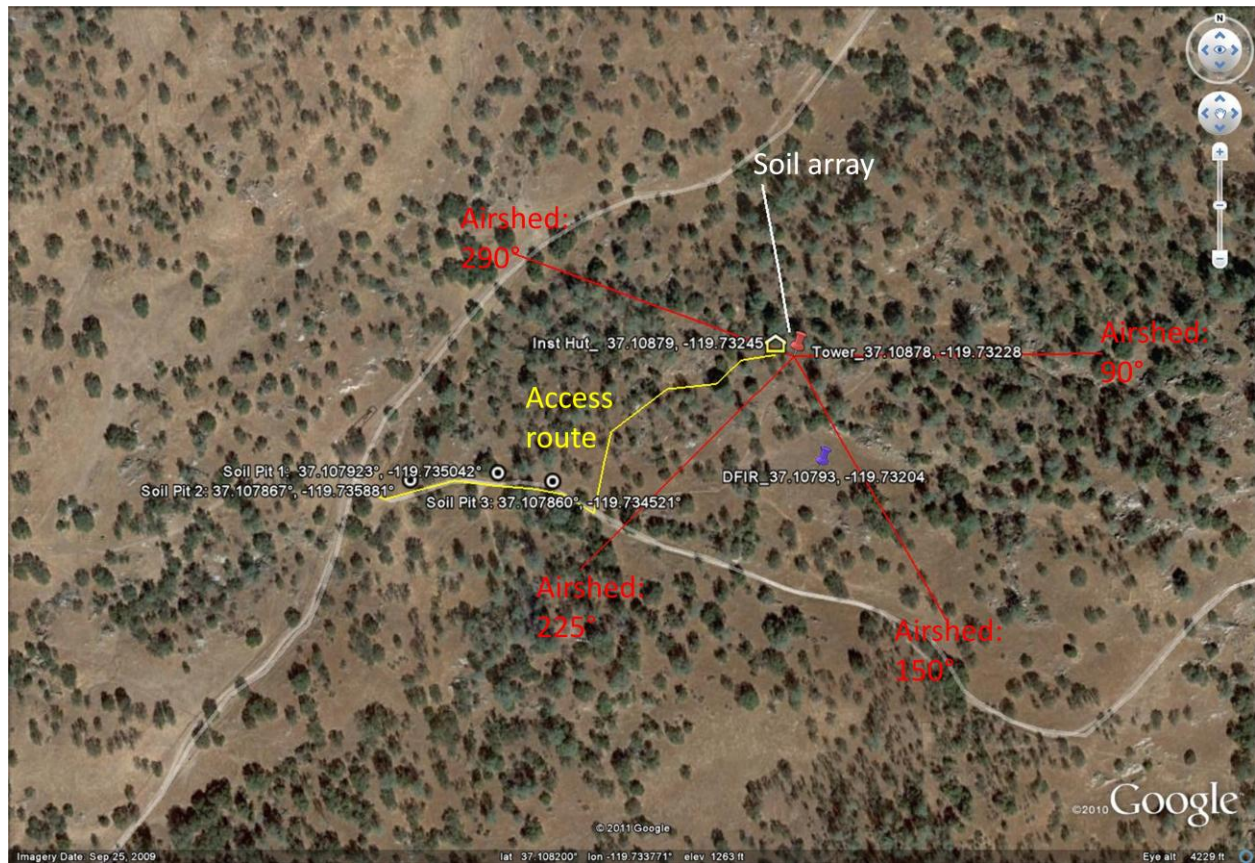

Figure 11. Site layout at San Joaquin showing soil array and location of the FIU soil pit. Note that there is an existing tower site nearby, and minimal interference is needed during construction.

3.4 Airshed

3.4.1 Seasonal windroses

Wind roses analytically determine and graphically represent the frequencies of wind direction and wind speed over a given timeseries, Figure 12. The weather data used to generate the following wind roses are from Dr Mike Goulden’s tower site at 37.108722°, -119.731561°, which is ~80 m from NEON tower site. The orientation of the wind rose follows that of a compass (assume declination applied). When we describe the wind directions it should be noted that they are the cardinal direction that wind blows from. The directions of the rose with the longest spoke show wind directions with the largest frequency. These wind roses are subdivided into as 24 cardinal directions.

3.4.2 Results (graphs for wind roses)

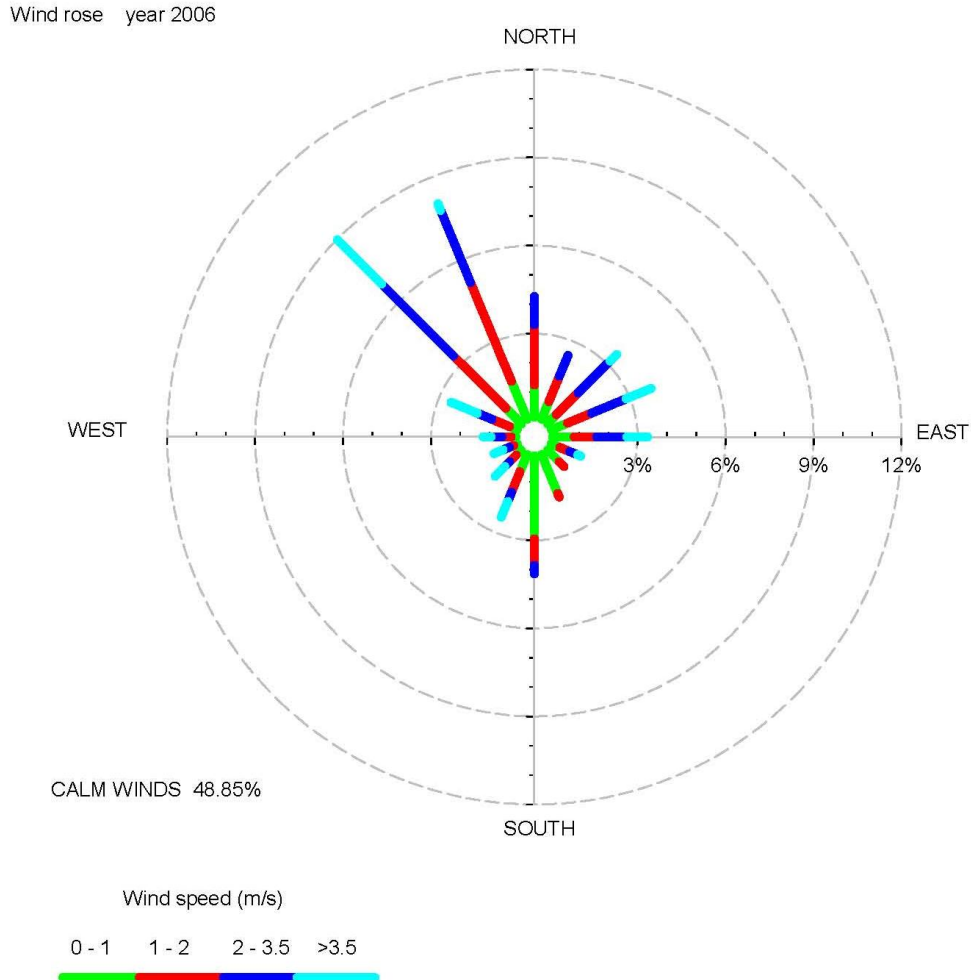

Figure 12. Windroses from the San Joaquin Core site.

Windrose diagram was provided by Dr M. Goulden’s group (UC Irvine). Windrose diagram was made from 2006 data from 37.108722°, -119.731561°, which is ~80 m from NEON tower site. It is assumed that the wind data was corrected for declination.

3.4.3 Resultant vectors

Not available.

3.4.4 Expected environmental controls on source area

Two types of models were commonly used to determine the shape and extent of the source area under different and contrasting atmospheric stability classes. An inverted plume dispersion model with

Title: D17 FIU Site Characterization: Supporting Data	Author: Luo/ Ayres/Loescher	Date: 09/26/2011
NEON Doc. #: NEON.DOC.011077		Revision: B

modeled cross wind solutions were used for convective conditions (Horst and Weil 1994). For strongly stable conditions, and Lagrangian solution was used (Kormann and Meixner 2001). The source area models were bounded by the expected conditions depict the extreme conditions. Convective conditions typically have strong vertical mixing between the ecosystem and atmosphere (surface layer). Stable conditions typically have long source area and associated waveforms. Convective turbulence is often characterized by short mixing scales (scalar) and moderate daytime wind speeds, *e.g.*, 1-4 m s⁻². Higher wind speeds, like those experienced over the Rockies, are often the product of mechanical turbulence with long waveforms. Because thermal stratification is very efficient in suppressing vertical mixing, stable conditions also have typically very long waveforms.

As a general rule, shorter and less structurally complex ecosystems have good vertical mixing during all atmospheric stabilities. Taller and more structurally complex ecosystems have well mixed upper canopies during the daytime, and can be decoupled below the canopy under neutral and stable conditions (*e.g.*, Harvard Forest, Bartlett Experimental Forest, and Burlington Conservation Area). The type of turbulence (mechanical versus convective) and the physical attributes of the ecosystem control the degree of mixing, and the length and size of the source area.

Here, we used a web-based footprint model to determine the footprint area under various conditions (model info: <http://www.geos.ed.ac.uk/abs/research/micromet/EdiTools/>). Winds used to run the model and generate following model results are extracted from the wind roses. Vegetation information, temperature and energy information were either from the RFI document, previous site visit report, available data files or best estimated from experienced expert. Measurement height was determined from the Tower Height requirements (NEON.FI.3.302, NEON.FI.3.303) and reported in Info document provided by ENG group, then verify according to the real ecosystem structure after FIU site characterization at site. Runs 1-3 and 4-6 represents the expected conditions for summer and winter conditions, respectively, with maximum and mean windspeeds (daytime convective) and nighttime (stable atmospheres) conditions. The wind vector for each run was estimated from wind roses and is placed as a centerline in the site map included in the graphics. The width of the footprint was also estimated using the length between the isopleth of 80% cumulative flux and center line to calculate the angle from centerline. This information, along with distance of the cumulative flux isopleths and wind direction, will define the source area for the flux measurements on the top of the tower.

Table 5. Expected environmental controls to parameterize the source area model, and associated results from San Joaquin advanced site.

Parameters	Run 1	Run 2	Run 3	Run 4	Run 5	Run 6	
Approximate season	summer			winter			Units
	Day (max WS)	Day (mean WS)	Night	Day (max WS)	Day (mean WS)	night	qualitative
Atmospheric stability	Convective	convective	Stable	Convective	convective	Stable	qualitative
Measurement height	36	36	36	36	36	36	m
Canopy Height	21	21	21	21	21	21	m
Canopy area density	3	3	3	1.5	1.5	1.5	m
Boundary layer depth	3500	3500	1800	1500	1500	1000	m
Expected sensible heat flux	650	650	175	300	300	50	W m ⁻²
Air Temperature	34	34	22	22	22	17	°C

Title: D17 FIU Site Characterization: Supporting Data	Author: Luo/ Ayres/Loescher	Date: 09/26/2011
NEON Doc. #: NEON.DOC.011077		Revision: B

Max. windspeed	5.6	2.6	1.6	5.6	2.6	1.6	m s ⁻¹
Resultant wind vector	316	316	181	316	316	181	degrees
Results							
(z-d)/L	-0.2	-0.17	-0.51	-0.1	-0.37	-0.34	m
d	17	17	17	15	15	15	m
Sigma v	2.9	2.7	1.5	2.2	1.8	0.92	m ² s ⁻²
Z0	0.93	0.93	0.93	1.3	1.30	1.3	m
u*	0.88	0.66	0.42	0.89	0.57	0.33	m s ⁻¹
Distance source area begins	0	0	0	0	0	0	m
Distance of 90% cumulative flux	700	250	250	800	400	450	m
Distance of 80% cumulative flux	450	200	200	500	250	230	m
Distance of 70% cumulative flux	350	150	150	400	200	200	m
Peak contribution	75	35	25	85	45	55	m

3.4.5 Results (source area graphs)

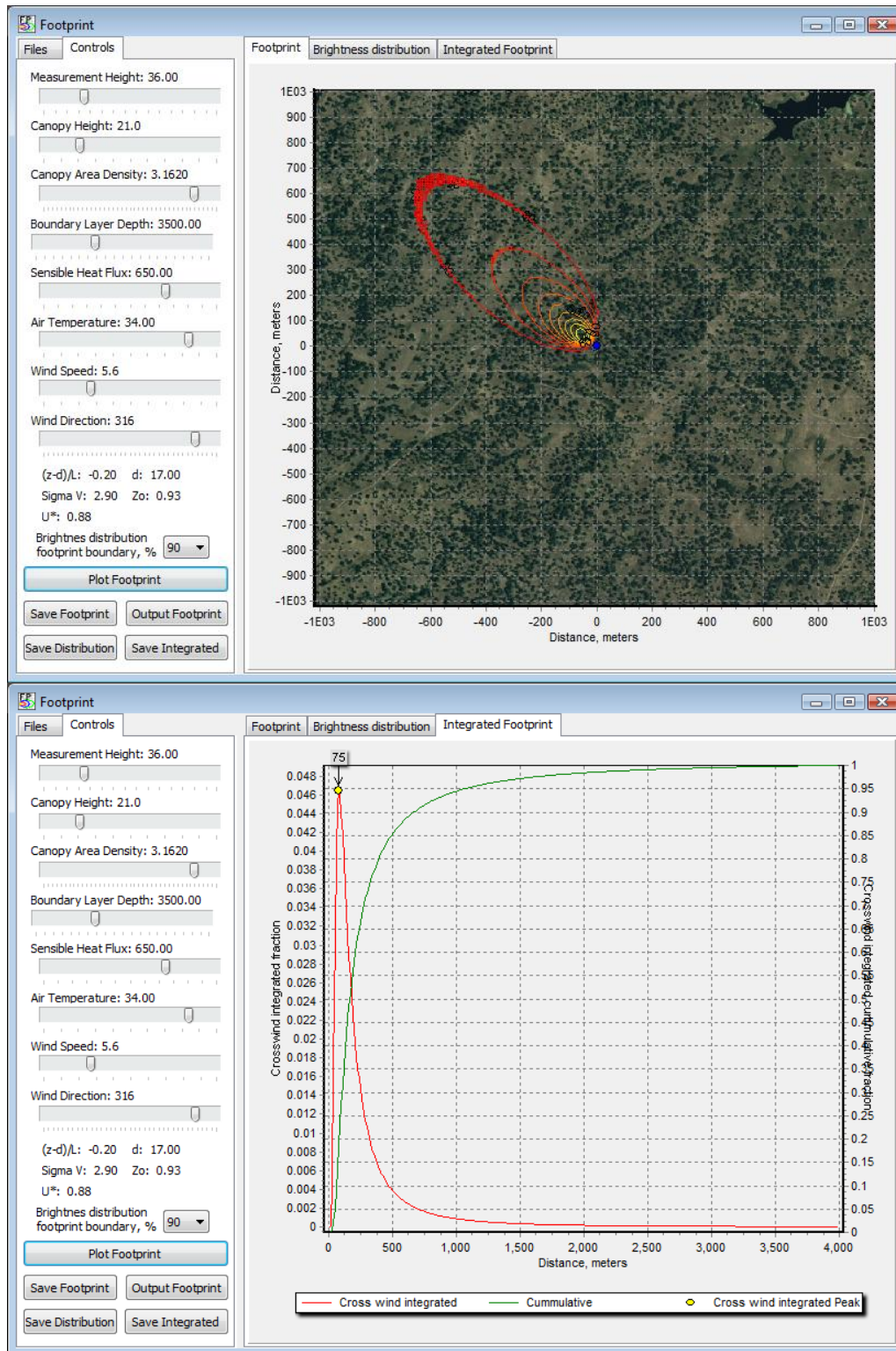

Figure 13. San Joaquin summer daytime (convective) footprint output with max wind speed.

Title: D17 FIU Site Characterization: Supporting Data	Author: Luo/ Ayres/Loescher	Date: 09/26/2011
NEON Doc. #: NEON.DOC.011077		Revision: B

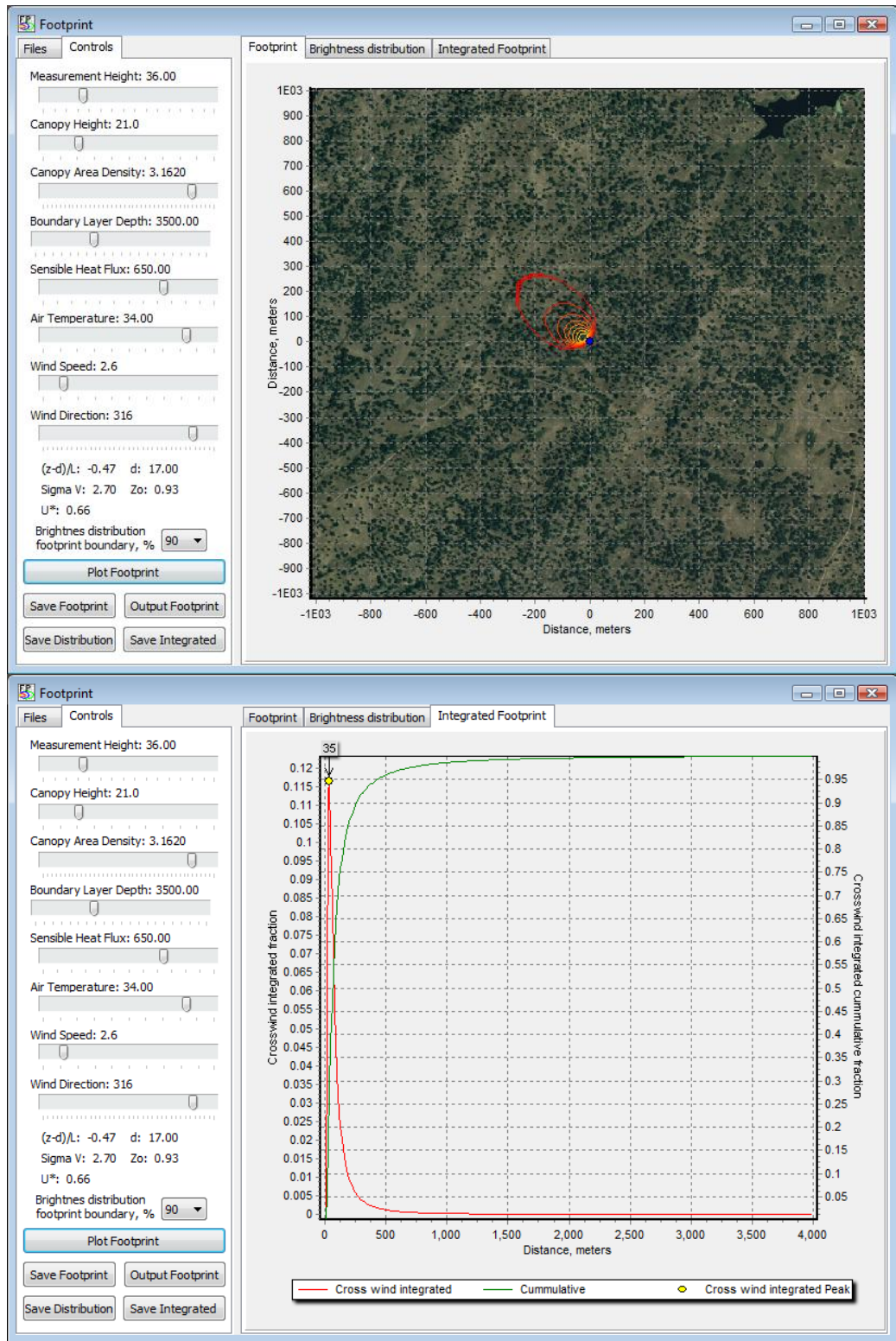

Figure 14. San Joaquin summer daytime (convective) footprint output with mean wind speed.

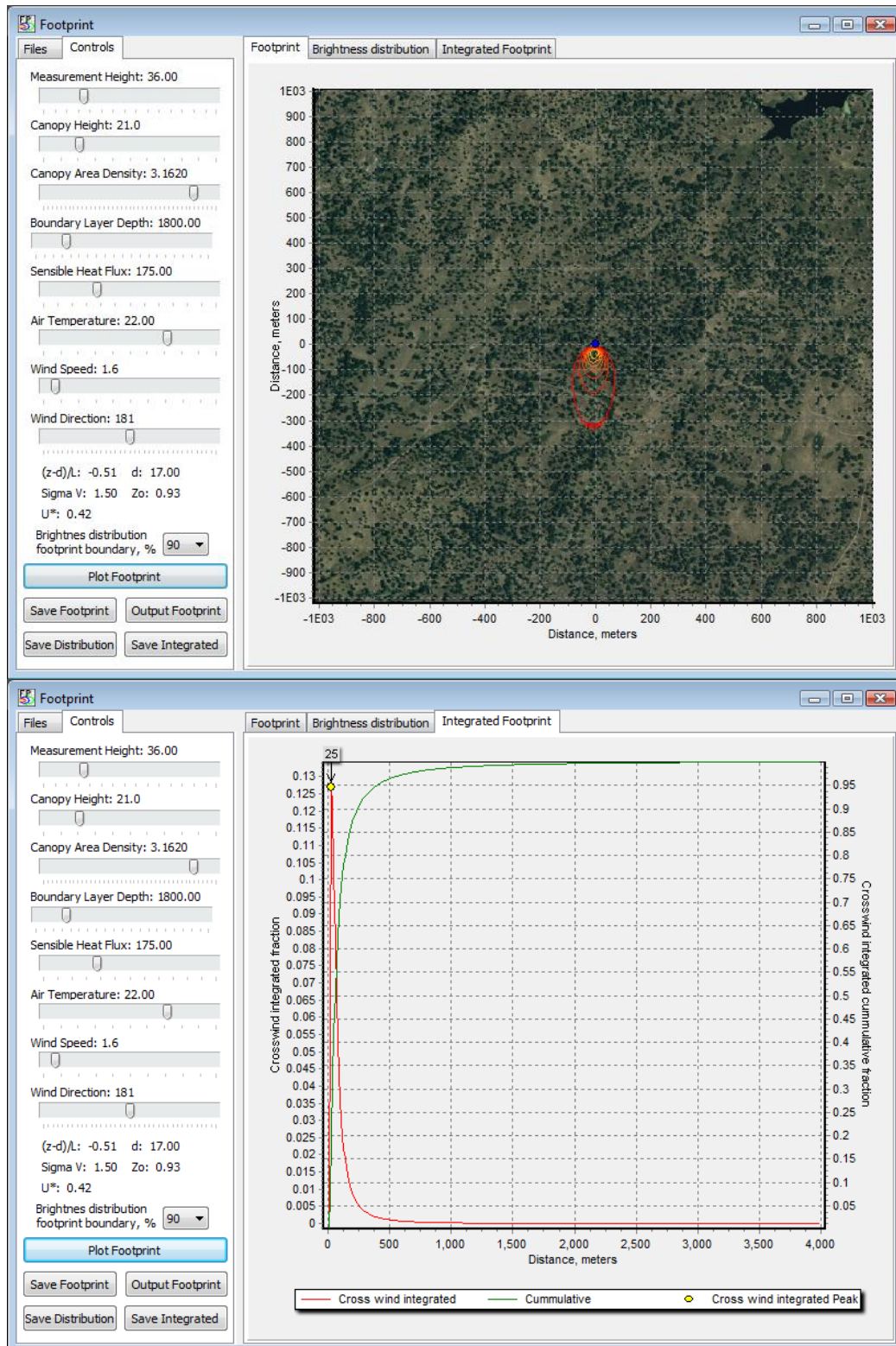

Figure 15. San Joaquin summer nighttime (stable) footprint output with mean wind speed.

Title: D17 FIU Site Characterization: Supporting Data	Author: Luo/ Ayres/Loescher	Date: 09/26/2011
NEON Doc. #: NEON.DOC.011077		Revision: B

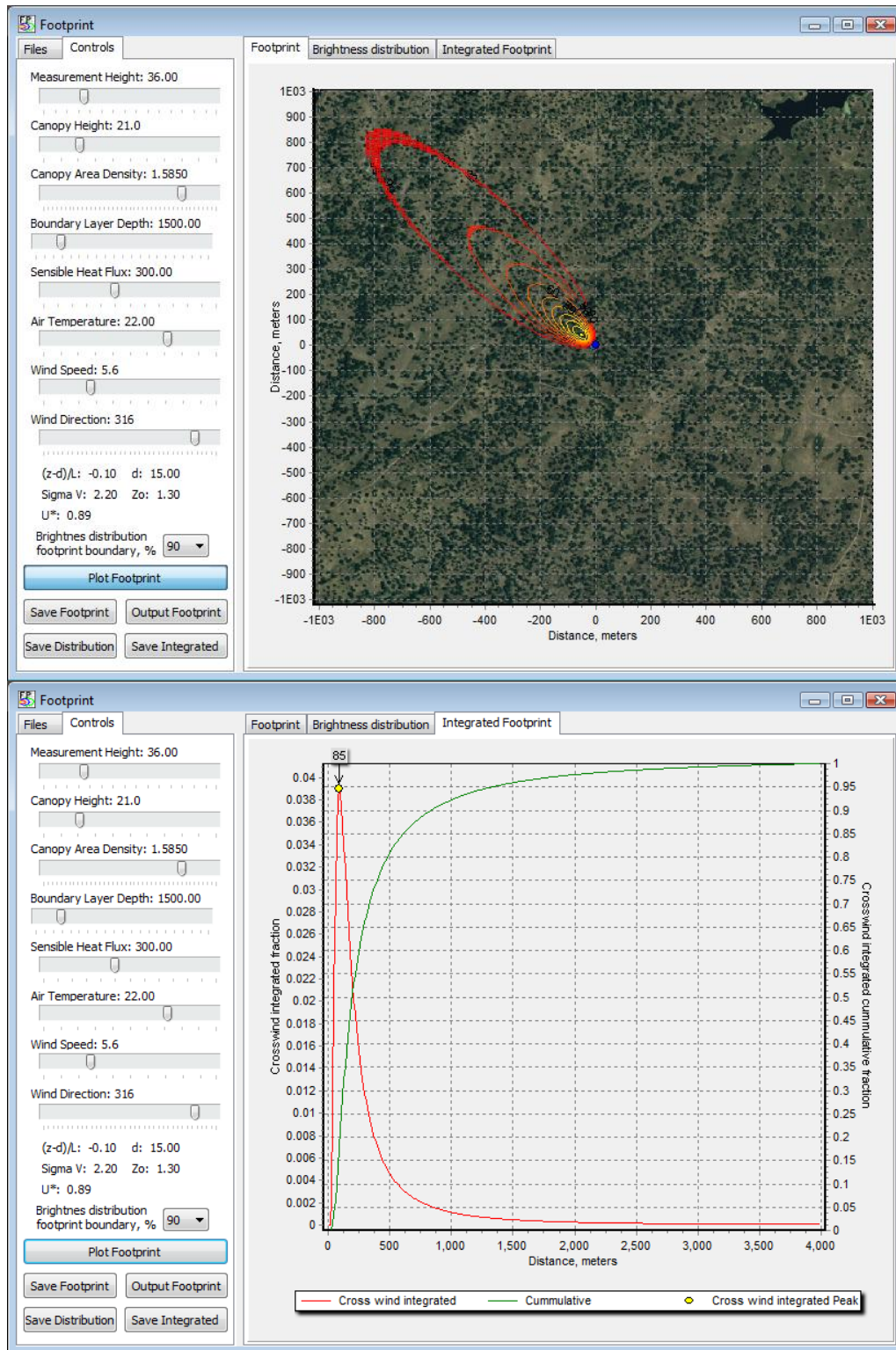

Figure 16. San Joaquin winter daytime (convective) footprint output with max wind speed.

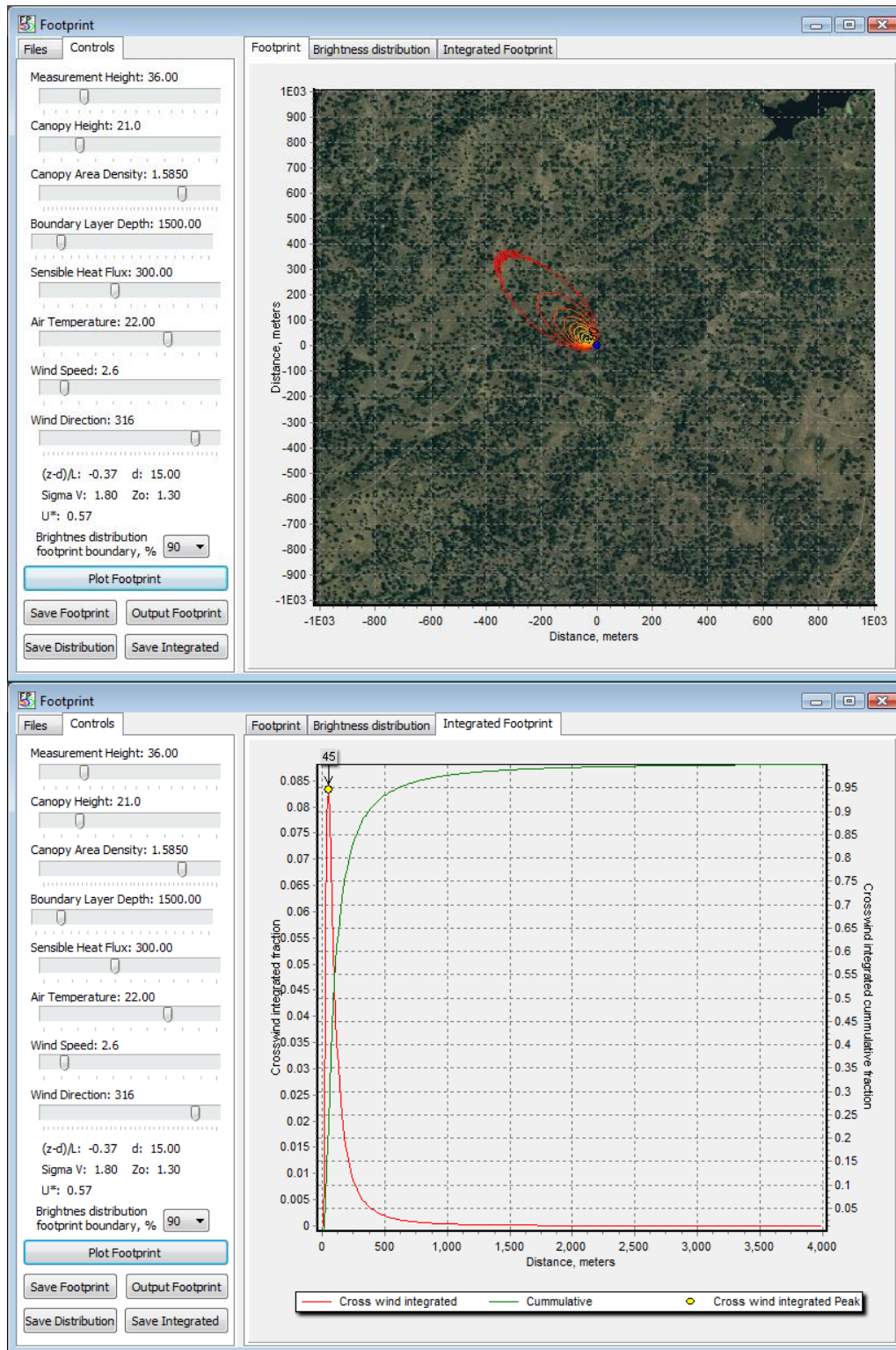

Figure 17. San Joaquin winter daytime (convective) footprint output with mean wind speed.

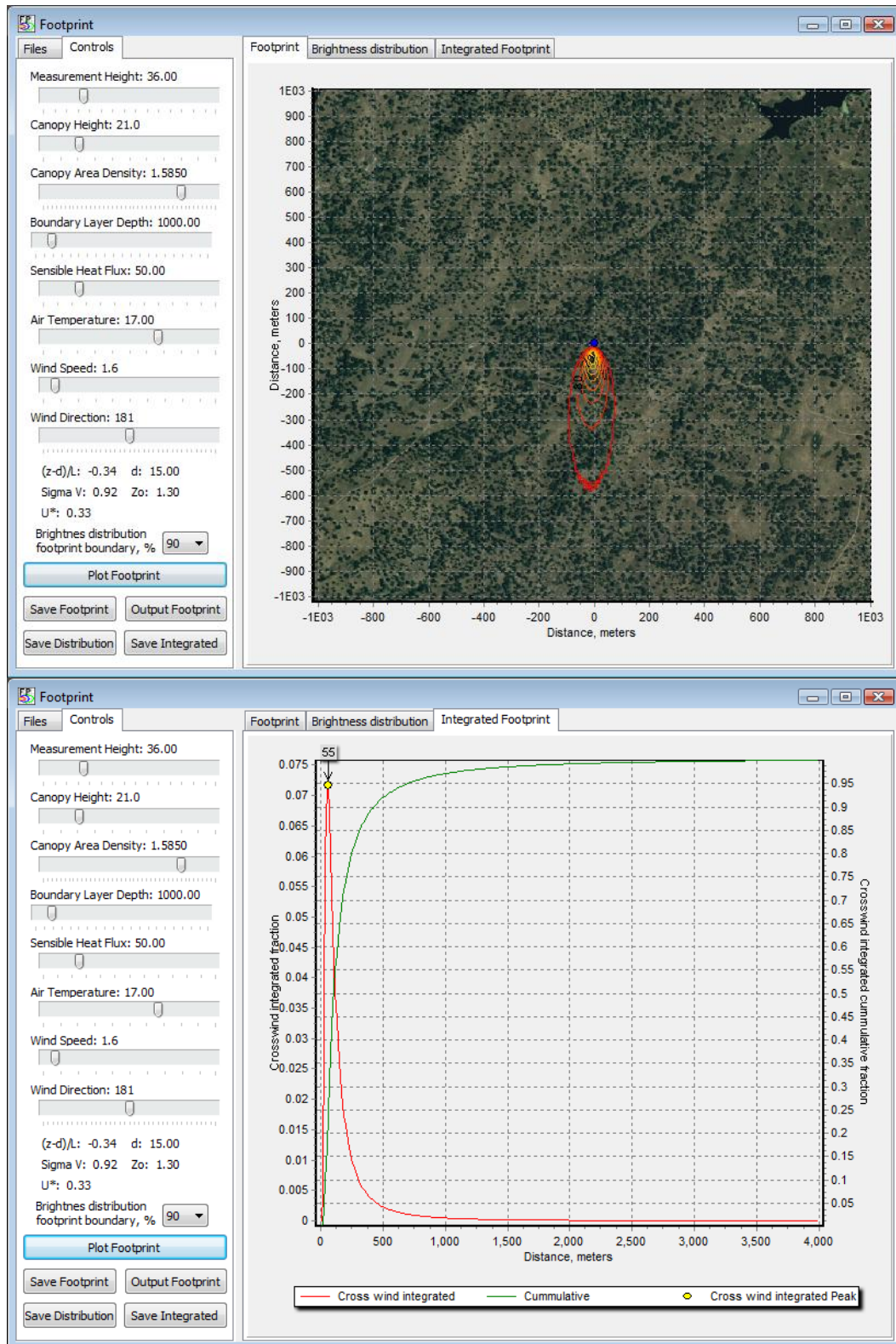

Figure 18. San Joaquin winter nighttime (stable) footprint output with mean wind speed.

Title: D17 FIU Site Characterization: Supporting Data	Author: Luo/ Ayres/Loescher	Date: 09/26/2011
NEON Doc. #: NEON.DOC.011077		Revision: B

3.5 Site design and tower attributes

According to wind roses, the prevailing wind direction comes from 290° to 90° (major airshed, clockwise from 290°) and from 150° to 225° (secondary airshed, clockwise from 150°) throughout the year. Tower should be placed to a location to best capture the signals from the airshed of the ecosystem of interest, which is oak-pine woodland savanna here. The original NEON candidate tower location (37.108722, -119.731561) has been taken by Dr M. Goulden (UC Irvine). Therefore, we microsites NEON tower location to 37.10878, -119.73228, which is ~ 85 m from original tower location. At this location, instruments on both NEON tower site and Dr Goulden’s site have clear access to the wind motions for major and secondary airshed and do not interfere each other (Figure 19).

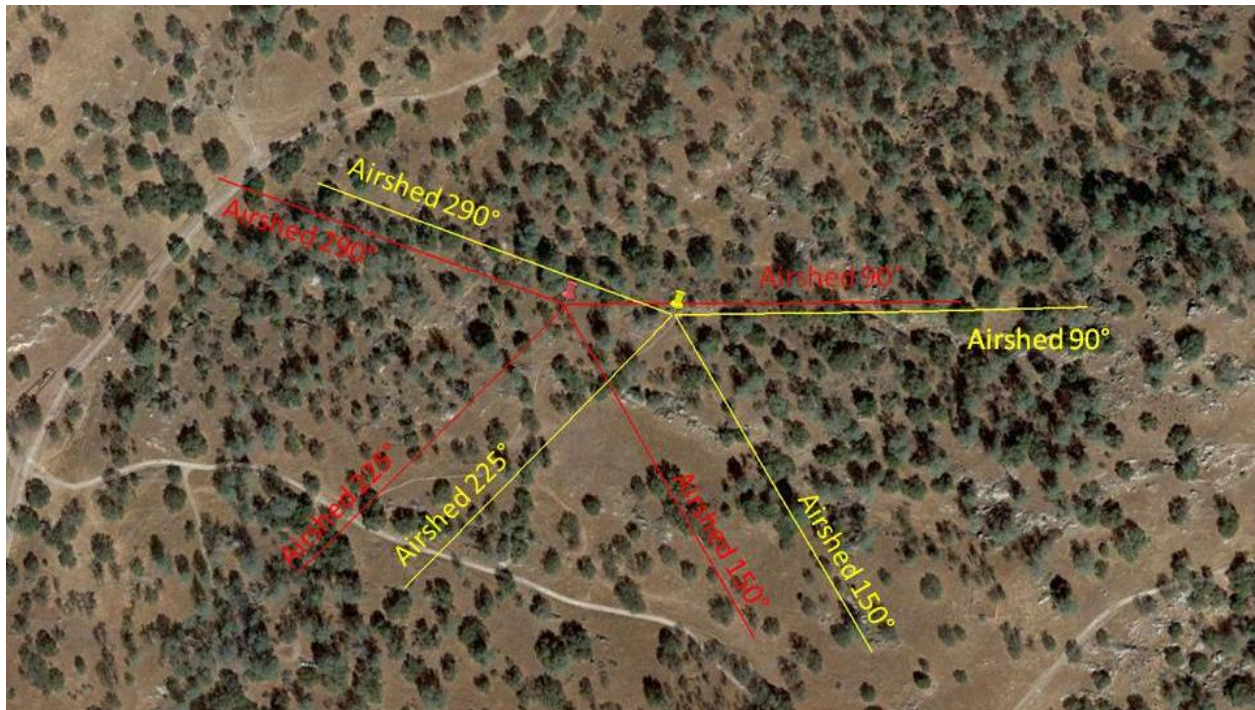

Figure 19. San Joaquin tower airshed.

Red pin is NEON tower, and red lines are associated airshed boundaries. Yellow pin is Dr Mike Goulden’s tower, and yellow lines are associated airshed boundaries. The airshed areas are from 290° to 90° (major airshed, clockwise from 290°) and from 150° to 225° (secondary airshed, clockwise from 150°). Both tower sites have clear wind path for major and secondary airshed and do not interfere each other

Eddy covariance, sonic wind and air temperature **boom arms** orientation toward the E will be best to capture signals from all major wind directions. **Radiation boom arms** should always be facing south to avoid any shadowing effects from the tower structure. An **instrument hut** should be outside the prevailing wind airshed to avoid disturbance in the measurements of wind and should be positioned to have the longer side parallel to frequent wind direction to minimize the wind effects on instrument huts and to minimize the disturbances of wind regime by instrument hut, and in this case, instrument hut should be positioned on the West side of tower and have the longer side parallel to SE-NW direction. Because this is an open Savanna ecosystem, we suggest the distance between the tower and the

Title: D17 FIU Site Characterization: Supporting Data	Author: Luo/ Ayres/Loescher	Date: 09/26/2011
NEON Doc. #: NEON.DOC.011077		Revision: B

instrument hut to be ~ 15 m. Therefore, we require the placement of instrument hut at 37.10879, -119.73245.

The ecosystem around tower and within the airshed at this site is oak woodland savanna, which also mixes with some digger pine trees. Oak is dominant by blue oaks. Tree canopy is very open. Tree overstory coverage counts for ~ 40% with ~2/3 for oak and 1/3 for pine. The canopy height is ~ 21 m for pine trees with lowest branch at 4.5 m, and canopy height ~ 12 m for oaks with the lowest branch at ~1.1 m above ground. Hawthorn and other shrubs form top understory with height ~ 5 m and scatter in Savanna. Herbaceous plants, generally annuals including grasses (e.g., pine bluegrass soft chess, foxtail fescue), form the understory at ground level and carpet on the floor. Grass height is ~ 0.6 m without the central stems and ~1.1 m with the central stems. Although blue oak is dominant tree species at this site, California Foothill pine trees are taller and have larger impacts on air flow dynamics at canopy surface layer. So pine tree height is used here to determine the tower height. Therefore, we require 6 **measurement layers** on the tower with top measurement height at 36 m, and rest layers are 24 m, 21 m, 5 m, 0.6 and 0.3 m, respectively, to best characterize the fluxes on the tower top and environmental conditions in profile.

DFIR (Double Fenced International Reference) will be used for bulk precipitation collection. Coordinates are 37.10793, -119.73204, which is ~100 m on SSE to tower. **Wet deposition collector** will collocate at the top of the tower. See AD 04 for further information and requirements for bulk precipitation collection and wet deposition collection.

The site layout is summarized in the table below. Assume the projected area of the tower is square. **Anemometer/temperature boom arm direction** is *from* the tower *toward* the prevailing wind direction or designated orientation. **Instrument hut orientation vector** is parallel to the long side of the instrument hut. **Instrument hut distance z** is the distance from the center of tower projection to the center of the instrument hut projection on the ground. The numbering of the **measurement levels** is that the lowest is level one, and each subsequent increase in height is numbered sequentially.

Table 6. Site design and tower attributes for San Joaquin Advanced site.

0° is true north with declination accounted for. Color of Instrument hut exterior shall be tan or best match the surrounding environment.

Attribute	lat	long	degree	meters	notes
Airshed area			290° to 90° (major), 150° to 225° (secondary)		Clockwise from first angle
Tower location	37.10878,	-119.73228	--	--	New site
Instrument hut	37.10879,	-119.73245			
Instrument hut orientation vector	--	--	140° - 320°		
Instrument hut distance z	--	--	--	15	

Title: D17 FIU Site Characterization: Supporting Data	Author: Luo/ Ayres/Loescher	Date: 09/26/2011
NEON Doc. #: NEON.DOC.011077		Revision: B

Anemometer/Temperature boom orientation	--	--	90°	--
DFIR	37.10793°	-119.73204°		
Height of the measurement levels				
Level 1			0.3	m.a.g.l.
Level 2			0.6	m.a.g.l.
Level 3			5.0	m.a.g.l.
Level 4			21.0	m.a.g.l.
Level 5			24.0	m.a.g.l.
Level 6			36.0	m.a.g.l.
Tower Height			36.0	m.a.g.l.

See AD 03 for technical requirement to determine the boom height for the bottom most measurement level.

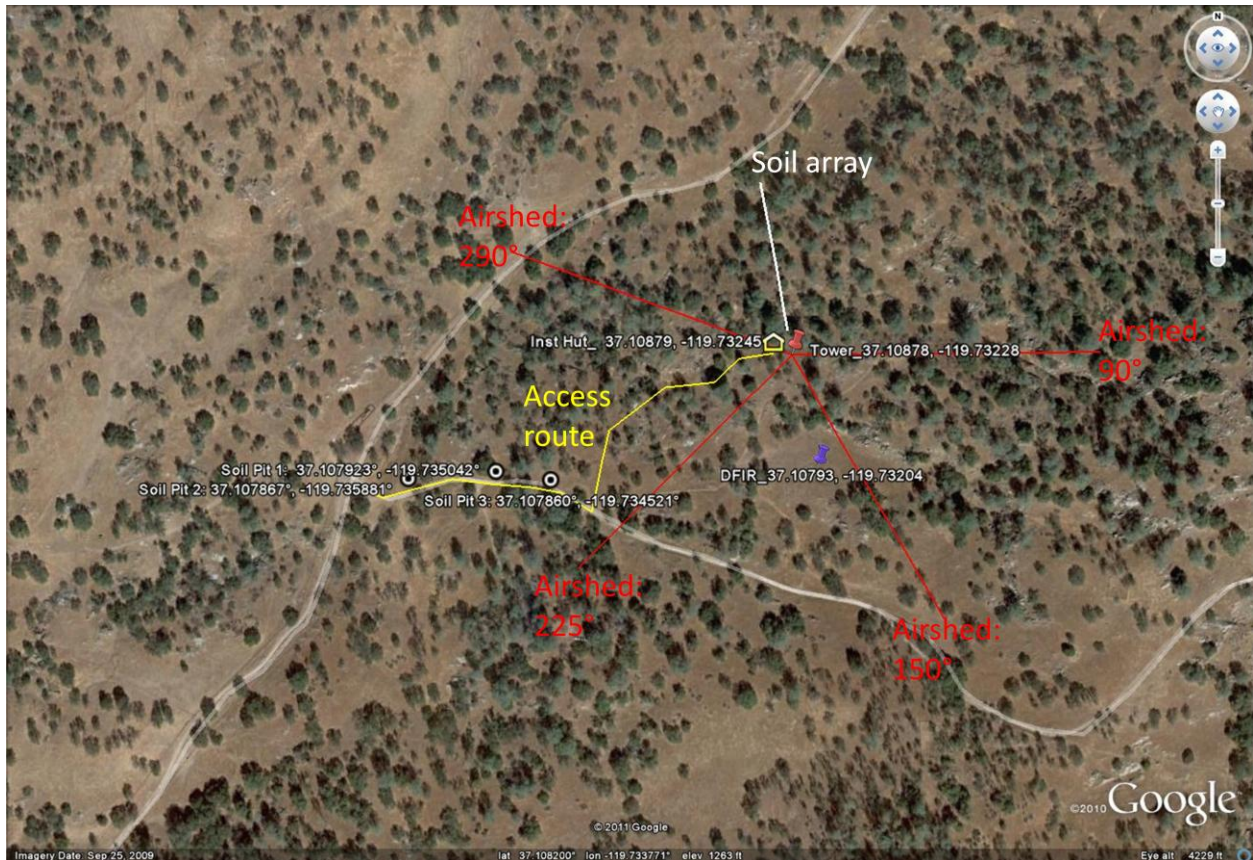

Figure 20. Site layout for San Joaquin tower site.

i) Tower location is presented (red pin), ii) red lines indicate the airshed boundaries. Vectors from 290° to 90° (major airshed, clockwise from 290°) and from 150° to 225° (secondary airshed, clockwise from 150°) are the airshed areas that would have quality wind data without causing flow distortions, respectively. iii) Yellow line is the suggested access road to instrument hut. iv) Purple pin is the DFIR location.

Title: D17 FIU Site Characterization: Supporting Data	Author: Luo/ Ayres/Loescher	Date: 09/26/2011
NEON Doc. #: NEON.DOC.011077		Revision: B

Boardwalks. Ultimately, the decision to use a boardwalk will be, in part, based on owner’s preferences. There are strong science requirements that minimize site disturbance to the surrounding area, which will be difficult to manage over a 30-y period. Traffic control is key to minimizing the site disturbance. Confining foot traffic to boardwalks minimizes site impact; this is particularly true in places where wear caused by foot traffic becomes noticeable and grows. For example, in places with snow part of the year, worn footpaths tend to have low places that collect water, or places where the snow pack becomes uneven causing personnel to walk farther and farther around the sides of the original path, causing the path to grow in width. This is a very common phenomenon. Here, FIU assumes that all conduits will be either buried, or placed inside the boardwalk such that it does not extend beyond the 36” (0.914 m). wide footprint. The boardwalk to access the tower is not on any side that has a boom.

Specific Boardwalks at this site:

- All walkways in this location shall be gravel, same width as standard boardwalk. This is because boardwalks cause enhanced risk to technicians because they create safe haven for rattlesnakes and because of the presence of cattle.
- Gravel walkway is from the access point to instrument hut, pending landowner decision
- Gravel walkway from the instrument hut to the tower to intersect on north face of the tower
- Gravel walkway to soil array.
- No Gravel walkway from the soil array Gravel walkway to the individual soil plots
- No gravel walkway needed to DFIR site

The relative locations between tower, instrument hut and boardwalk can be found in the Figure below:

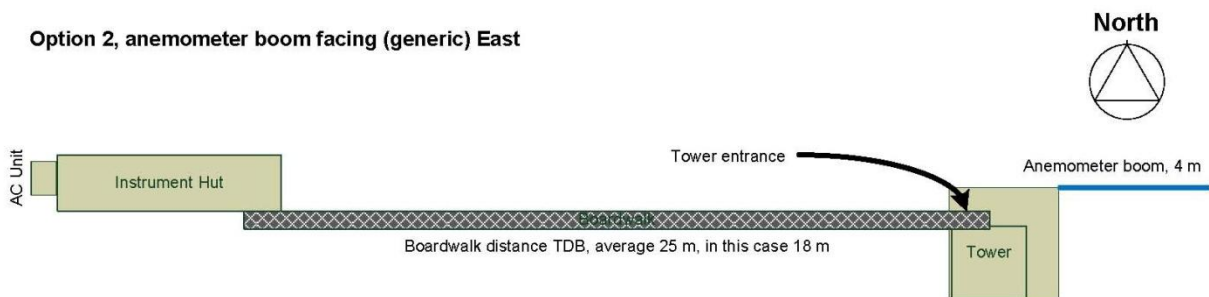

Figure 21. Generic diagram to demonstration the relationship between tower and instrument hut when boom facing east and instrument hut on the west towards the tower.

This is a generic diagram. The actual layout of boardwalk (or path if no boardwalk required) and instrument hut position will be the joint responsibility of FCC and FIU. At this site, the boom angle will be 90 degrees, instrument hut will be on the west towards the tower, the distance between instrument hut and tower is ~15 m. The instrument hut vector will be SE-NW (140° - 320°, longwise).

3.6 Information for ecosystem productivity plots

The tower at San Joaquin Advanced site has been positioned to optimize the collection of the air/wind signals both temporally and spatially over the desired ecosystem (Oak-pine Savanna). Tower airshed areas are from 290° to 90° (major airshed, clockwise from 290°) and from 150° to 225° (secondary airshed, clockwise from 150°) throughout the year, and 90% signals for flux measurements are in a distance of 450 m from tower, and 80% within 250 m during mean wind conditions, but can reach 800 m and 500 m, respectively, at max wind speed. We suggest FSU Ecosystem Productivity plots be placed

Title: D17 FIU Site Characterization: Supporting Data	Author: Luo/ Ayres/Loescher	Date: 09/26/2011
NEON Doc. #: NEON.DOC.011077		Revision: B

within the boundaries of 290° to 90° (major airshed, clockwise from 290°) and 150° to 225° (secondary airshed, clockwise from 150°) from tower.

3.7 Issues and attentions

An existing tower located on the E toward NEON tower site is ~85 m away, which was the original NEON candidate tower site. San Joaquin Experimental Range approved Dr M. Goulden (UC Irvine) to establish this tower at NEON's site based on the understanding that he will collect the historic data that can be used by NEON, and his tower will be torn down when NEON tower is ready to construct. But according to the communication with Dr Goulden during our site characterization visit, he expressed the interests to keep his tower running at that location as long as he can. To be a good neighbor in the research community but without allowing NEON science to suffer, we picked a tower location ~ 85 m away from original tower location. This location will allow us to measure the same area of the savanna ecosystem as we designed, and allow the comparison of the two towers but without interference each other's measurements on tower.

Rodents chewing wires is common at this site. All cables and wires need good protection.

Gated area provides good security.

Cattle grazing is present at this site.

Rocky outcrops are common at this site. Exact soil plot locations may need to be micrositied to avoid rocky outcrops.

Soil is clay and compacted, and can be very hard during the dry season.

Title: D17 FIU Site Characterization: Supporting Data	Author: Luo/ Ayres/Loescher	Date: 09/26/2011
NEON Doc. #: NEON.DOC.011077		Revision: B

4 SOAPROOT SADDLE, RELOCATEABLE TOWER 1

4.1 Site description

NEON candidate Relocatable site was located at 37.031069°, -119.256431° (Figure 22). Because this site is too far away from power to be viable, we relocated the tower location to 37.03337°, -119.26219°.

The new tower location is on a lower steppe in the Sierras but higher elevation from San Joaquin. Topography is a complex terrain with coarse large hills and valleys. This site is approximately 4-5 km from University of California at Irvine tower. This site is expected to get 20% snow and 80% rain, and capture the snow-rain transition. The site is situated on the top of a knoll in the saddle area, though the knoll itself is not the high point in elevation in the soaproot saddle area. Power is close nearby. Winter access will be by foot, ski, snow machine or ATV.

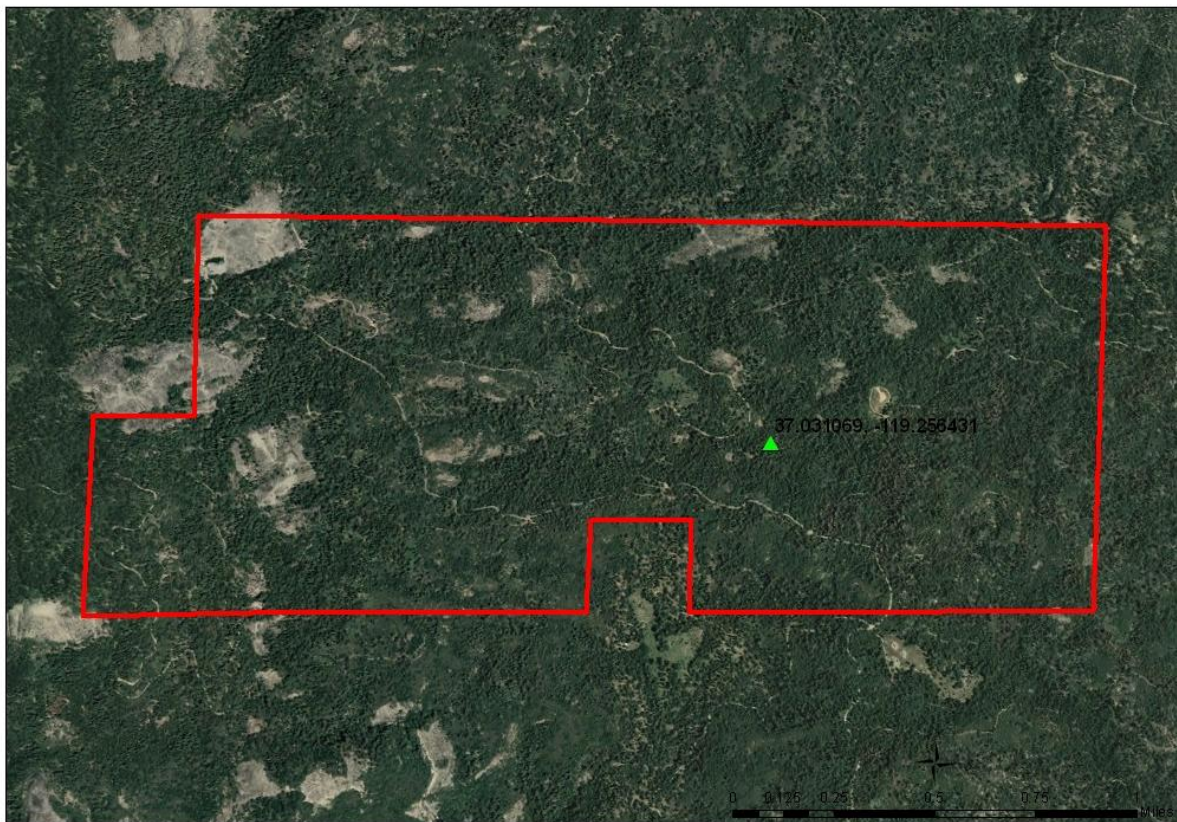

Domain 17 - Soaproot Saddle

▲ NEON Candidate Location
 □ Soaproot Saddle Property Boundary

Figure 22. Soaproot Saddle boundary map and NEON original candidate tower location.

Soaproot Saddle belongs to the County of Fresno, California. The closest populated place is that of Bretz Mill that is 1.21 miles far from Soaproot Saddle. Soaproot Saddle is also ~7 miles far from the closest airport or heliport. (Information source: <http://usa.indettaglio.it/eng/06/019/234805.html>).

Title: D17 FIU Site Characterization: Supporting Data	Author: Luo/ Ayres/Loescher	Date: 09/26/2011
NEON Doc. #: NEON.DOC.011077		Revision: B

Nearest Cities: (info source:

http://www.anyplaceamerica.com/topographic_maps/california/fresno_county/soaproot_saddle/52908/)

City	County, State	Approximate Distance
<u>Shaver Lake</u>	Modoc County, California	~ 6.2 miles
<u>Tollhouse</u>	Modoc County, California	~ 7.6 miles
<u>Big Creek</u>	Modoc County, California	~ 12.2 miles
<u>Auberry</u>	Modoc County, California	~ 12.7 miles
<u>Piedra</u>	Modoc County, California	~ 16.5 miles

Climate: (info source:

http://www.anyplaceamerica.com/topographic_maps/california/fresno_county/soaproot_saddle/52908/)

Weather averages from 1971 to 2000, according to data gathered from the **nearest** official weather station. Because the nearest station and this geographic feature may have differences in elevation and topography, the historic weather at the two separate locations **may be different** as well.

Temp. Station: BALCH POWER HO, ~11.9 miles | **Elevation:** 1720 feet (2174 feet difference)

Precip. Station: BALCH POWER HO, ~11.9 miles | **Elevation:** 1720 feet (2174 feet difference)

Month	Precip	AVG High Temp	AVG Low Temp	H-M Year*	L-M Year**
January	6.10"	52.5°	37.4°	1986	1972
February	5.69"	58.1°	39.6°	1991	1998
March	5.38"	63.2°	42.1°	1972	1973
April	2.36"	69.8°	45.6°	1989	1975
May	1.17"	77.6°	52.4°	1997	1998
June	.48"	86.2°	59.3°	1981	1998
July	.17"	93.2°	66.3°	1996	1983
August	.05"	93.3°	66.6°	1996	1976
September	.94"	88.0°	61.9°	1991	1986
October	1.59"	77.3°	53.1°	1991	1984
November	3.22"	60.0°	43.2°	1995	1994
December	3.83"	52.1°	37.6°	1977	1971

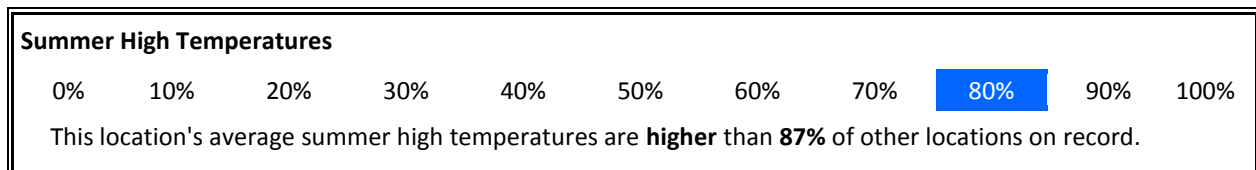

<i>Title:</i> D17 FIU Site Characterization: Supporting Data	<i>Author:</i> Luo/ Ayres/Loescher	<i>Date:</i> 09/26/2011
<i>NEON Doc. #:</i> NEON.DOC.011077		<i>Revision:</i> B

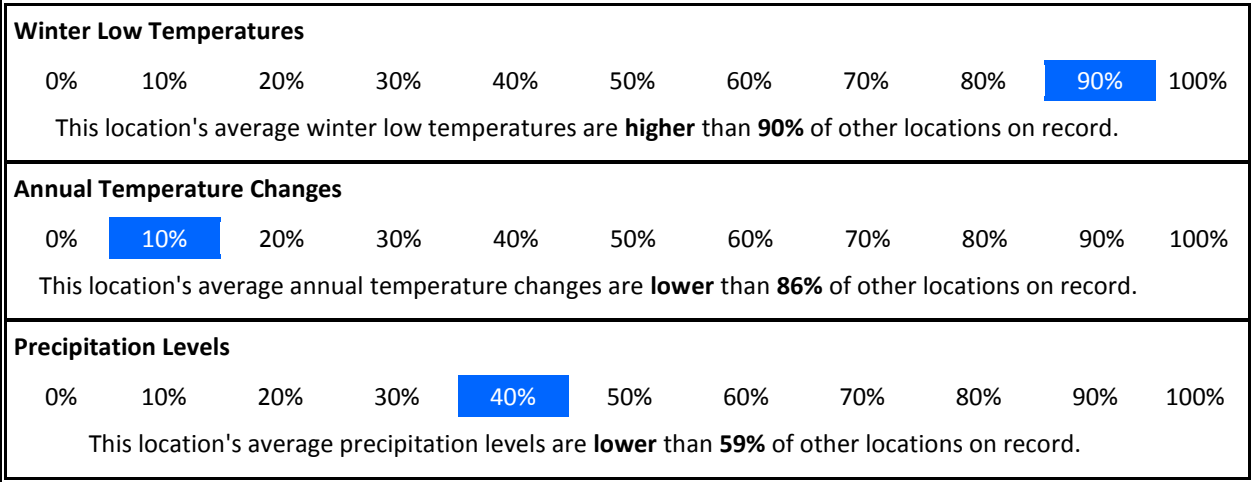

4.2 Ecosystem

Vegetation type and land cover information at this relocatable site are presented below:

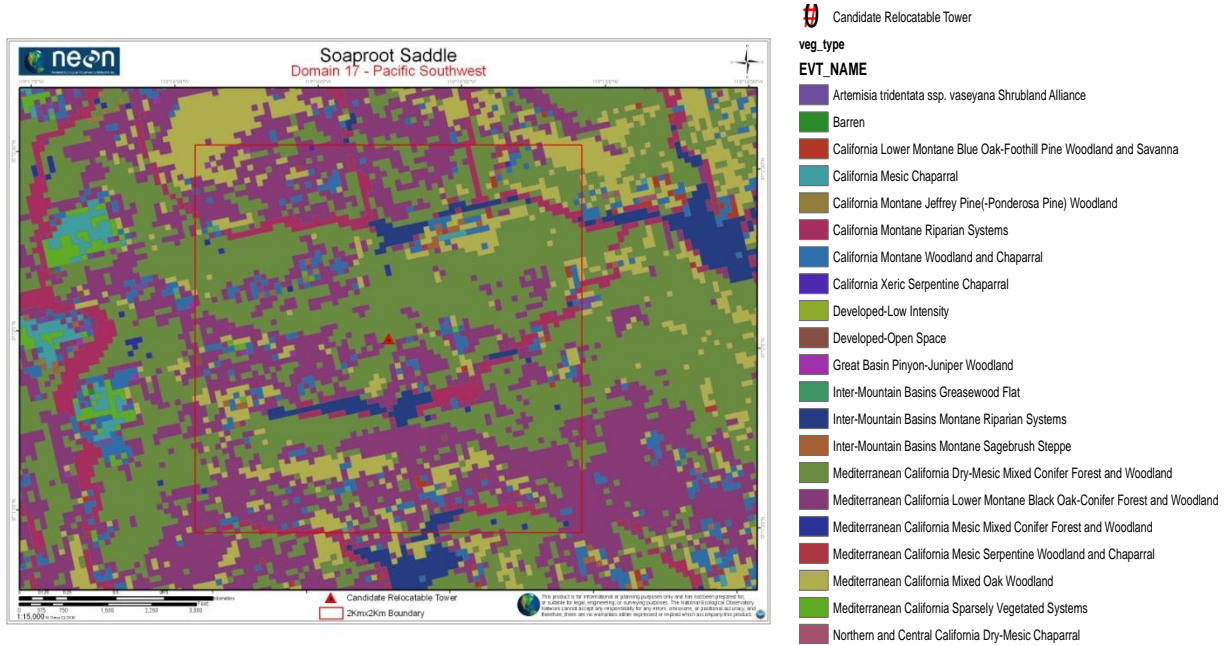

Figure 23. Vegetative cover map of the Soaproot Saddle relocatable site and surrounding areas (from USGS, <http://landfire.cr.usgs.gov/viewer/viewer.htm>).

Table 7. Percent Land cover information at the Soaproot Saddle relocatable site (from USGS, <http://landfire.cr.usgs.gov/viewer/viewer.htm>)

Vegetation_Type	Area_km ²	Percentage
Artemisia tridentata ssp. vaseyana Shrubland Alliance	0.00	0.08
California Lower Montane Blue Oak-Foothill Pine Woodland and Savanna	0.01	0.23

Title: D17 FIU Site Characterization: Supporting Data	Author: Luo/ Ayres/Loescher	Date: 09/26/2011
NEON Doc. #: NEON.DOC.011077		Revision: B

California Mesic Chaparral	0.01	0.18
California Montane Jeffrey Pine(-Ponderosa Pine) Woodland	0.00	0.05
California Montane Riparian Systems	0.19	4.70
California Montane Woodland and Chaparral	0.17	4.22
California Xeric Serpentine Chaparral	0.00	0.05
Developed-Open Space	0.00	0.07
Great Basin Pinyon-Juniper Woodland	0.00	0.09
Inter-Mountain Basins Greasewood Flat	0.00	0.02
Inter-Mountain Basins Montane Riparian Systems	0.12	2.90
Inter-Mountain Basins Montane Sagebrush Steppe	0.02	0.39
Mediterranean California Dry-Mesic Mixed Conifer Forest and Woodland	1.66	41.43
Mediterranean California Lower Montane Black Oak-Conifer Forest and Woodland	1.37	34.30
Mediterranean California Mesic Mixed Conifer Forest and Woodland	0.01	0.29
Mediterranean California Mesic Serpentine Woodland and Chaparral	0.01	0.24
Mediterranean California Mixed Oak Woodland	0.42	10.55
Mediterranean California Sparsely Vegetated Systems	0.01	0.18
Northern and Central California Dry-Mesic Chaparral	0.00	0.07
Total Area Sq Km	4.00	100.00

Ecosystem at this site is a naturally regenerated stand with a mix of ponderosa and sugar pines, incense cedar, sequoia and redwood and some white fir. Blue oaks and madrone are sparsely throughout the understory. A dense carpet of sage and sparse holly are on the ground cover. Dominant trees are ponderosa pine ~32 m in height. Canopy is open with incident light striking the forest floor in large patches/sunflecks. This forest block is managed by fire. Large fire scars, root ball burnouts, and burnt slash present. We expect the last fire was 2-3 years ago. Across the road from the tower site is not burnt, but expect to be burnt in near future due to the large fuel loading. In the places near to the tower location, large clere story-gallery forests with first braches level at ~ 8-9 m in height. Ground cover is predominantly sage with height ~ 0.3 – 1 m. Punctuated in the area are patches of various sizes of oak and madrone with height ~ 4-6 m. Source area will incorporate various management blocks that are expected different prescribed burn frequencies, which required for a taller tower due to the roughness of the surface.

Title: D17 FIU Site Characterization: Supporting Data	Author: Luo/ Ayres/Loescher	Date: 09/26/2011
NEON Doc. #: NEON.DOC.011077		Revision: B



Figure 24. Ecosystem and surrounding environment at the Soaproot Saddle relocatable site. Fire is a management tool applied here.

Table 8. Ecosystem and site attributes for Soaproot Saddle Relocatable site.

Ecosystem attributes	Measure and units
Mean canopy height	32.0 m
Surface roughness ^a	4 m
Zero place displacement height ^a	26 m
Structural elements	Ponderosa pine dominant forest, open canopy, with various heights of trees and shrubs, super dense floor cover by sage
Time zone	Pacific time zone
Magnetic declination	13° 33' E changing by 0° 6' W/year

Note, ^a From field survey.

4.3 Soils

4.3.1 Description of soils

Soil data and soil maps below for the Soaproot Saddle tower site were collected from 9.0 km² NRCS soil maps (<http://websoilsurvey.nrcs.usda.gov/app/HomePage.htm>) to determine the dominant soil types in the larger tower foot print. This was done to assure that the soil array is in the dominant (or in the co-dominant) soil type present in the tower footprint.

Title: D17 FIU Site Characterization: Supporting Data	Author: Luo/ Ayres/Loescher	Date: 09/26/2011
NEON Doc. #: NEON.DOC.011077		Revision: B

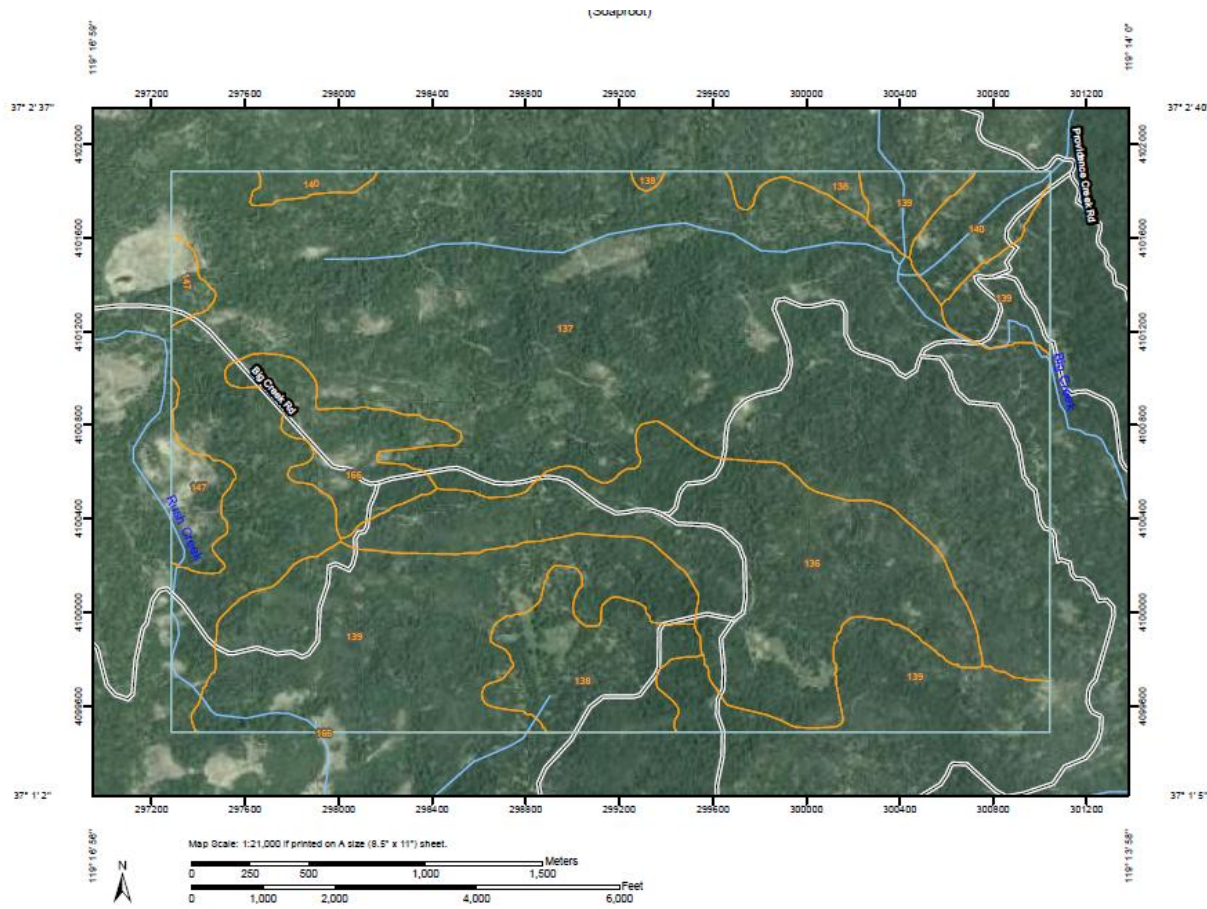

Figure 25. Soil map of the Soaproot Saddle site and surrounding areas.

Soil Map Units Description: The map units delineated on the detailed soil maps in a soil survey represents the soils or miscellaneous areas in the survey area. The map unit descriptions in this report, along with the maps, can be used to determine the composition and properties of a unit. A map unit delineation on a soil map represents an area dominated by one or more major kinds of soil or miscellaneous areas. A map unit is identified and named according to the taxonomic classification of the dominant soils. Within a taxonomic class there are precisely defined limits for the properties of the soils. On the landscape, however, the soils are natural phenomena, and they have the characteristic variability of all natural phenomena. Thus, the range of some observed properties may extend beyond the limits defined for a taxonomic class. Areas of soils of a single taxonomic class rarely, if ever, can be mapped without including areas of other taxonomic classes. Consequently, every map unit is made up of the soils or miscellaneous areas for which it is named and some minor components that belong to taxonomic classes other than those of the major soils. Most minor soils have properties similar to those of the dominant soil or soils in the map unit, and thus they do not affect use and management. These are called non-contrasting, or similar, components. They may or may not be mentioned in a particular map unit description. Other minor components, however, have properties and behavioral characteristics divergent enough to affect use or to require different management. These are called contrasting, or dissimilar, components. They generally are in small areas and could not be mapped separately because of the scale used. Some small areas of strongly contrasting soils or miscellaneous areas are identified by a special symbol on the maps. If included in the database for a given area, the

Title: D17 FIU Site Characterization: Supporting Data	Author: Luo/ Ayres/Loescher	Date: 09/26/2011
NEON Doc. #: NEON.DOC.011077		Revision: B

contrasting minor components are identified in the map unit descriptions along with some characteristics of each. A few areas of minor components may not have been observed, and consequently they are not mentioned in the descriptions, especially where the pattern was so complex that it was impractical to make enough observations to identify all the soils and miscellaneous areas on the landscape. The presence of minor components in a map unit in no way diminishes the usefulness or accuracy of the data. The objective of mapping is not to delineate pure taxonomic classes but rather to separate the landscape into landforms or landform segments that have similar use and management requirements. The delineation of such segments on the map provides sufficient information for the development of resource plans. If intensive use of small areas is planned, however, onsite investigation is needed to define and locate the soils and miscellaneous areas. An identifying symbol precedes the map unit name in the map unit descriptions. Each description includes general facts about the unit and gives important soil properties and qualities.

Soils that have profiles that are almost alike make up a *soil series*. All the soils of a series have major horizons that are similar in composition, thickness, and arrangement. Soils of a given series can differ in texture of the surface layer, slope, stoniness, salinity, degree of erosion, and other characteristics that affect their use. On the basis of such differences, a soil series is divided into *soil phases*. Most of the areas shown on the detailed soil maps are phases of soil series. The name of a soil phase commonly indicates a feature that affects use or management. For example, Alpha silt loam, 0 to 2 percent slopes, is a phase of the Alpha series. Some map units are made up of two or more major soils or miscellaneous areas. These map units are complexes, associations, or undifferentiated groups. A *complex* consists of two or more soils or miscellaneous areas in such an intricate pattern or in such small areas that they cannot be shown separately on the maps. The pattern and proportion of the soils or miscellaneous areas are somewhat similar in all areas. Alpha-Beta complex, 0 to 6 percent slopes, is an example. An *association* is made up of two or more geographically associated soils or miscellaneous areas that are shown as one unit on the maps. Because of present or anticipated uses of the map units in the survey area, it was not considered practical or necessary to map the soils or miscellaneous areas separately. The pattern and relative proportion of the soils or miscellaneous areas are somewhat similar. Alpha-Beta association, 0 to 2 percent slopes, is an example. An *undifferentiated group* is made up of two or more soils or miscellaneous areas that could be mapped individually but are mapped as one unit because similar interpretations can be made for use and management. The pattern and proportion of the soils or miscellaneous areas in a mapped area are not uniform. An area can be made up of only one of the major soils or miscellaneous areas, or it can be made up of all of them. Alpha and Beta soils, 0 to 2 percent slopes, are an example. Some surveys include *miscellaneous areas*. Such areas have little or no soil material and support little or no vegetation. Rock outcrop is an example. Additional information about the map units described in this report is available in other soil reports, which give properties of the soils and the limitations, capabilities, and potentials for many uses. Also, the narratives that accompany the soil reports define some of the properties included in the map unit descriptions.

Table 9. Soil series and percentage of soil series within 9.0 km² at the Soaproot Saddle site

Title: D17 FIU Site Characterization: Supporting Data	Author: Luo/ Ayres/Loescher	Date: 09/26/2011
NEON Doc. #: NEON.DOC.011077		Revision: B

Sierra National Forest Area Parts of Fresno, California (CA750)			
Map Unit Symbol	Map Unit Name	Acres in AOI	Percent of AOI
136	HOLLAND FAMILY, 5 TO 35 PERCENT SLOPES	324.3	14.6%
137	HOLLAND FAMILY, 35 TO 65 PERCENT SLOPES	1,166.0	52.3%
138	HOLLAND-CHAIX FAMILIES COMPLEX, 5 TO 35 PERCENT SLOPES	116.3	5.2%
139	HOLLAND-CHAIX FAMILIES COMPLEX, 35 TO 65 PERCENT SLOPES	449.8	20.2%
140	HOLLAND-CHAWANAKEE FAMILIES COMPLEX, 35 TO 65 PERCENT SLOPES	58.2	2.6%
147	ROCK OUTCROP	40.5	1.8%
166	TOLLHOUSE FAMILY-ROCK OUTCROP COMPLEX, 30 TO 60 PERCENT SLOPES	72.3	3.2%
Totals for Area of Interest		2,227.5	100.0%

Sierra National Forest Area Parts of Fresno, California 136—HOLLAND FAMILY, 5 TO 35 PERCENT SLOPES **Map Unit Setting** Elevation: 3,600 to 5,800 feet Mean annual precipitation: 30 to 50 inches Mean annual air temperature: 46 to 59 degrees F Frost-free period: 150 to 200 days **Map Unit Composition** Holland family and similar soils: 90 percent Minor components: 10 percent **Description of Holland Family Setting** Landform: Ridges Landform position (two-dimensional): Shoulder Landform position (three-dimensional): Upper third of mountainflank Down-slope shape: Concave Across-slope shape: Convex Parent material: Residuum weathered from granodiorite **Properties and qualities** Slope: 5 to 35 percent Depth to restrictive feature: 66 to 70 inches to paralithic bedrock Drainage class: Well drained Capacity of the most limiting layer to transmit water (Ksat): Very low to moderately low (0.00 to 0.14 in/hr) Depth to water table: More than 80 inches Frequency of flooding: None Frequency of ponding: None Available water capacity: High (about 9.2 inches) **Interpretive groups** Land capability (nonirrigated): 6e **Typical profile** 0 to 7 inches: Sandy loam 7 to 60 inches: Sandy clay loam 60 to 66 inches: Sandy loam 66 to 70 inches: Weathered bedrock **Minor Components** **Chaix family** Percent of map unit: 5 percent **Unnamed** Percent of map unit: 5 percent

Sierra National Forest Area Parts of Fresno, California 137—HOLLAND FAMILY, 35 TO 65 PERCENT SLOPES **Map Unit Setting** Elevation: 3,600 to 5,800 feet Mean annual precipitation: 30 to 50 inches Mean annual air temperature: 46 to 59 degrees F Frost-free period: 150 to 200 days **Map Unit Composition** Holland family and similar soils: 85 percent Minor components: 15 percent **Description of Holland Family Setting** Landform: Mountains Landform position (two-dimensional): Backslope Landform position (three-dimensional): Mountainflank Down-slope shape: Concave Across-slope shape: Concave Parent material: Residuum weathered from granodiorite **Properties and qualities** Slope: 35 to 65 percent Depth to restrictive feature: 66 to 70 inches to paralithic bedrock Drainage class: Well drained Capacity of the most limiting layer to transmit water (Ksat): Very low to moderately low (0.00 to 0.14 in/hr) Depth to water table: More than 80 inches Frequency of flooding: None Frequency of ponding: None Available water capacity: High (about 9.2 inches) **Interpretive groups** Land capability (nonirrigated): 7e **Typical profile** 0 to 7 inches: Sandy loam 7 to 60 inches: Sandy clay loam 60 to 66

Title: D17 FIU Site Characterization: Supporting Data	Author: Luo/ Ayres/Loescher	Date: 09/26/2011
NEON Doc. #: NEON.DOC.011077		Revision: B

inches: Sandy loam 66 to 70 inches: Weathered bedrock **Minor Components Chaix family** Percent of map unit: 5 percent **Chawanakee family** Percent of map unit: 5 percent **Rock outcrop** Percent of map unit: 5 percent

Sierra National Forest Area Parts of Fresno, California 138—HOLLAND-CHAIX FAMILIES COMPLEX, 5 TO 35 PERCENT SLOPES Map Unit Setting Elevation: 2,700 to 5,550 feet Mean annual precipitation: 30 to 40 inches Mean annual air temperature: 46 to 59 degrees F Frost-free period: 150 to 200 days **Map Unit Composition** Holland family and similar soils: 65 percent Chaix family and similar soils: 20 percent Minor components: 15 percent **Description of Holland Family Setting** Landform: Mountains Landform position (two-dimensional): Shoulder Landform position (three-dimensional): Mountainflank Down-slope shape: Concave Across-slope shape: Concave Parent material: Residuum weathered from granodiorite **Properties and qualities** Slope: 5 to 35 percent Depth to restrictive feature: 66 to 70 inches to paralithic bedrock Drainage class: Well drained Capacity of the most limiting layer to transmit water (Ksat): Very low to moderately low (0.00 to 0.14 in/hr) Depth to water table: More than 80 inches Frequency of flooding: None Frequency of ponding: None Available water capacity: High (about 9.2 inches) **Interpretive groups** Land capability (nonirrigated): 6e **Typical profile** 0 to 7 inches: Sandy loam 7 to 60 inches: Sandy clay loam 60 to 66 inches: Sandy loam 66 to 70 inches: Weathered bedrock **Description of Chaix Family Setting** Landform: Ridges Landform position (two-dimensional): Shoulder Landform position (three-dimensional): Upper third of mountainflank Down-slope shape: Concave Across-slope shape: Convex Parent material: Residuum weathered from granodiorite **Properties and qualities** Slope: 5 to 35 percent Depth to restrictive feature: 36 to 40 inches to paralithic bedrock Drainage class: Somewhat excessively drained Capacity of the most limiting layer to transmit water (Ksat): Very low to moderately low (0.00 to 0.14 in/hr) Depth to water table: More than 80 inches Frequency of flooding: None Frequency of ponding: None Available water capacity: Low (about 3.2 inches) **Interpretive groups** Land capability (nonirrigated): 6e **Typical profile** 0 to 6 inches: Coarse sandy loam 6 to 36 inches: Coarse sandy loam 36 to 40 inches: Weathered bedrock **Minor Components Rock outcrop** Percent of map unit: 5 percent **Auberry family** Percent of map unit: 5 percent **Ahwahnee family** Percent of map unit: 5 percent

Sierra National Forest Area Parts of Fresno, California 139—HOLLAND-CHAIX FAMILIES COMPLEX, 35 TO 65 PERCENT SLOPES Map Unit Setting Elevation: 2,700 to 5,550 feet Mean annual precipitation: 30 to 40 inches Mean annual air temperature: 46 to 59 degrees F Frost-free period: 150 to 200 days **Map Unit Composition** Holland family and similar soils: 60 percent Chaix family and similar soils: 20 percent Minor components: 20 percent **Description of Holland Family Setting** Landform: Ridges Landform position (two-dimensional): Backslope Landform position (three-dimensional): Upper third of mountainflank Down-slope shape: Concave Across-slope shape: Concave Parent material: Residuum weathered from granodiorite **Properties and qualities** Slope: 35 to 65 percent Depth to restrictive feature: 66 to 70 inches to paralithic bedrock Drainage class: Well drained Capacity of the most limiting layer to transmit water (Ksat): Very low to moderately low (0.00 to 0.14 in/hr) Depth to water table: More than 80 inches Frequency of flooding: None Frequency of ponding: None Available water capacity: High (about 9.2 inches) **Interpretive groups** Land capability (nonirrigated): 7e **Typical profile** 0 to 7 inches: Sandy loam 7 to 60 inches: Sandy clay loam 60 to 66 inches: Sandy loam 66 to 70 inches: Weathered bedrock **Description of Chaix Family Setting** Landform: Ridges Landform position (two-dimensional): Backslope Landform position (three-dimensional): Upper third of mountainflank Down-slope shape: Concave Across-slope shape: Convex Parent material: Residuum weathered from granodiorite **Properties and qualities** Slope: 35 to 65 percent Depth to restrictive feature: 36 to 40

Title: D17 FIU Site Characterization: Supporting Data	Author: Luo/ Ayres/Loescher	Date: 09/26/2011
NEON Doc. #: NEON.DOC.011077		Revision: B

inches to paralithic bedrock Drainage class: Somewhat excessively drained Capacity of the most limiting layer to transmit water (Ksat): Very low to moderately low (0.00 to 0.14 in/hr) Depth to water table: More than 80 inches Frequency of flooding: None Frequency of ponding: None Available water capacity: Low (about 3.2 inches) **Interpretive groups** Land capability (nonirrigated): 7e **Typical profile** 0 to 6 inches: Coarse sandy loam 6 to 36 inches: Coarse sandy loam 36 to 40 inches: Weathered bedrock **Minor Components Rock outcrop** Percent of map unit: 5 percent **Unnamed, moderately deep** Percent of map unit: 5 percent **Chawanakee family** Percent of map unit: 5 percent **Tollhouse family** Percent of map unit: 5 percent

Sierra National Forest Area Parts of Fresno, California 140—HOLLAND-CHAWANAKEE FAMILIES COMPLEX, 35 TO 65 PERCENT SLOPES Map Unit Setting Elevation: 3,000 to 6,000 feet Mean annual precipitation: 30 to 45 inches Mean annual air temperature: 46 to 59 degrees F Frost-free period: 150 to 200 days **Map Unit Composition** Holland family and similar soils: 50 percent Chawanakee family and similar soils: 35 percent Minor components: 15 percent **Description of Holland Family Setting** Landform: Mountains Landform position (two-dimensional): Backslope Landform position (three-dimensional): Mountainflank Down-slope shape: Concave Across-slope shape: Concave Parent material: Residuum weathered from granodiorite **Properties and qualities** Slope: 35 to 65 percent Depth to restrictive feature: 66 to 70 inches to paralithic bedrock Drainage class: Well drained Capacity of the most limiting layer to transmit water (Ksat): Very low to moderately low (0.00 to 0.14 in/hr) Depth to water table: More than 80 inches Frequency of flooding: None Frequency of ponding: None Available water capacity: High (about 9.2 inches) **Interpretive groups** Land capability (nonirrigated): 7e **Typical profile** 0 to 7 inches: Sandy loam 7 to 60 inches: Sandy clay loam 60 to 66 inches: Sandy loam 66 to 70 inches: Weathered bedrock **Description of Chawanakee Family Setting** Landform: Mountains Landform position (two-dimensional): Backslope Landform position (three-dimensional): Mountainflank Down-slope shape: Concave Across-slope shape: Convex Parent material: Residuum weathered from granodiorite **Properties and qualities** Slope: 35 to 65 percent Depth to restrictive feature: 10 to 20 inches to paralithic bedrock Drainage class: Somewhat excessively drained Capacity of the most limiting layer to transmit water (Ksat): Very low to moderately low (0.00 to 0.14 in/hr) Depth to water table: More than 80 inches Frequency of flooding: None Frequency of ponding: None Available water capacity: Very low (about 1.1 inches) **Interpretive groups** Land capability (nonirrigated): 7e **Typical profile** 0 to 4 inches: Coarse sandy loam 4 to 19 inches: Coarse sandy loam 19 to 23 inches: Weathered bedrock **Minor Components Rock outcrop** Percent of map unit: 5 percent **Chaix family** Percent of map unit: 5 percent **Unnamed, moderately deep** Percent of map unit: 5 percent

Sierra National Forest Area Parts of Fresno, California 147—ROCK OUTCROP Map Unit Composition Rock outcrop: 90 percent Minor components: 10 percent **Description of Rock Outcrop Setting** Landform: Mountains Landform position (two-dimensional): Backslope Landform position (three-dimensional): Mountainflank Down-slope shape: Concave Across-slope shape: Convex **Interpretive groups** Land capability (nonirrigated): 8 **Typical profile** 0 to 4 inches: Unweathered bedrock **Minor Components** Unnamed, shallow Percent of map unit: 10 percent

Sierra National Forest Area Parts of Fresno, California 166—TOLLHOUSE FAMILY-ROCK OUTCROP COMPLEX, 30 TO 60 PERCENT SLOPES Map Unit Setting Elevation: 2,000 to 5,000 feet Mean annual precipitation: 25 to 35 inches Mean annual air temperature: 54 to 59 degrees F Frost-free period: 45 to 75 days **Map Unit Composition** Tollhouse family and similar soils: 65 percent Rock outcrop: 25 percent Minor components: 10 percent **Description of Tollhouse Family Setting** Landform: Mountains Landform

Title: D17 FIU Site Characterization: Supporting Data	Author: Luo/ Ayres/Loescher	Date: 09/26/2011
NEON Doc. #: NEON.DOC.011077		Revision: B

position (two-dimensional): Backslope Landform position (three-dimensional): Mountainflank, mountainbase Down-slope shape: Concave Across-slope shape: Convex Parent material: Residuum weathered from quartz-diorite **Properties and qualities** Slope: 30 to 60 percent Depth to restrictive feature: 18 to 22 inches to paralithic bedrock Drainage class: Somewhat excessively drained Capacity of the most limiting layer to transmit water (Ksat): Very low to moderately low (0.00 to 0.14 in/hr) Depth to water table: More than 80 inches Frequency of flooding: None Frequency of ponding: None Available water capacity: Very low (about 1.4 inches) **Interpretive groups** Land capability (nonirrigated): 7e **Typical profile** 0 to 18 inches: Gravelly coarse sandy loam 18 to 22 inches: Weathered bedrock **Description of Rock Outcrop Setting** Landform: Mountains Landform position (two-dimensional): Backslope Landform position (three-dimensional): Mountainflank, mountainbase Down-slope shape: Concave Across-slope shape: Convex **Interpretive groups** Land capability (nonirrigated): 8 **Typical profile** 0 to 4 inches: Unweathered bedrock **Minor Components Holland family** Percent of map unit: 4 percent **Chaix family** Percent of map unit: 3 percent **Auberry family** Percent of map unit: 3 percent

4.3.2 Soil semi-variogram description

The goal of this aspect of the site characterization is to determine the minimum distance between the soil plots in the soil array such that data farther apart can be considered spatially independent. The collected field data will be used to produce semivariograms, which is a geostatistical technique to characterize spatial autocorrelation between mapped samples of a quantitative variable (*e.g.*, soil property data in our case). In an empirical semivariogram, the average of the squared differences of a response variable is computed for all pairs of points within specified distance intervals (lag classes). The output is presented graphically as a plot of the average semi-variance versus distance class (Figure 26). For the theoretical variogram models considered here, the semivariance will converge on the total variance at distances for which values are no longer spatially auto-correlated (this is referred to as the range, Figure 26).

For the theoretical variograms considered here, three parameters estimated from the data are used to fit a semivariogram model to the empirical semivariogram. This model is then assumed to quantitatively represent the correlation as a function of distance (Figure 26), the range, the sill (the sill is the asymptotic value of semi-variance at the range), and the nugget (which describes sampling error or variation at distances below those separating the closest pairs of samples). The range, sill and nugget are estimated from theoretical models that are fitted to the empirical variograms using non-linear least squares methods.

The variogram analysis will be used, to determine the spatial scales at which we can consider soil measurements spatially independent. This characterization will directly inform the minimum distance between *i*) soil plots within each soil array, *ii*) the soil profile measurements, *iii*) EP plots, and *iv*) the microbial sampling locations. These data will directly inform NEON construction and site design activities.

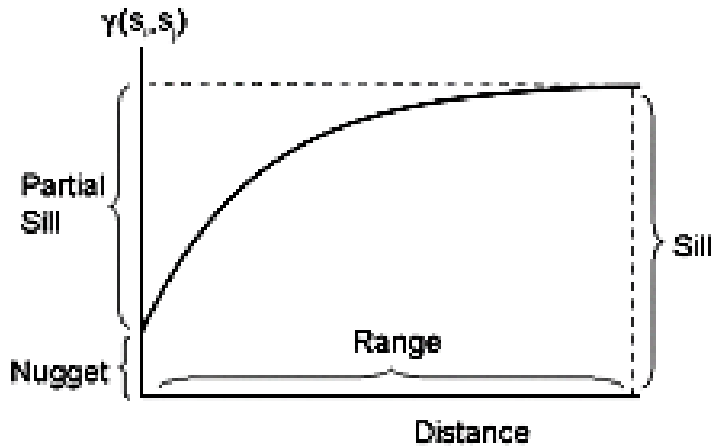

Figure 26. Example semivariogram, depicting range, sill, and nugget.

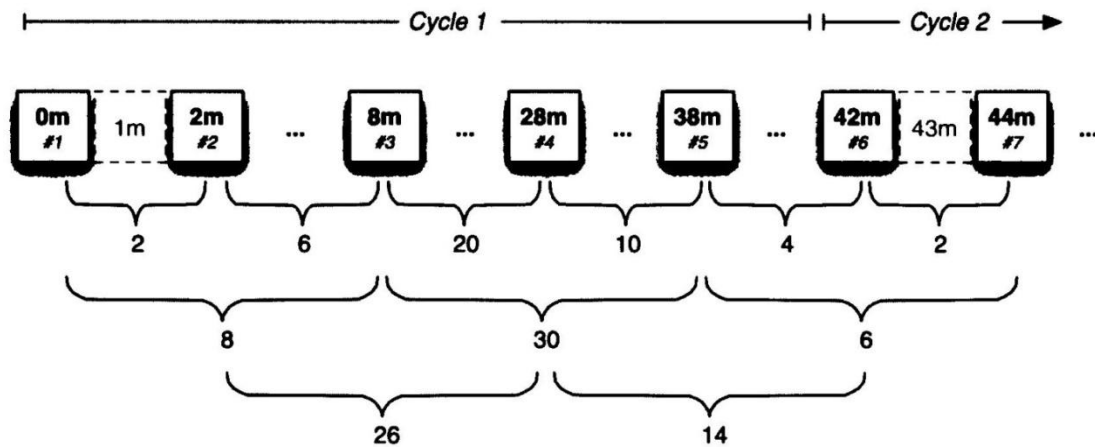

Figure 27. Spatially cyclic sampling design for the measurements of soil temperature and soil water content.

Field measurements of soil temperature (0-12 cm) and moisture (0-15 cm) were taken on 15 July 2010 at the Soaproot Saddle site. The sampling points followed the spatially cyclic sampling design by Bond-Lamberty et al. (2006) (Figure 27). Soil temperature and moisture measurements were collected along three transects (168 m, 84 m, and 84 m) located in the expected airshed at Soaproot Saddle. Details of how the airshed was determined are provided below. Soil temperature was measured with platinum resistance temperature sensors (RTD 810, Omega Engineering Inc., Stamford CT) and soil moisture was measured with time domain dielectric sensors (CS616, Campbell Scientific Inc., Logan UT).

As well as measuring soil temperature and moisture at each sample point in Figure 27, measurements were also taken 30 cm in front and behind the sampling point along the axis of the transect. For example, at the 2 m sampling point, soil temperature and moisture was measured at 1.7 m, 2 m, and 2.3 m; this data is referred to as mobile data, since the measurements were taken at many different locations. In addition, soil temperature and moisture were continuously recorded at a single fixed location (stationary data) throughout the sampling time to correct for changes in temperature and moisture throughout the day.

Title: D17 FIU Site Characterization: Supporting Data	Author: Luo/ Ayres/Loescher	Date: 09/26/2011
NEON Doc. #: NEON.DOC.011077		Revision: B

Data collected were used for geospatial analyses of variograms in the R statistical computing language with the geoR package to test for spatial autocorrelation (Trangmar *et al.* 1986; Webster & Oliver 1989; Goovaerts 1997; Riberiro & Diggle 2001) and estimate the distance necessary for independence among soil plots in the soil array. To correct for changes in temperature and moisture over the sampling period, the stationary data was subtracted from the mobile data. In many instances a time of day trend was still apparent in the data even after subtracting the stationary data from the mobile data. This time of day trend was corrected for by fitting a linear regression and using the residuals for the semivariogram analysis. Soil temperature and moisture data, R code, graphs, and R output can be found at: P:\FIU\FIU_Site_Characterization\DXX\YYYYYYY_Characterization\Soil Measurements\Soil Data Analysis (where XX = domain number and YYYYYYY = site name).

4.3.3 Results and interpretation

4.3.3.1 Soil Temperature

Soil temperature data residuals, after accounting for changes in temperature in the stationary data, any remaining time of day trend, and elevation, aspect, and slope trends, were used for the semivariogram analysis (Figure 28). Exploratory data analysis plots show that there was no distinct patterning of the residuals (Figure 29, left graph) and directional semivariograms do not show anisotropy (Figure 29, center graph). An isotropic empirical semivariogram was produced and a spherical model was fitted using Cressie weights (Figure 29, right graph). The model indicates a distance of effective independence of 9 m for soil temperature.

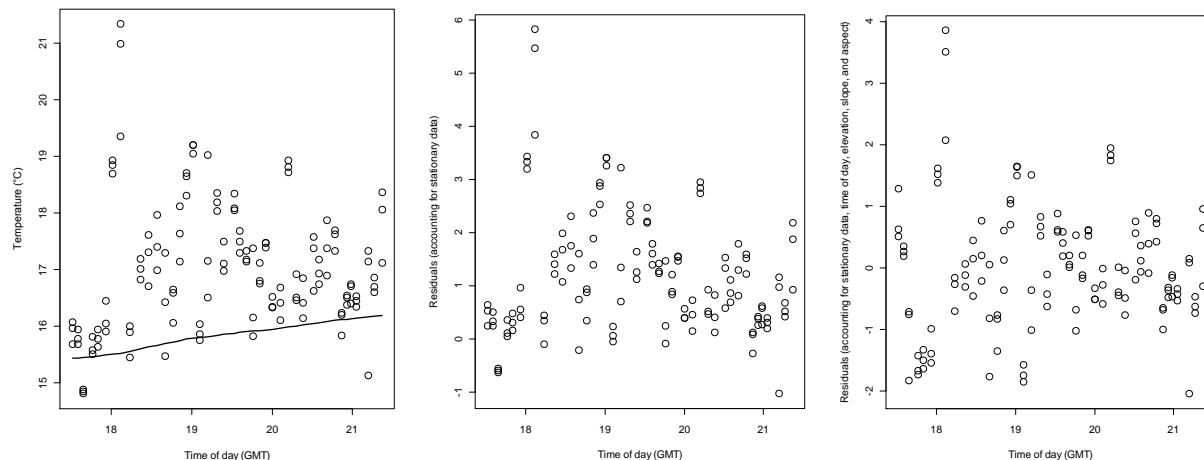

Figure 28. Left graph: mobile (circles) and stationary (line) soil temperature data. Center graph: temperature data after correcting for changes in temperature in the stationary data (circles) and a linear regression based on time of day (line). Right graph: residual temperature data after correcting for changes temperature in the stationary data and the time of day regression. Data in the right graph were used for the semivariogram analysis.

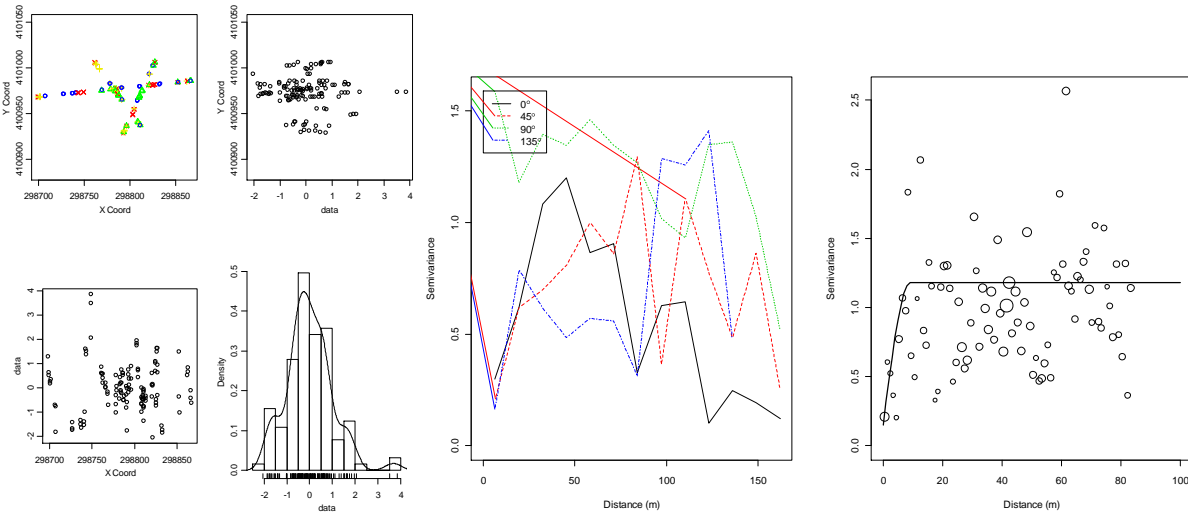

Figure 29. Left graphs: exploratory data analysis plots for residuals of temperature. Center graph: directional semivariograms for residuals of temperature. Right graph: empirical semivariogram (circles) and model (line) fit to residuals of temperature.

4.3.3.2 Soil water content

Soil water content data residuals, after accounting for changes in water content in the stationary data, any remaining time of day trend, and elevation, aspect, and slope trends, were used for the semivariogram analysis (Figure 30). Exploratory data analysis plots show that there was no distinct patterning of the residuals (Figure 31, left graph) and directional semivariograms do not show anisotropy (Figure 31, center graph). An isotropic empirical semivariogram was produced and a spherical model was fitted using Cressie weights (Figure 31, right graph). The model indicates a distance of effective independence of 3 m for soil water content.

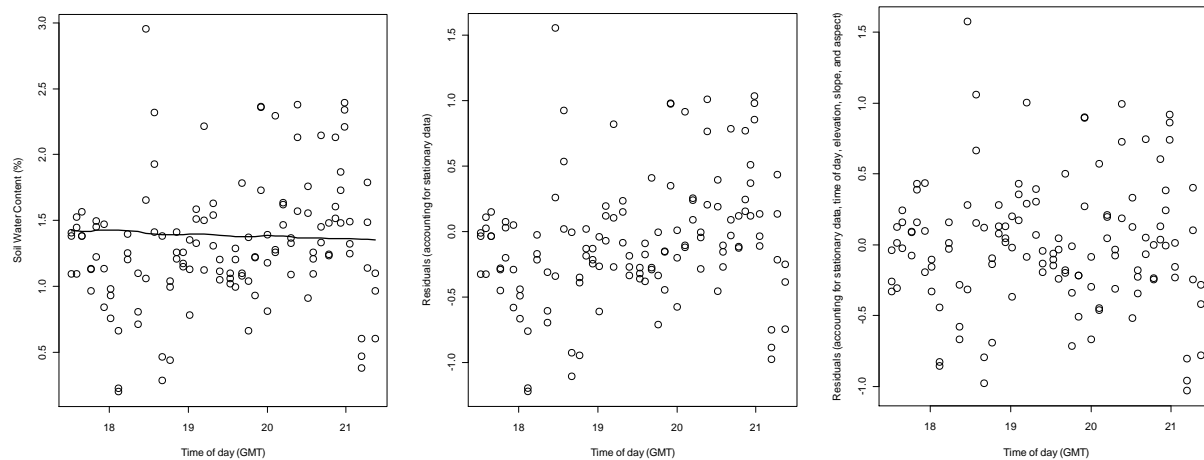

Figure 30. Left graph: mobile (circles) and stationary (line) soil water content data. Center graph: water content data after correcting for changes in water content in the stationary data (circles) and a linear

regression based on time of day (line). Right graph: residual water content data after correcting for changes water content in the stationary data and the time of day regression. Data in the right graph were used for the semivariogram analysis.

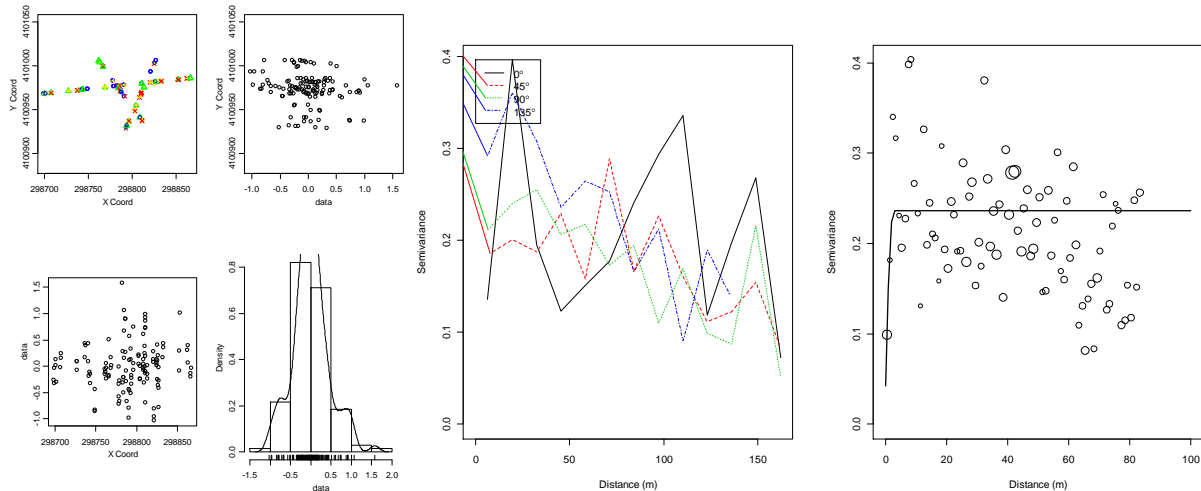

Figure 31. Left graphs: exploratory data analysis plots for residuals of soil water content. Center graph: directional semivariograms for residuals of water content. Right graph: empirical semivariogram (circles) and model (line) fit to residuals of water content.

4.3.3.3 Soil array layout and soil pit location

The minimum distance allowable between soil plots is 25 m to ensure a degree of spatial independence in non-measured soil parameters (i.e., other than temperature and water content) and the maximum distance allowable between soil plots is 40 m due to cost constraints. The estimated distance of effective independence was 9 m for soil temperature and 3 m for soil moisture. Based on these results and the site design guidelines the soil plots at Soaproot Saddle shall be placed 25 m apart. The soil array shall follow the linear soil array design (Soil Array Pattern B) with the soil plots being 5 m x 5 m. The direction of the soil array shall be 80° from the soil plot nearest the tower (i.e., first soil plot). The location of the first soil plot will be approximately 37.033436, -119.261981. The exact location of each soil plot may be microsited to avoid placing a soil plot at an unrepresentative location (e.g., rock outcrop, drainage channel, large tree, etc). The FIU soil pit for characterizing soil horizon depths, collecting soil for site-specific sensor calibration, and collecting soil for the FIU soil archive will be located at 37.031153°, -119.259330° (primary location); or 37.031357°, -119.259921° (alternate location 1 if primary location is unsuitable); or 37.031695°, -119.260610° (alternate location 2 if primary location is unsuitable). A summary of the soil information is shown in Table 10 and site layout can be seen in Figure 32.

Dominant soil series at the site: Holland Family, 35 to 65 percent slopes. The taxonomy of this soil is shown below:

Order: Alfisols

Suborder: Xeralfs

Great group: Haploxeralfs

Title: D17 FIU Site Characterization: Supporting Data	Author: Luo/ Ayres/Loescher	Date: 09/26/2011
NEON Doc. #: NEON.DOC.011077		Revision: B

Subgroup: Ultic Haploxeralfs

Family: Fine-loamy, mixed, semiactive, mesic Ultic Haploxeralfs

Series: Holland Family, 35 to 65 percent slopes

Table 10. Summary of soil array and soil pit information at Soaproot Saddle. 0° represents true north and accounts for declination.

Soil plot dimensions	5 m x 5 m
Soil array pattern	B
Distance between soil plots: x	25 m
Distance from tower to closest soil plot: y	20 m
Latitude and longitude of 1 st soil plot OR direction from tower	37.033436, -119.261981
Direction of soil array	80°
Latitude and longitude of FIU soil pit 1	37.031153°, -119.259330° (primary location)
Latitude and longitude of FIU soil pit 2	37.031357°, -119.259921° (alternate 1)
Latitude and longitude of FIU soil pit 3	37.031695°, -119.260610° (alternate 2)
Dominant soil type	Holland Family, 35 to 65 percent slopes
Expected soil depth	1.68 to 1.78 m
Depth to water table	>2 m

Expected depth of soil horizons	Expected measurement depths*
0-0.18 m (Sandy loam)	0.09 m [†]
0.18-1.52 m (Sandy clay loam)	0.85 m [†]
1.52-1.68 m (Sandy loam)	1.60 m [†]
1.68-1.78 m (Weathered bedrock)	1.73 m
1.78 m	1.78 m

* Actual soil measurement depths will be determined based on measured soil horizon depths at the NEON FIU soil pit and may differ substantially from those shown here.

[†] Expected soil CO₂ sensor depths

Title: D17 FIU Site Characterization: Supporting Data	Author: Luo/ Ayres/Loescher	Date: 09/26/2011
NEON Doc. #: NEON.DOC.011077		Revision: B

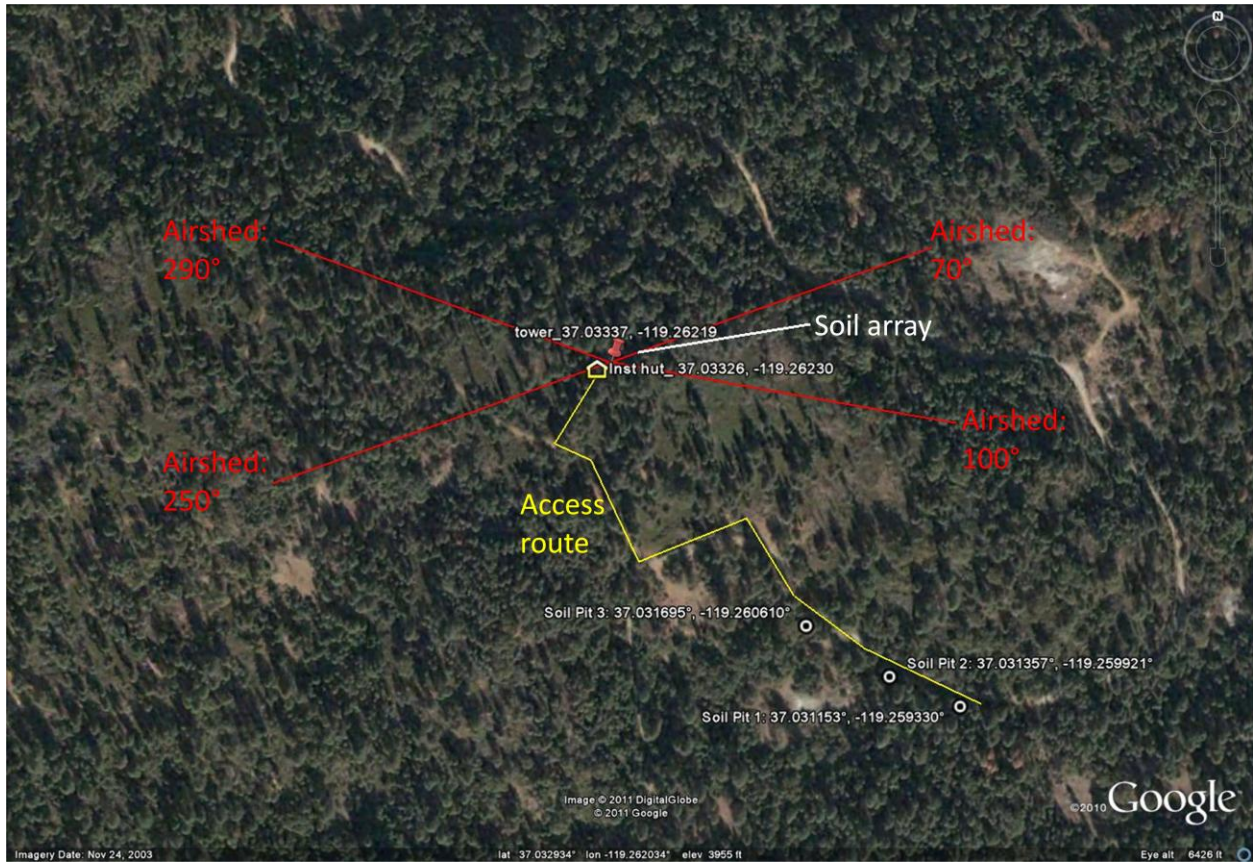

Figure 32. Site layout at Soaproot Saddle showing soil array and location of the FIU soil pit.

4.4 Airshed

4.4.1 Seasonal windroses

Wind roses analytically determine and graphically represent the frequencies of wind direction and wind speed over a given timeseries. The weather data used to generate the following wind roses are 2007-2009 data from MesoWest weather station FENCE MEADOW (ID: FNWC1, Lat: 36.9614, Long: -119.1750), which is ~6.9 miles to tower site. This is the closest weather station that has available wind data we can use. Due to the complex mountain topography and terrain, it is possible that the wind patterns at NEON site are actually different with the pattern presented below. Wind patterns need to be reassessed with > 1 year on site wind data after construction. The orientation of the wind rose follows that of a compass (assume declination applied). When we describe the wind directions it should be noted that they are the cardinal direction that wind blows from. The directions of the rose with the longest spoke show wind directions with the largest frequency. These wind roses are subdivided into as 24 cardinal directions.

4.4.2 Results (graphs for wind roses)

Title: D17 FIU Site Characterization: Supporting Data	Author: Luo/ Ayres/Loescher	Date: 09/26/2011
NEON Doc. #: NEON.DOC.011077		Revision: B

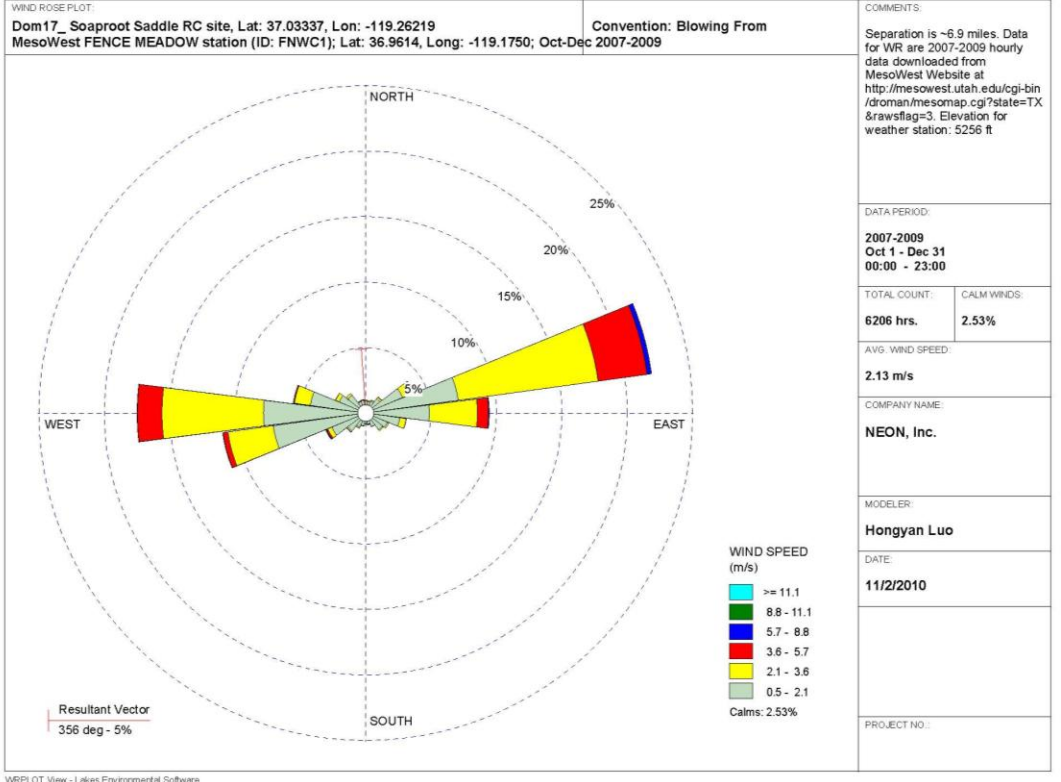
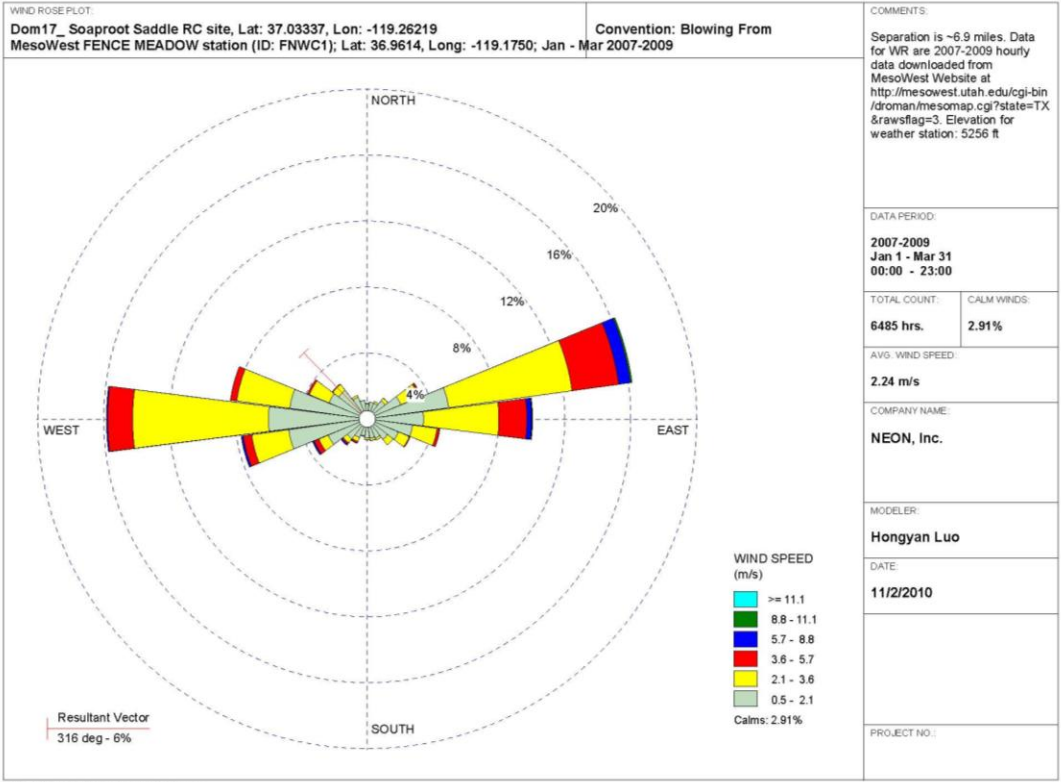

Title: D17 FIU Site Characterization: Supporting Data	Author: Luo/ Ayres/Loescher	Date: 09/26/2011
NEON Doc. #: NEON.DOC.011077		Revision: B

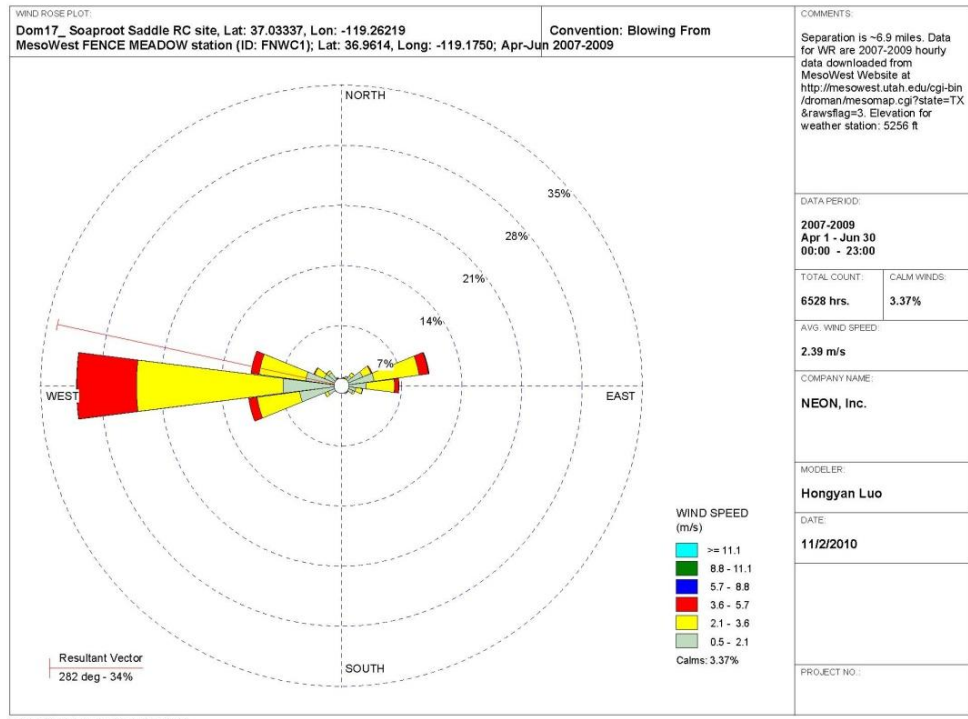
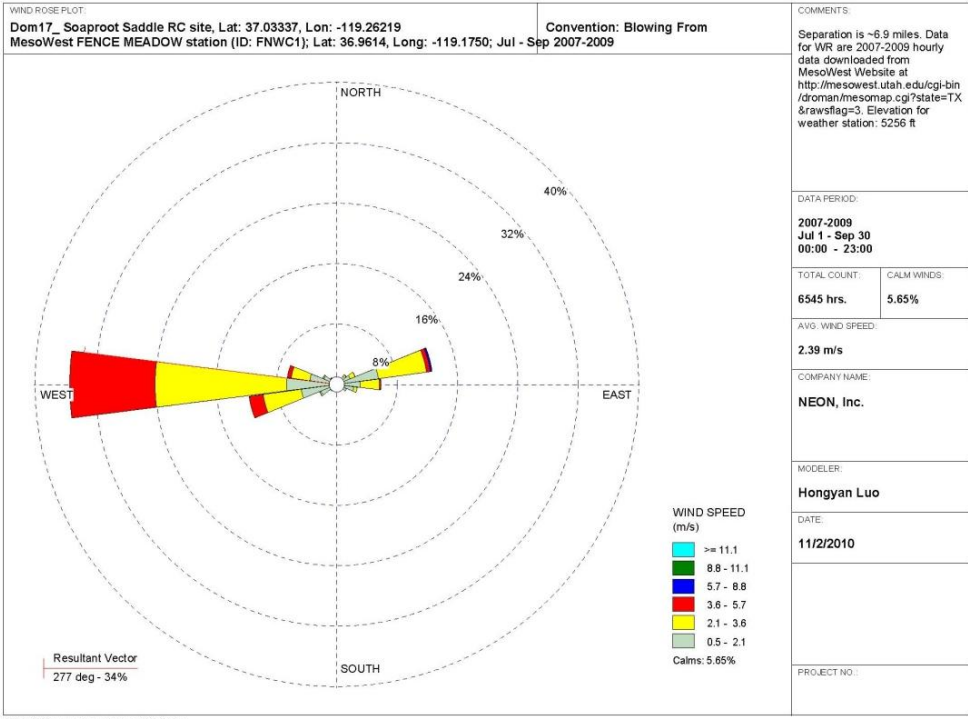

Figure 33. Windroses for Soaproot Saddle Relocatable site. The weather data used to generate the following wind roses are 2007-2009 data from MesoWest weather station FENCE MEADOW (ID: FNWC1, Lat: 36.9614, Long: -119.1750), which is ~6.9 miles to tower site. Panels are (from top to bottom) Jan-Mar, Apr-Jun, Jul-Sept, and Oct-Dec.

4.4.3 Resultant vectors

Table 11. The resultant wind vectors from Klemme using hourly data in 2007.

Quarterly (seasonal) timeperiod	Resultant vector	% duration
January to March	316°	6
April to June	282°	34
July to September	277°	34
October to December	356°	5
Annual mean	307.75°	na.

4.4.4 Expected environmental controls on source area

Two types of models were commonly used to determine the shape and extent of the source area under different and contrasting atmospheric stability classes. An inverted plume dispersion model with modeled cross wind solutions were used for convective conditions (Horst and Weil 1994). For strongly stable conditions, and Lagrangian solution was used (Kormann and Meixner 2001). The source area models where bounded by the expected conditions depict the extreme conditions. Convective conditions typically have strong vertical mixing between the ecosystem and atmosphere (surface layer). Stable conditions typically have long source area and associated waveforms. Convective turbulence is often characterized by short mixing scales (scalar) and moderate daytime wind speeds, *e.g.*, 1-4 m s⁻². Higher wind speeds, like those experienced over the Rockies, are often the product of mechanical turbulence with long waveforms. Because thermal stratification is very efficient in suppressing vertical mixing, stable conditions also have typically very long waveforms.

As a general rule, shorter and less structurally complex ecosystems have good vertical mixing during all atmospheric stabilities. Taller and more structurally complex ecosystems have well mixed upper canopies during the daytime, and can be decoupled below the canopy under neutral and stable conditions (*e.g.*, Harvard Forest, Bartlett Experimental Forest, and Burlington Conservation Area). The type of turbulence (mechanical verse convective) and the physical attributes of the ecosystem control the degree of mixing, and the length and size of the source area.

Here, we use a web-based footprint model to determine the footprint area under various conditions (model info: <http://www.geos.ed.ac.uk/abs/research/micromet/EdiTools/>). Winds used to run the model and generate following model results are extracted from the wind roses. Vegetation information, temperature and energy information were either from the RFI document, previous site visit report, available data files or best estimated from experienced expert. Measurement height was determined from the Tower Height requirements (NEON.FI.3.302, NEON.FI.3.303) and reported in Info document provided by ENG group, then verify according to the real ecosystem structure after FIU site characterization at site. Runs 1-3 and 4-6 represent the expected conditions for summer and winter conditions, respectively, with maximum and mean windspeeds (daytime convective) and nighttime (stable atmospheres) conditions. The wind vector for each run was estimated from wind roses and is placed as a centerline in the site map included in the graphics. The width of the footprint was also estimated using the length between the isopleth of 80% cumulative flux and center line to calculate the angle from centerline. This information, along with distance of the cumulative flux isopleths and wind direction, will define the source area for the flux measurements on the top of the tower.

Table 12. Expected environmental controls to parameterize the source area model and associated results from Soaproot Saddle tower site.

Parameters	Run 1	Run 2	Run 3	Run 4	Run 5	Run 6	
Approximate season	summer			winter			Units
	Day (max WS)	Day (mean WS)	Night	Day (max WS)	Day (mean WS)	night	qualitative
Atmospheric stability	Convective	convective	Stable	Convective	convective	Stable	qualitative
Measurement height	50	50	50	50	50	50	m
Canopy Height	32	32	32	32	32	32	m
Canopy area density	3	3	3	2.5	2.5	2.5	m
Boundary layer depth	3500	3500	1800	1500	1500	1000	m
Expected sensible heat flux	650	650	175	300	300	50	W m ⁻²
Air Temperature	34	34	22	22	22	17	°C
Max. windspeed	5.6	2.6	1.6	5.6	2.6	1.6	m s ⁻¹
Resultant wind vector	75	75	270	75	75	270	degrees
Results							
(z-d)/L	-0.2	-0.37	-0.38	-0.11	-0.37	-0.35	m
d	25	25	25	25	25	25	m
Sigma v	3	2.8	1.6	2.3	1.8	1	m ² s ⁻²
Z0	1.4	1.4	1.4	1.6	1.6	1.6	m
u*	0.95	0.77	0.5	0.91	0.61	0.34	m s ⁻¹
Distance source area begins	0	0	0	0	0	0	m
Distance of 90% cumulative flux	750	250	250	950	400	490	m
Distance of 80% cumulative flux	480	200	200	550	250	300	m
Distance of 70% cumulative flux	300	150	150	400	200	200	m
Peak contribution	85	35	25	105	45	55	m

4.4.5 Results (source area graphs)

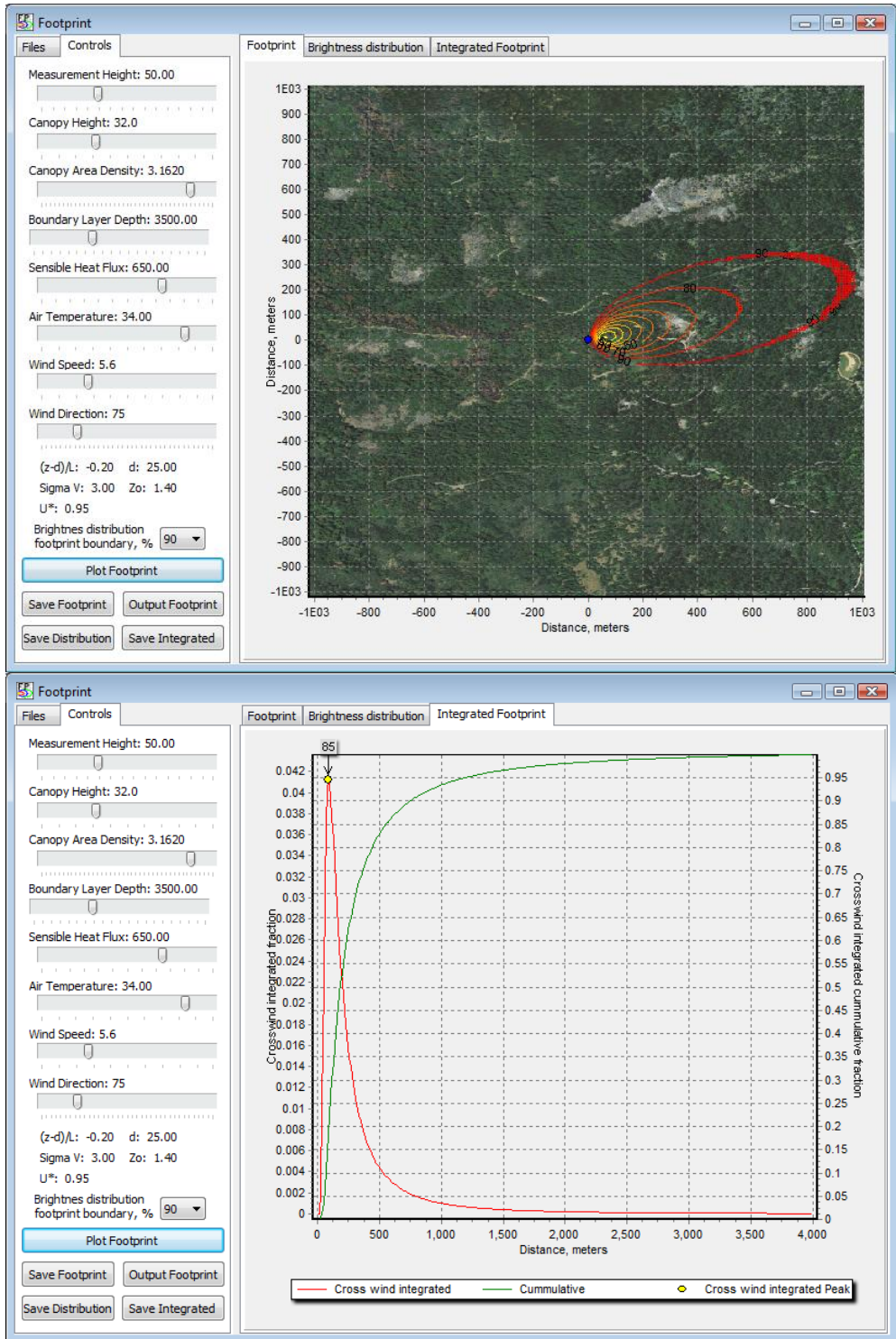

Figure 34. Soaproot Saddle Relocatable site summer daytime (convective) footprint output with max wind speed

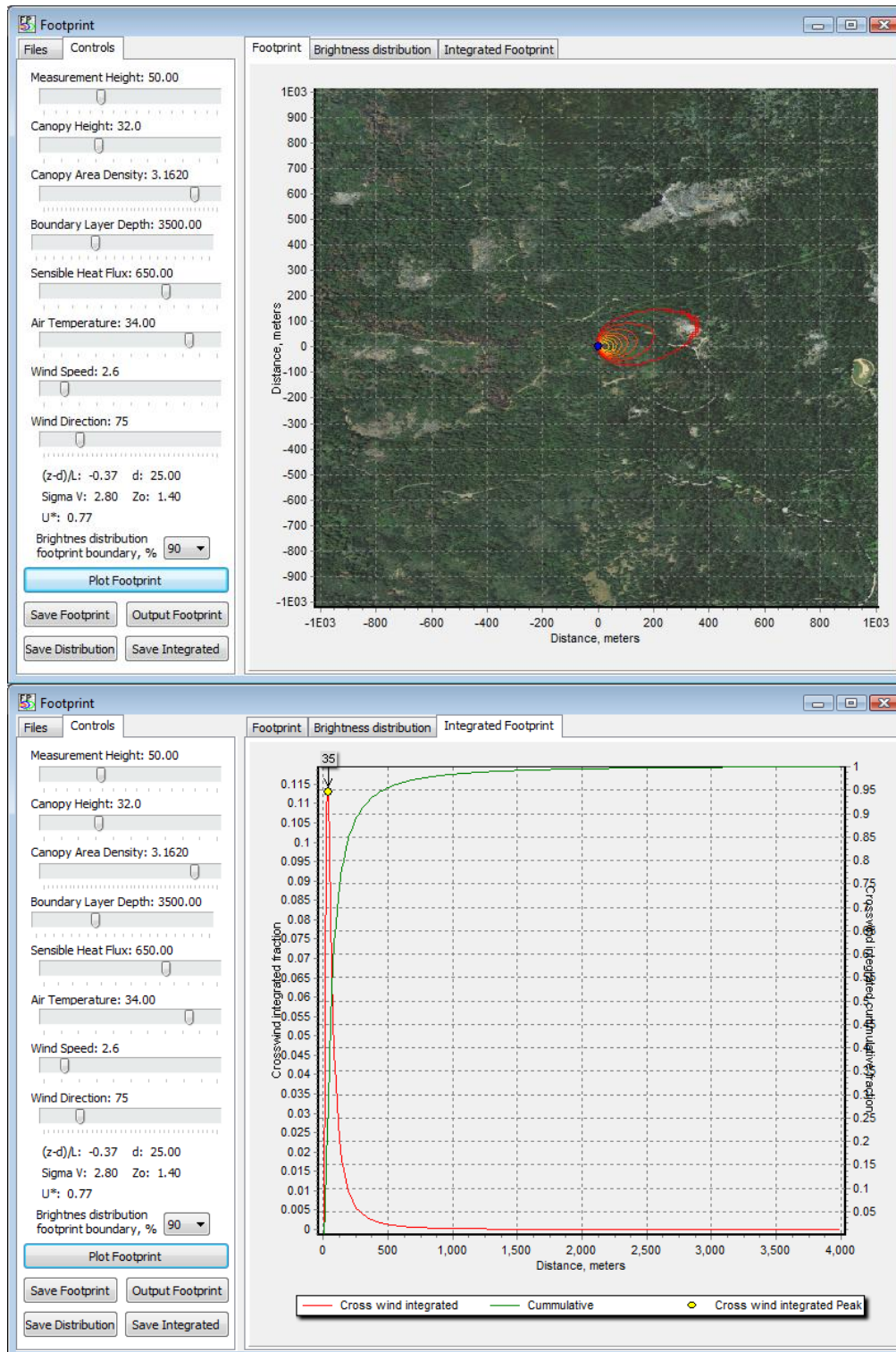

Figure 35. Soaproot Saddle Relocatable site summer daytime (convective) footprint output with mean wind speed

Title: D17 FIU Site Characterization: Supporting Data	Author: Luo/ Ayres/Loescher	Date: 09/26/2011
NEON Doc. #: NEON.DOC.011077		Revision: B

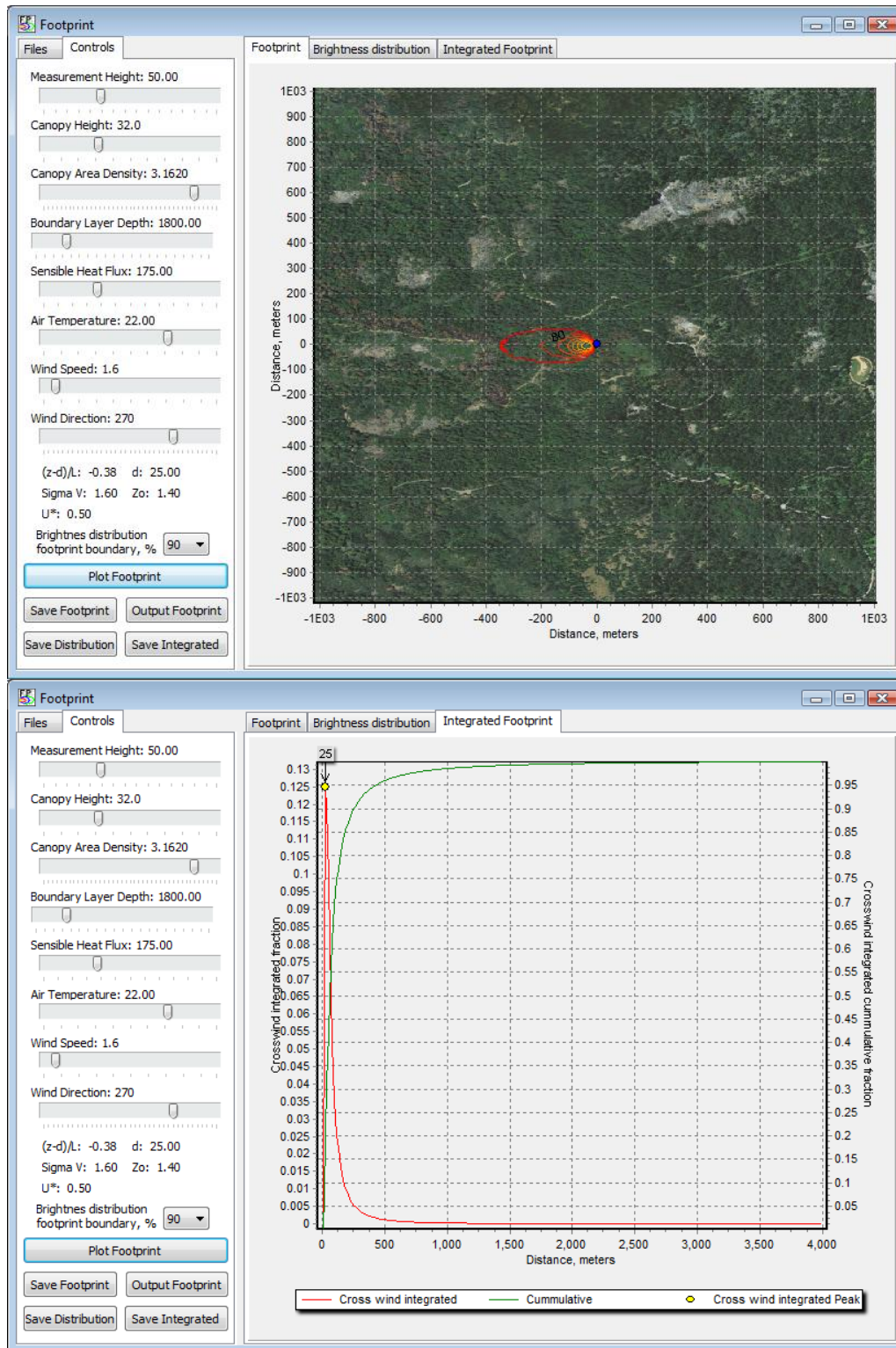

Figure 36. Soaproot Saddle Relocatable site summer nighttime (stable) footprint output with mean wind speed.

Title: D17 FIU Site Characterization: Supporting Data	Author: Luo/ Ayres/Loescher	Date: 09/26/2011
NEON Doc. #: NEON.DOC.011077		Revision: B

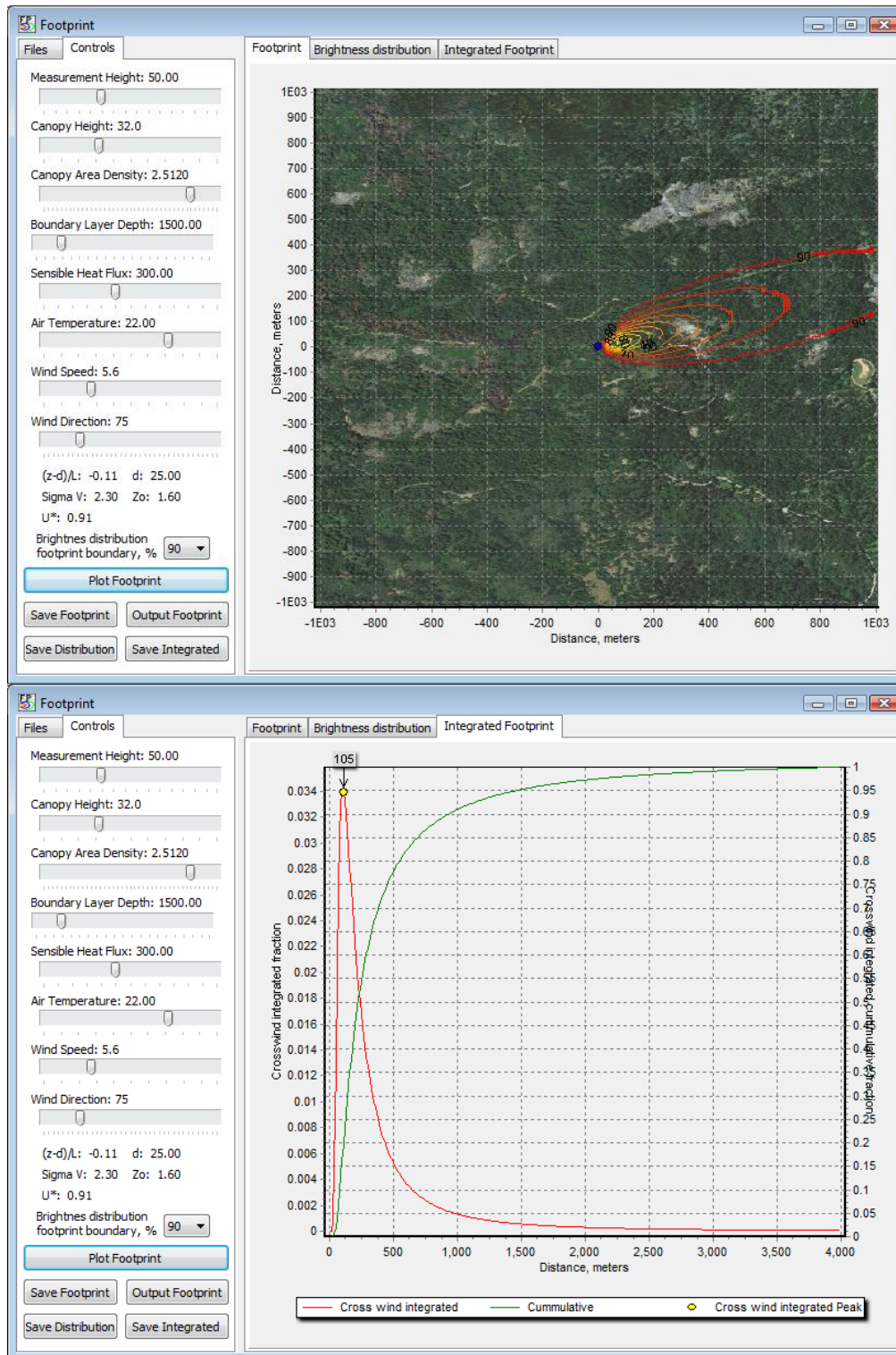

Figure 37. Soaproot Saddle Relocatable site winter daytime (convective) footprint output with max wind speed

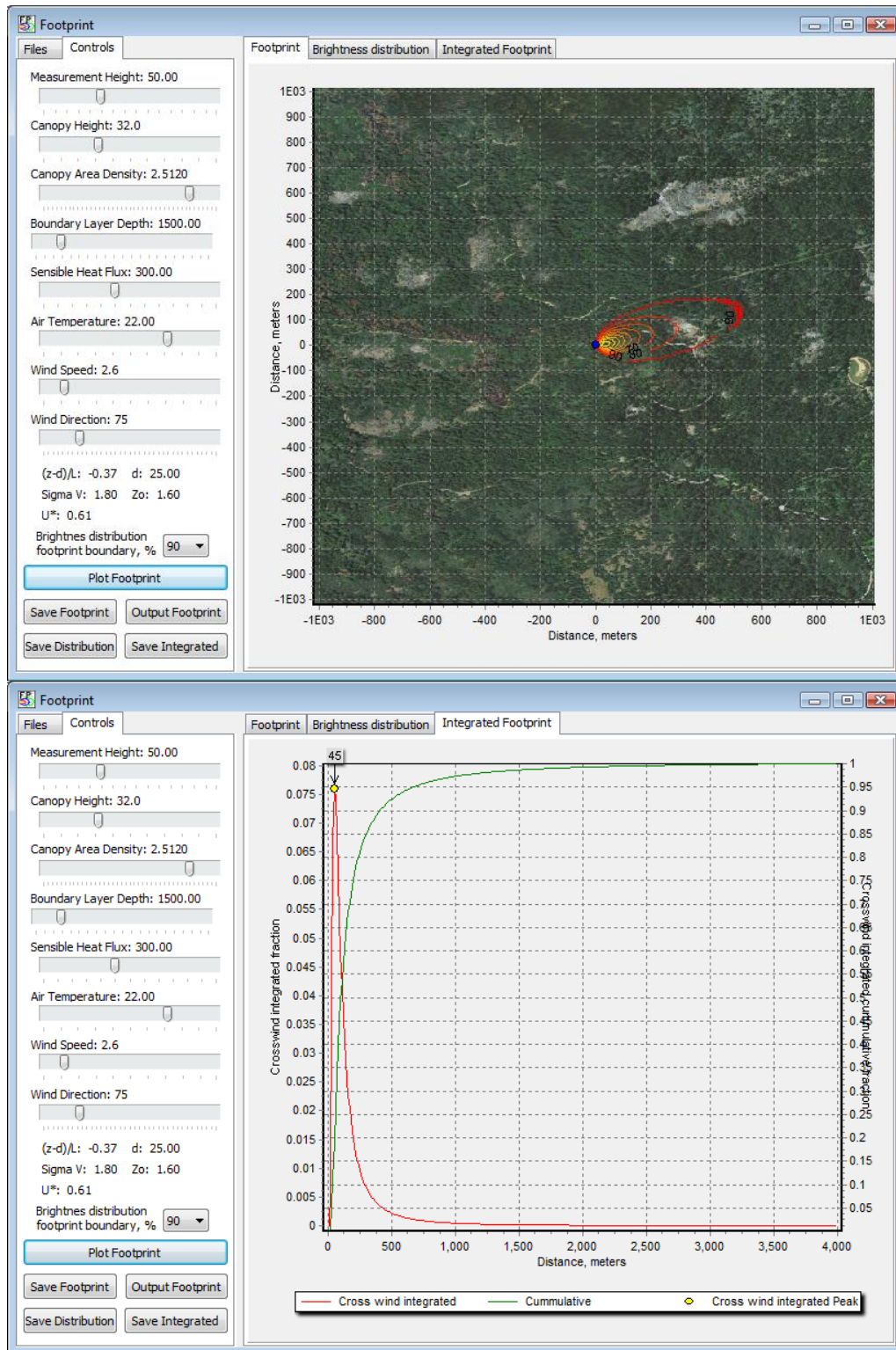

Figure 38. Soaproot Saddle Relocatable site winter daytime (convective) footprint output with mean wind speed

Title: D17 FIU Site Characterization: Supporting Data	Author: Luo/ Ayres/Loescher	Date: 09/26/2011
NEON Doc. #: NEON.DOC.011077		Revision: B

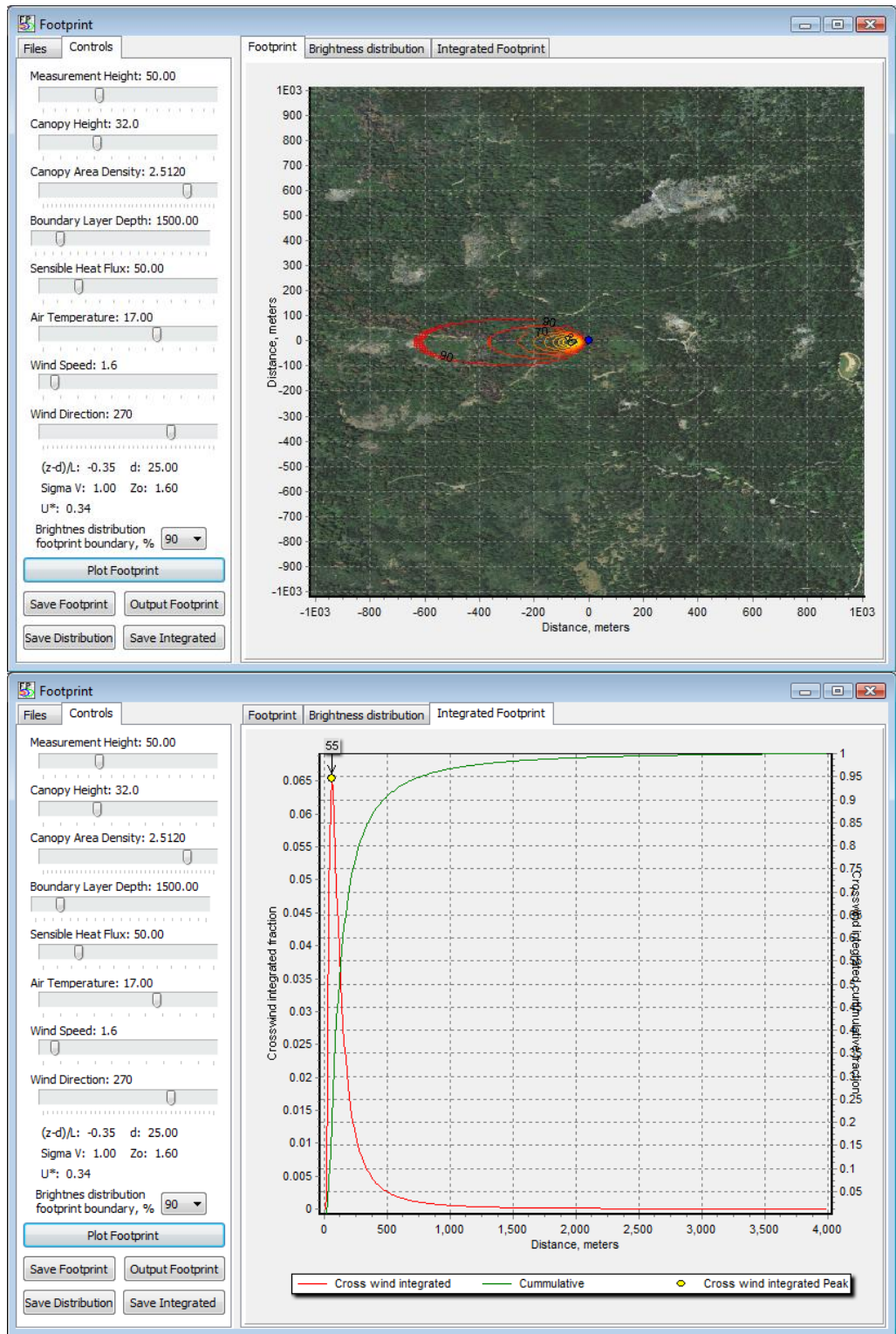

Figure 39. Soaproot Saddle Relocatable site winter nighttime (stable) footprint output with mean wind speed

Title: D17 FIU Site Characterization: Supporting Data	Author: Luo/ Ayres/Loescher	Date: 09/26/2011
NEON Doc. #: NEON.DOC.011077		Revision: B

4.5 Site design and tower attributes

According to wind roses, prevailing wind blows from east (70° to 100°, clockwise from 70°) and from west (250° to 290°, clockwise from 250°). The weather data used to generate these wind roses are 2007-2009 data from MesoWest weather station FENCE MEADOW (ID: FNWC1, Lat: 36.9614, Long: -119.1750), which is ~6.9 miles from the tower site. This is the closest weather station that has available wind data we can use. Due to the complex mountain topography and terrain, it is possible that the wind patterns at NEON site are actually different with the wind roses here. Wind patterns need to be reassessed with > 1 year on site wind data after measurements are established, and adjust boom orientation if necessary. For the current design, **tower** should be placed to a location, according to the current understanding, to best catch the signals from the airshed of the ecosystem in interest, which is ponderosa pine dominant open forest at this site. Original site 37.031069, -119.256431 was too far away from power. After FIU site characterization we microsited tower location toward northwest for ~ 600 m. New tower location is 37.03337, -119.26219, which is only ~ 110 m from power line.

Eddy covariance, sonic wind and air temperature **boom arms** orientation toward the north will be best to capture signals from all major wind directions. **Radiation boom arms** should always be facing south to avoid any shadowing effects from the tower structure. An **instrument hut** should be outside the prevailing wind airshed to avoid disturbance in the measurements of wind and should be positioned to have the longer side parallel to frequent wind direction to minimize the wind effects on instrument huts and to minimize the disturbances of wind regime by instrument hut, and in this case, instrument hut should be positioned on the southwest toward tower and have the longer side parallel to E-W direction. Therefore, we decide the placement of instrument hut at 37.03326, -119.26230.

Ecosystem at this site is a naturally regenerated stand with a mix of ponderosa and sugar pines, incense cedar, sequoia and redwood and some white fir. Dominant trees are ponderosa pine ~32 m in height. Canopy is open Lowest branch level is at ~ 8-9 m in height. Ground cover is predominantly sage with height ~0.3 -1 m. Punctuated in the area are patches of various sizes of oak and madrone with height ~ 4-6 m. Therefore, we require 6 **measurement layers** on the tower with top measurement height at 50 m, and the remaining levels are 36 m, 30 m, 18 m, 6 m and 0.3 m, respectively, to best characterize the fluxes on the tower top and environmental conditions in profile.

Secondary **precipitation collector** for bulk precipitation collection will be located the top of tower at this site. No **wet deposition collector** will be deployed at this site. See AD 04 for further information and requirements for bulk precipitation collection and wet deposition collection.

The site layout is summarized in the table below. Assume the projected area of the tower is square. **Anemometer/temperature boom arm direction** is *from* the tower *toward* the prevailing wind direction or designated orientation. **Instrument hut orientation vector** is parallel to the long side of the instrument hut. **Instrument hut distance z** is the distance from the center of tower projection to the center of the instrument hut projection on the ground. The numbering of the **measurement levels** is that the lowest is level one, and each subsequent increase in height is numbered sequentially.

Table 13. Site design and tower attributes for Soaproot Saddle Relocatable site

Title: D17 FIU Site Characterization: Supporting Data	Author: Luo/ Ayres/Loescher	Date: 09/26/2011
NEON Doc. #: NEON.DOC.011077		Revision: B

0° is true north with declination accounted for. Color of Instrument hut exterior shall be tan or best match the surrounding environment.

Attribute	lat	long	degree	meters	notes
Airshed area			70° to 100° and 250° to 290°		Clockwise from first angle
Tower location	37.03337,	-119.26219	--	--	new site
Instrument hut	37.03326,	-119.26230			
Instrument hut orientation vector	--	--	90° - 270°		longwise
Instrument hut distance z	--	--	--	16	
Anemometer/Temperature boom orientation	--	--	360°	--	
Height of the measurement levels					
Level 1				0.3	m.a.g.l.
Level 2				6.0	m.a.g.l.
Level 3				18.0	m.a.g.l.
Level 4				30.0	m.a.g.l.
Level 5				36.0	m.a.g.l.
Level 6				50.0	m.a.g.l.
Tower Height				50.0	m.a.g.l.

See AD 03 for technical requirement to determine the boom height for the bottom most measurement level.

Figure below shows the proposed tower location, instrument hut location, airshed area and access road.

Title: D17 FIU Site Characterization: Supporting Data	Author: Luo/ Ayres/Loescher	Date: 09/26/2011
NEON Doc. #: NEON.DOC.011077		Revision: B

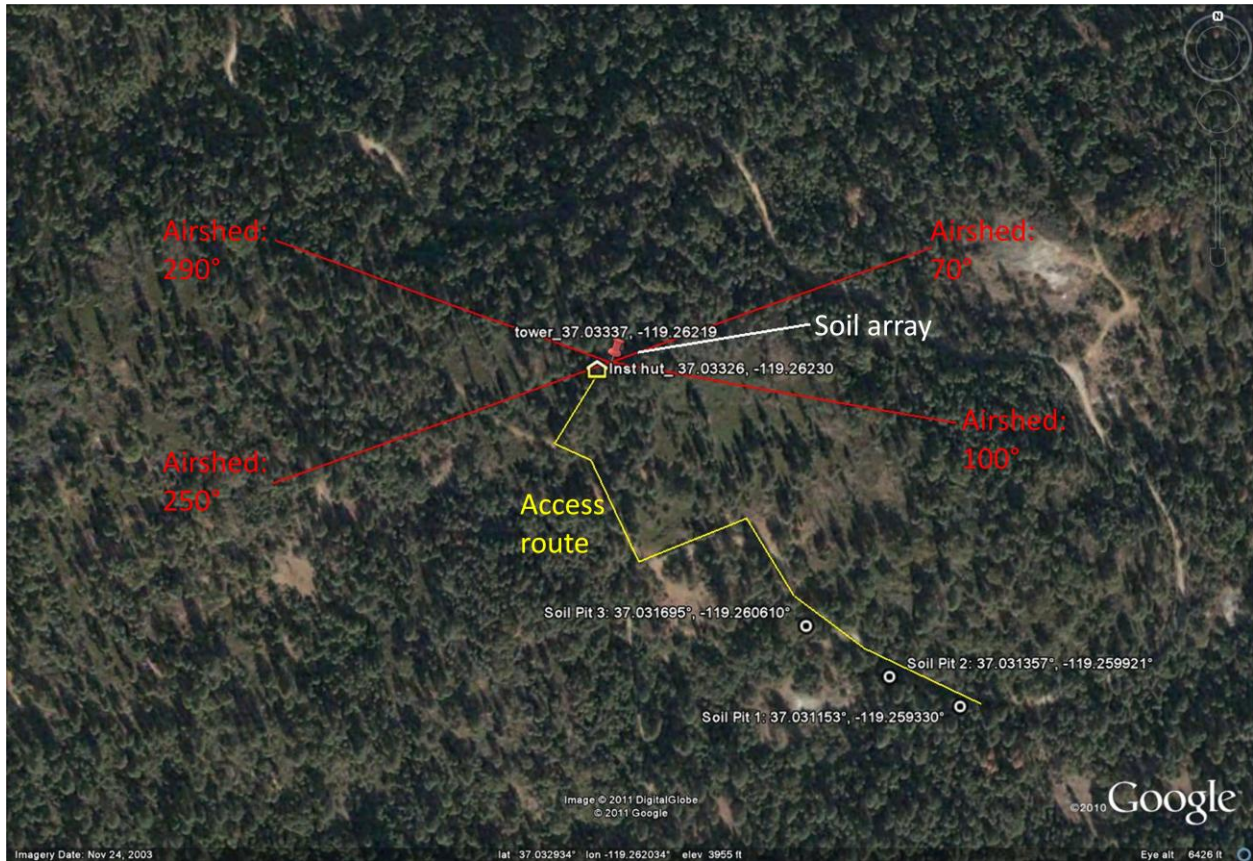

Figure 40. Site layout for Soaproot Relocatable site.
 i) tower location is presented (red pin), ii) red lines indicate the airshed boundaries. Vectors 70° to 100° (clockwise from 70°) and 250° to 290° (clockwise from 250°) would have quality wind data without causing flow distortions, respectively. iii) Yellow line is the suggested access road to instrument hut.

Boardwalks. Ultimately, the decision to use a boardwalk will be, in part, based on owner’s preferences. There are strong science requirements that minimize site disturbance to the surrounding area, which will be difficult to manage over a 30-y period. Traffic control is key to minimizing the site disturbance. Confining foot traffic to boardwalks minimizes site impact; this is particularly true in places where wear caused by foot traffic becomes noticeable and grows. For example, in places with snow part of the year, worn footpaths tend to have low places that collect water, or places where the snow pack becomes uneven causing personnel to walk farther and farther around the sides of the original path, causing the path to grow in width. This is a very common phenomenon. Here FIU assumes that all conduits will be either buried, or placed inside the boardwalk such that it does not extend beyond the 36’ wide footprint. While the final design is not yet known, there are some general criteria that can be outlined. We assume that the boardwalk width is 36” (0.914 m). Material is not known, but must be fire proof, and in some locations the site is seasonally flooded and inundated with water. Boardwalks may also provide a scratching structure for grazing animals that in turn, would wear and unduly impact the site. Site by site evaluations must be done.

Specific boardwalks at this Relocatable site

- Boardwalk from the access point to the instrument hut, pending landowner decision. (lots of snow)

Title: D17 FIU Site Characterization: Supporting Data	Author: Luo/ Ayres/Loescher	Date: 09/26/2011
NEON Doc. #: NEON.DOC.011077		Revision: B

- Boardwalk from the instrument hut to the tower to intersect on north face of the tower
- Boardwalk to the soil array (lots of snow)
- No boardwalk to individual soil plots

The relative locations between tower, instrument hut and boardwalk can be found in the diagram below:

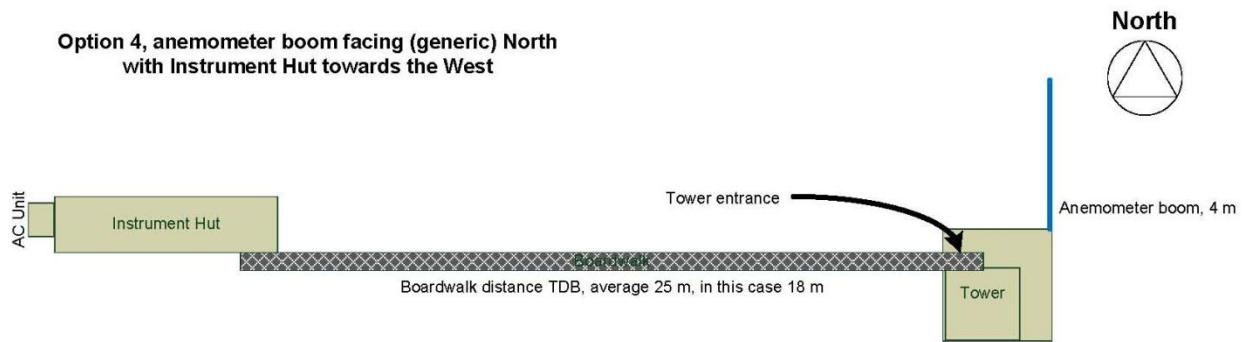

Figure 41. Generic diagram to demonstration the relationship between tower and instrument hut when boom facing north and instrument hut on the west towards the tower.

This is a generic diagram. The actual layout of boardwalk (or path if no boardwalk required) and instrument hut position will be the joint responsibility of FCC and FIU. At Soaproot Saddle Relocatable site, the boom angle will be 360° , instrument hut will be on the southwest towards the tower, the distance between instrument hut and tower is ~ 16 m. The instrument hut vector will be E-W (90° - 270° , longwise).

4.6 Information for ecosystem productivity plots

The tower at this site has been positioned to optimize the collection of the air/wind signals both temporally and spatially over the desired ecosystem (ponderosa pine dominant open forest). Prevailing wind blows from 70° to 100° (clockwise from 70°) and from 250° to 290° (clockwise from 250°). 90% signals for flux measurements are within a distance of 500 m from tower, and 80% within 300 m with mean wind speed, while can reach ~ 900 m and ~ 700 m, respectively, with maximum wind speed at this site. We suggest FSU Ecosystem Productivity plots are placed within the boundaries of 70° to 100° (clockwise from 70°) and 250° to 290° (clockwise from 250°) from tower.

4.7 Issues and attentions

The weather data used to generate the wind roses in this report are 2007-2009 data from MesoWest weather station FENCE MEADOW (ID: FNWC1, Lat: 36.9614, Long: -119.1750), which is ~ 6.9 miles to tower site. This is the closest weather station that has available wind data we can use. Due to the complex mountain topography and terrain, it is possible that the wind patterns at NEON site are actually different with the wind roses here. Wind patterns need to be reassessed with > 1 year on site wind data after measurements are established, and adjust boom orientation if necessary.

Title: D17 FIU Site Characterization: Supporting Data	Author: Luo/ Ayres/Loescher	Date: 09/26/2011
NEON Doc. #: NEON.DOC.011077		Revision: B

5 LOWER TEAKETTLE, RELOCATEABLE TOWER 2

5.1 Site description

NEON Upper Teakettle candidate Relocatable site was located at 36.975178°, -119.048428° (Figure 42). Because this site is too far away from power to be viable, we relocated the tower location ~3.2 miles toward northeast to 37.00583, -119.00602 (Figure 43). Because the elevation of this new location is lower than the original Upper Teakettle relocatable site, we call it Lower Teakettle relocatable site in this report.

The new site is located on an upper steppe (~2165 m), higher than Soaproot Saddle relocatable site. Topography in the immediate area is relatively flat with 3-5 m gentle rises and situated by large land forms. Granite outcrops are 30 -50 m in height and 5-10 km away. This is the flattest site we could find at this elevation. This is expected to receive 80% snow and 20% rain in the annual precipitation. The site is surrounded by roads on 2 adjacent sides (north and west), approximate 500 m away in either direction. Power is approximate 600 m away. Winter access is good and convenient. This site also has camping ground nearby, and may be frequently used by hunters.

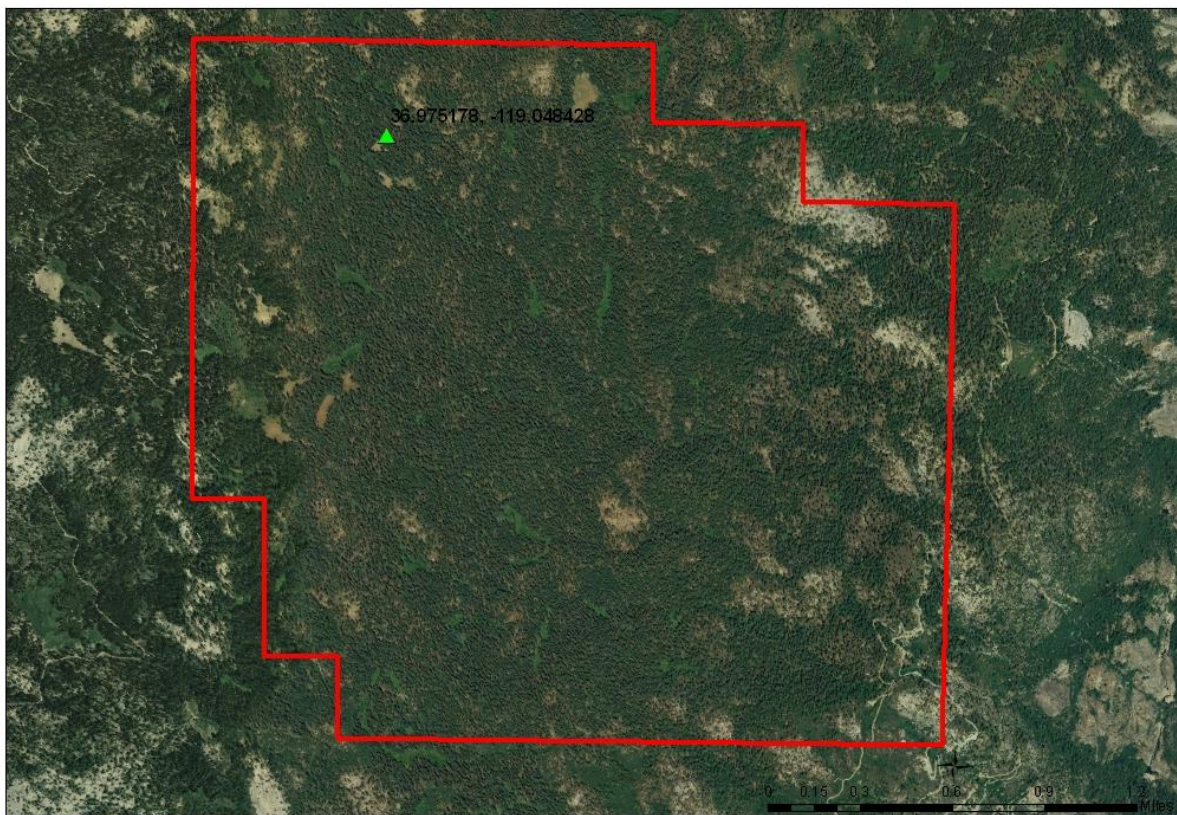

Domain 17 - Tea Kettle Creek



 NEON Candidate Location
 Tea kettle Creek Property Boundary

Figure 42. The boundary map and original Upper Teakettle candidate tower location. The tower location is now moved to Lower Teakettle site.

Title: D17 FIU Site Characterization: Supporting Data	Author: Luo/ Ayres/Loescher	Date: 09/26/2011
NEON Doc. #: NEON.DOC.011077		Revision: B

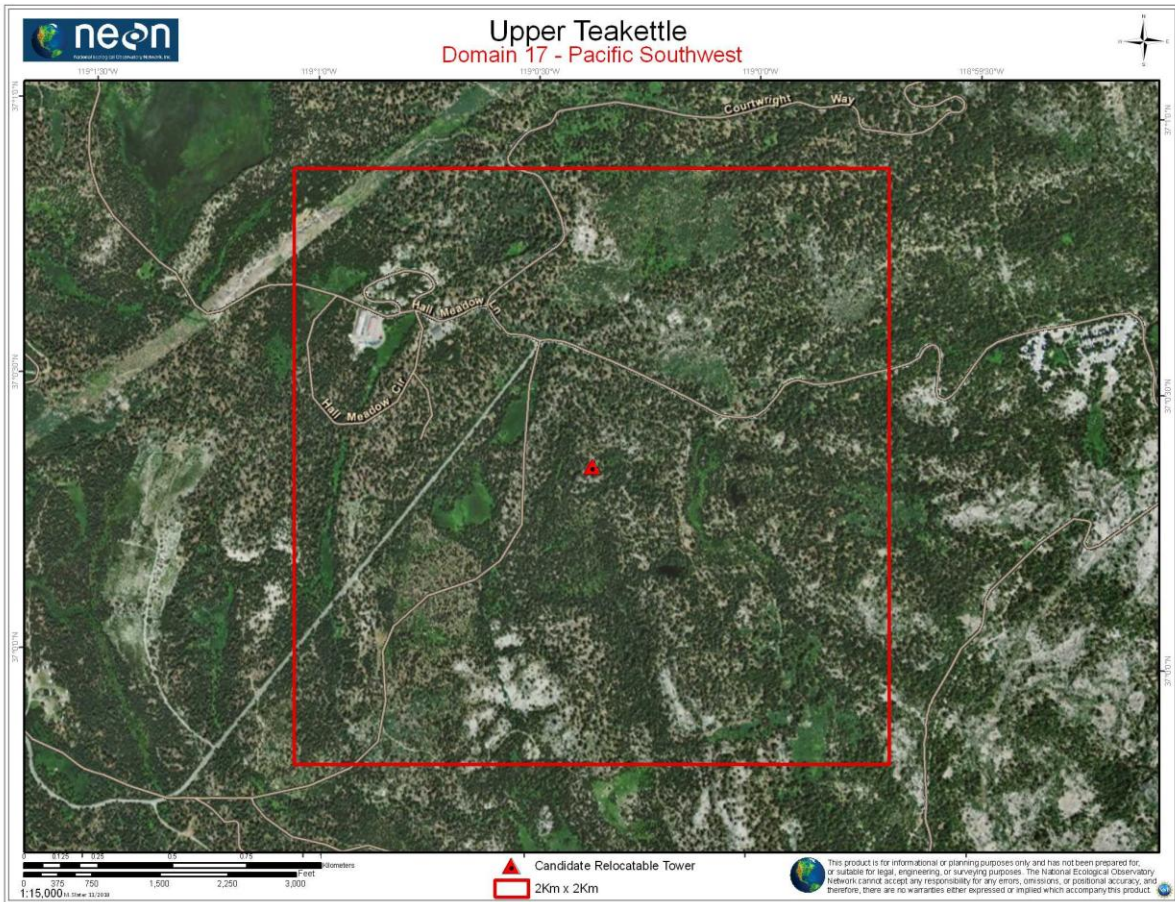

Figure 43. A map to indicate the new Lower Teakettle tower location.

5.2 Ecosystem

Vegetation and land cover around tower site and surrounding area are presented below:

Title: D17 FIU Site Characterization: Supporting Data	Author: Luo/ Ayres/Loescher	Date: 09/26/2011
NEON Doc. #: NEON.DOC.011077		Revision: B

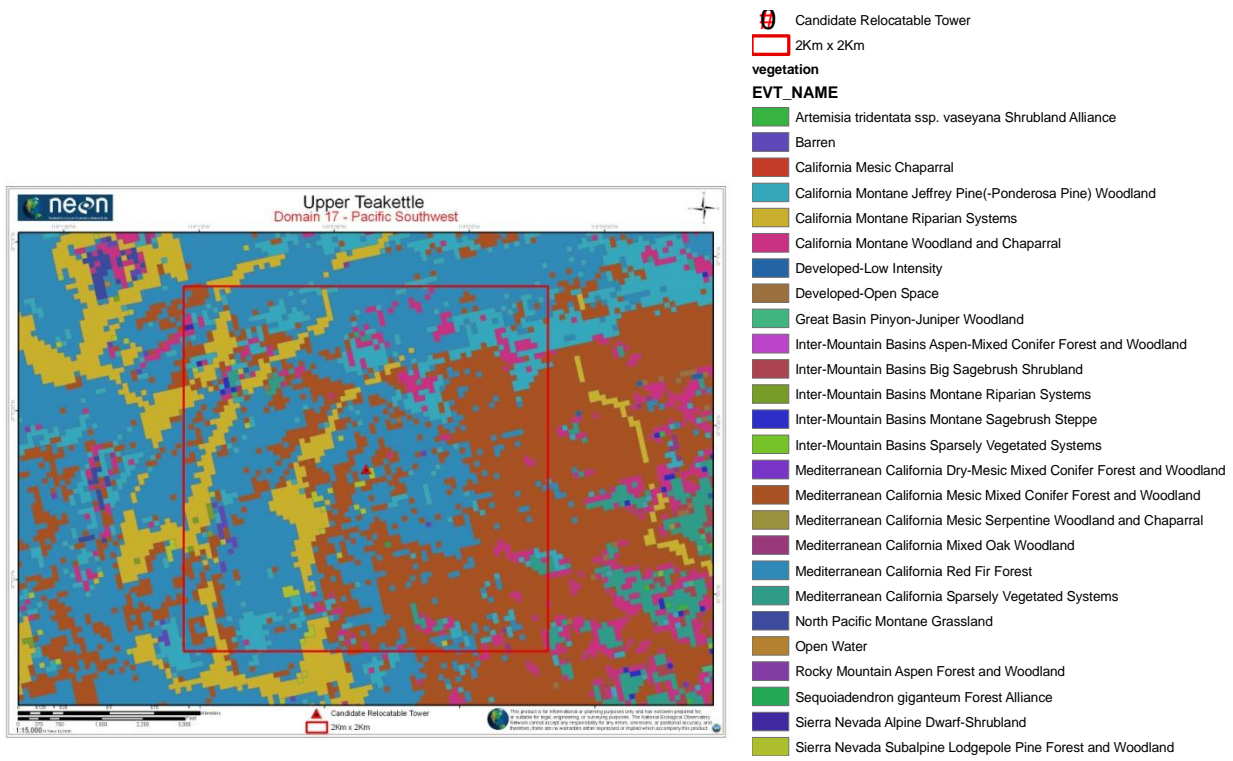

Figure 44. Vegetative cover map of the Lower Teakettle relocatable site and surrounding areas (from USGS, <http://landfire.cr.usgs.gov/viewer/viewer.htm>)

Table 14. Percent Land cover information at the Lower Teakettle relocatable site (from USGS, <http://landfire.cr.usgs.gov/viewer/viewer.htm>)

Vegetation_Type	Area_km ²	Percentage
Artemisia tridentata ssp. vaseyana Shrubland Alliance	0.00	0.02
Barren	0.02	0.38
California Montane Jeffrey Pine(-Ponderosa Pine) Woodland	0.38	9.52
California Montane Riparian Systems	0.35	8.64
California Montane Woodland and Chaparral	0.16	3.97
Developed-Low Intensity	0.00	0.02
Developed-Open Space	0.00	0.07
Inter-Mountain Basins Montane Riparian Systems	0.01	0.14
Inter-Mountain Basins Montane Sagebrush Steppe	0.00	0.09
Mediterranean California Mesic Mixed Conifer Forest and Woodland	1.41	35.21
Mediterranean California Mixed Oak Woodland	0.00	0.08
Mediterranean California Red Fir Forest	1.61	40.25
Mediterranean California Sparsely Vegetated Systems	0.03	0.82
Sequoiadendron giganteum Forest Alliance	0.00	0.02
Sierra Nevada Alpine Dwarf-Shrubland	0.00	0.06
Sierra Nevada Subalpine Lodgepole Pine Forest and Woodland	0.03	0.69

Title: D17 FIU Site Characterization: Supporting Data	Author: Luo/ Ayres/Loescher	Date: 09/26/2011
NEON Doc. #: NEON.DOC.011077		Revision: B

Total Area Sq Km	4.00	100.00
------------------	------	--------

The ecosystem at the immediate area around the tower and in the tower airshed is a natural regenerating stand, very diverse with a mix of red fir, ponderosa and Jeffers pine, white fir, etc. Age structure is also very diverse. Mean canopy height is ~ 35 m. Some individual trees are emergent with ~>50 m in height, and 2 other lower co-dominant canopies range from 25 – 37 m. The canopy is extremely rough and ~ 25-30% open with the understory being dominated by numerous cohorts of establishing different species. Regeneration is active. Understory mainly forms by young trees with 3 layers at 3 m, 7 m and 13 m. Vegetation on forest floor is short (~0.2 m) and sparse. There are few large stumps that were harvested decades ago. There is also a very large coarse wood debris pool, primarily old stems and new (small) branch falls. Risk of tree fall exists, but is low. It appears that this forest has frequent disturbance (branch falls, tree falls, frost kill, etc.). This forest appears to be high disturbance subject from cold. Only a small fraction of the actively accruing establishing tree/saplings get mature.

Table 15. Ecosystem and site attributes for the Lower Teakettle Relocatable site.

Ecosystem attributes	Measure and units
Mean canopy height ^a	35 m
Surface roughness ^a	5 m
Zero place displacement height ^a	27 m
Structural elements	Tall conifer forest, rough canopy with individual emergent trees
Time zone	Pacific time zone
Magnetic declination	13° 29' E changing by 0° 6' W/year

Note, ^a From field survey

Title: D17 FIU Site Characterization: Supporting Data	Author: Luo/ Ayres/Loescher	Date: 09/26/2011
NEON Doc. #: NEON.DOC.011077		Revision: B



Figure 45. Mixed conifer forest is the dominated ecosystem at Lower Teakettle Relocatable site.

5.3 Soils

5.3.1 Description of soils

Soil data and soil maps below for the Lower Teakettle tower site were collected from 3.3 km² NRCS soil maps (<http://websoilsurvey.nrcs.usda.gov/app/HomePage.htm>) to determine the dominant soil types in the larger tower foot print. This was done to assure that the soil array is in the dominant (or in the co-dominant) soil type present in the tower footprint.

Title: D17 FIU Site Characterization: Supporting Data	Author: Luo/ Ayres/Loescher	Date: 09/26/2011
NEON Doc. #: NEON.DOC.011077		Revision: B

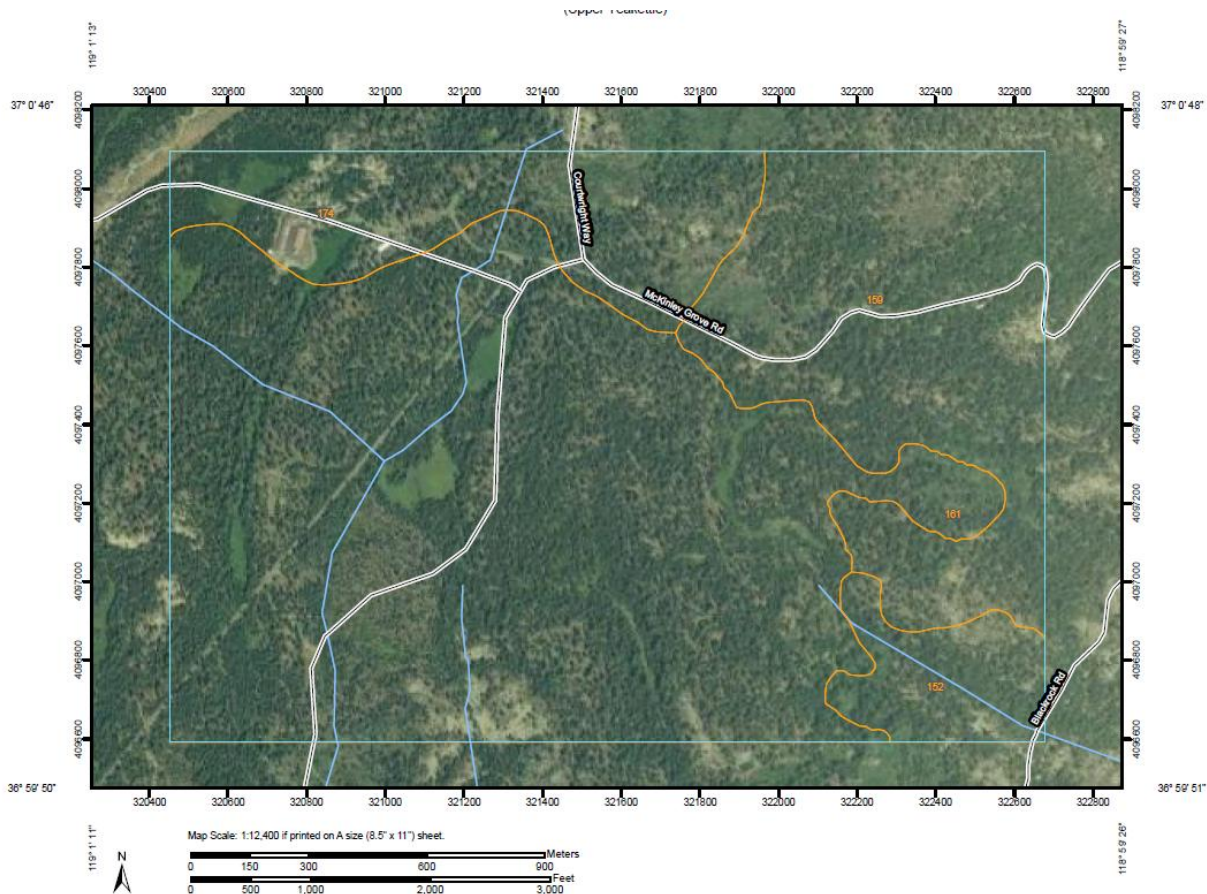

Figure 46. Soil map of the Lower Teakettle Relocatable site and surrounding areas.

Soil Map Units Description: The map units delineated on the detailed soil maps in a soil survey represents the soils or miscellaneous areas in the survey area. The map unit descriptions in this report, along with the maps, can be used to determine the composition and properties of a unit. A map unit delineation on a soil map represents an area dominated by one or more major kinds of soil or miscellaneous areas. A map unit is identified and named according to the taxonomic classification of the dominant soils. Within a taxonomic class there are precisely defined limits for the properties of the soils. On the landscape, however, the soils are natural phenomena, and they have the characteristic variability of all natural phenomena. Thus, the range of some observed properties may extend beyond the limits defined for a taxonomic class. Areas of soils of a single taxonomic class rarely, if ever, can be mapped without including areas of other taxonomic classes. Consequently, every map unit is made up of the soils or miscellaneous areas for which it is named and some minor components that belong to taxonomic classes other than those of the major soils. Most minor soils have properties similar to those of the dominant soil or soils in the map unit, and thus they do not affect use and management. These are called non-contrasting, or similar, components. They may or may not be mentioned in a particular map unit description. Other minor components, however, have properties and behavioral characteristics divergent enough to affect use or to require different management. These are called contrasting, or dissimilar, components. They generally are in small areas and could not be mapped separately because of the scale used. Some small areas of strongly contrasting soils or miscellaneous areas are identified by a special symbol on the maps. If included in the database for a given area, the contrasting minor

Title: D17 FIU Site Characterization: Supporting Data	Author: Luo/ Ayres/Loescher	Date: 09/26/2011
NEON Doc. #: NEON.DOC.011077		Revision: B

components are identified in the map unit descriptions along with some characteristics of each. A few areas of minor components may not have been observed, and consequently they are not mentioned in the descriptions, especially where the pattern was so complex that it was impractical to make enough observations to identify all the soils and miscellaneous areas on the landscape. The presence of minor components in a map unit in no way diminishes the usefulness or accuracy of the data. The objective of mapping is not to delineate pure taxonomic classes but rather to separate the landscape into landforms or landform segments that have similar use and management requirements. The delineation of such segments on the map provides sufficient information for the development of resource plans. If intensive use of small areas is planned, however, onsite investigation is needed to define and locate the soils and miscellaneous areas. An identifying symbol precedes the map unit name in the map unit descriptions. Each description includes general facts about the unit and gives important soil properties and qualities.

Soils that have profiles that are almost alike make up a *soil series*. All the soils of a series have major horizons that are similar in composition, thickness, and arrangement. Soils of a given series can differ in texture of the surface layer, slope, stoniness, salinity, degree of erosion, and other characteristics that affect their use. On the basis of such differences, a soil series is divided into *soil phases*. Most of the areas shown on the detailed soil maps are phases of soil series. The name of a soil phase commonly indicates a feature that affects use or management. For example, Alpha silt loam, 0 to 2 percent slopes, is a phase of the Alpha series. Some map units are made up of two or more major soils or miscellaneous areas. These map units are complexes, associations, or undifferentiated groups. A *complex* consists of two or more soils or miscellaneous areas in such an intricate pattern or in such small areas that they cannot be shown separately on the maps. The pattern and proportion of the soils or miscellaneous areas are somewhat similar in all areas. Alpha-Beta complex, 0 to 6 percent slopes, is an example. An *association* is made up of two or more geographically associated soils or miscellaneous areas that are shown as one unit on the maps. Because of present or anticipated uses of the map units in the survey area, it was not considered practical or necessary to map the soils or miscellaneous areas separately. The pattern and relative proportion of the soils or miscellaneous areas are somewhat similar. Alpha-Beta association, 0 to 2 percent slopes, is an example. An *undifferentiated group* is made up of two or more soils or miscellaneous areas that could be mapped individually but are mapped as one unit because similar interpretations can be made for use and management. The pattern and proportion of the soils or miscellaneous areas in a mapped area are not uniform. An area can be made up of only one of the major soils or miscellaneous areas, or it can be made up of all of them. Alpha and Beta soils, 0 to 2 percent slopes, are an example. Some surveys include *miscellaneous areas*. Such areas have little or no soil material and support little or no vegetation. Rock outcrop is an example. Additional information about the map units described in this report is available in other soil reports, which give properties of the soils and the limitations, capabilities, and potentials for many uses. Also, the narratives that accompany the soil reports define some of the properties included in the map unit descriptions.

Table 16. Soil series and percentage of soil series within 3.3 km² at the Lower Teakettle site

Title: D17 FIU Site Characterization: Supporting Data	Author: Luo/ Ayres/Loescher	Date: 09/26/2011
NEON Doc. #: NEON.DOC.011077		Revision: B

Sierra National Forest Area Parts of Fresno, California (CA750)			
Map Unit Symbol	Map Unit Name	Acres in AOI	Percent of AOI
152	ROCK OUTCROP-LITHIC XEROPSAMMENTS COMPLEX, 15 TO 45 PERCENT SLOPES	39.1	4.7%
159	SIRRETTA FAMILY-ROCK OUTCROP COMPLEX, 15 TO 45 PERCENT SLOPES	184.4	22.3%
161	SIRRETTA FAMILY AND UMPA FAMILY, WET, 2 TO 25 PERCENT SLOPES	498.1	60.3%
174	UMPA FAMILY, 5 TO 35 PERCENT SLOPES	104.6	12.7%
Totals for Area of Interest		826.3	100.0%

Sierra National Forest Area Parts of Fresno, California 152—ROCK OUTCROP-LITHIC XEROPSAMMENTS COMPLEX, 15 TO 45 PERCENT SLOPES Map Unit Setting Elevation: 6,200 to 8,400 feet Mean annual precipitation: 25 to 60 inches Mean annual air temperature: 39 to 50 degrees F Frost-free period: 75 to 100 days **Map Unit Composition** Rock outcrop: 60 percent Lithic xeropsamments and similar soils: 25 percent Minor components: 15 percent **Description of Rock Outcrop Setting** Landform: Mountains Landform position (two-dimensional): Backslope Landform position (three-dimensional): Mountainflank Down-slope shape: Concave Across-slope shape: Convex Interpretive groups Land capability (nonirrigated): 8 **Typical profile** 0 to 4 inches: Unweathered bedrock **Description of Lithic Xeropsamments Setting** Landform: Mountains Landform position (two-dimensional): Backslope Landform position (three-dimensional): Mountainflank Down-slope shape: Concave Across-slope shape: Concave Parent material: Residuum weathered from granodiorite **Properties and qualities** Slope: 15 to 45 percent Depth to restrictive feature: 11 to 15 inches to paralithic bedrock Drainage class: Excessively drained Capacity of the most limiting layer to transmit water (Ksat): Moderately low to very high (0.14 to 14.17 in/hr) Depth to water table: More than 80 inches Frequency of flooding: None Frequency of ponding: None Available water capacity: Very low (about 0.8 inches) Interpretive groups Land capability (nonirrigated): 7e **Typical profile** 0 to 11 inches: Loamy coarse sand 11 to 15 inches: Unweathered bedrock **Minor Components Stiretta family** Percent of map unit: 5 percent **Unnamed, steeper slopes** Percent of map unit: 5 percent **Unnamed, very gravelly** Percent of map unit: 5 percent

Sierra National Forest Area Parts of Fresno, California 161—SIRRETTA FAMILY AND UMPA FAMILY, WET, 2 TO 25 PERCENT SLOPES Map Unit Setting Elevation: 6,000 to 8,500 feet Mean annual precipitation: 25 to 55 inches Mean annual air temperature: 36 to 46 degrees F Frost-free period: 75 to 100 days **Map Unit Composition** Sirretta family and similar soils: 55 percent Umpa family, wet, wet, and similar soils: 30 percent Minor components: 15 percent **Description of Sirretta Family Setting** Landform: Moraines Landform position (two-dimensional): Backslope Landform position (three-dimensional): Mountainbase, riser Down-slope shape: Concave Across-slope shape: Concave Parent material: Till derived from granite **Properties and qualities** Slope: 3 to 25 percent Depth to restrictive feature: 60 to 64 inches to lithic bedrock Drainage class: Somewhat excessively drained Capacity of the most limiting layer to transmit water (Ksat): Moderately low to high (0.14 to 5.95 in/hr) Depth to water table: More than 80 inches Frequency of flooding: None Frequency of ponding: None Available water capacity: Low (about 3.2 inches) **Interpretive groups** Land capability (nonirrigated): 6e **Typical profile** 0 to 7 inches: Very gravelly coarse sandy loam 7 to 30 inches: Very cobbly loamy coarse sand 30 to 60 inches: Loamy coarse sand 60 to 64 inches: Unweathered bedrock **Description of Umpa Family, Wet, Wet Setting** Landform: Moraines Landform position (two-dimensional): Backslope Landform position (three-

Title: D17 FIU Site Characterization: Supporting Data	Author: Luo/ Ayres/Loescher	Date: 09/26/2011
NEON Doc. #: NEON.DOC.011077		Revision: B

dimensional): Riser Down-slope shape: Concave Across-slope shape: Concave Parent material: Till derived from granite **Properties and qualities** Slope: 3 to 10 percent Surface area covered with cobbles, stones or boulders: 1.0 percent Depth to restrictive feature: More than 80 inches Drainage class: Moderately well drained Capacity of the most limiting layer to transmit water (Ksat): High (1.98 to 5.95 in/hr) Depth to water table: About 20 inches Frequency of flooding: None Frequency of ponding: None Available water capacity: Low (about 4.3 inches) **Interpretive groups** Land capability (nonirrigated): 6e **Typical profile** 0 to 6 inches: Very stony coarse sandy loam 6 to 24 inches: Stony coarse sandy loam 24 to 60 inches: Very stony coarse sandy loam **Minor Components Unnamed, very gravelly** Percent of map unit: 5 percent **Unnamed, dark surface** Percent of map unit: 5 percent **Cagwin family** Percent of map unit: 5 percent

Sierra National Forest Area Parts of Fresno, California 159—SIRRETTA FAMILY-ROCK OUTCROP COMPLEX, 15 TO 45 PERCENT SLOPES Map Unit Setting Elevation: 6,000 to 8,500 feet Mean annual precipitation: 25 to 55 inches Mean annual air temperature: 36 to 46 degrees F Frost-free period: 75 to 100 days **Map Unit Composition** Sirretta family and similar soils: 60 percent Rock outcrop: 25 percent Minor components: 15 percent **Description of Sirretta Family Setting** Landform: Moraines Landform position (two-dimensional): Backslope Landform position (three-dimensional): Mountainflank Down-slope shape: Concave Across-slope shape: Convex Parent material: Till derived from granite **Properties and qualities** Slope: 15 to 45 percent Depth to restrictive feature: 60 to 64 inches to lithic bedrock Drainage class: Somewhat excessively drained Capacity of the most limiting layer to transmit water (Ksat): Moderately low to high (0.14 to 5.95 in/hr) Depth to water table: More than 80 inches Frequency of flooding: None Frequency of ponding: None Available water capacity: Low (about 3.2 inches) **Interpretive groups** Land capability (nonirrigated): 6e **Typical profile** 0 to 7 inches: Very gravelly coarse sandy loam 7 to 30 inches: Very cobbly loamy coarse sand 30 to 60 inches: Loamy coarse sand 60 to 64 inches: Unweathered bedrock **Description of Rock Outcrop Setting** Landform: Mountains Landform position (two-dimensional): Backslope Landform position (three-dimensional): Mountainflank Down-slope shape: Concave Across-slope shape: Convex **Interpretive groups** Land capability (nonirrigated): 8 **Typical profile** 0 to 4 inches: Unweathered bedrock **Minor Components Unnamed, colluvium** Percent of map unit: 5 percent **Gerle family** Percent of map unit: 5 percent **Cagwin family** Percent of map unit: 5 percent

Sierra National Forest Area Parts of Fresno, California 174—UMPA FAMILY, 5 TO 35 PERCENT SLOPES Map Unit Setting Elevation: 6,000 to 7,600 feet Mean annual precipitation: 30 to 50 inches Mean annual air temperature: 36 to 46 degrees F Frost-free period: 75 to 100 days **Map Unit Composition** Umpa family and similar soils: 80 percent Minor components: 20 percent **Description of Umpa Family Setting** Landform: Moraines Landform position (two-dimensional): Footslope Landform position (three-dimensional): Mountainflank, mountainbase Down-slope shape: Concave Across-slope shape: Convex Parent material: Till derived from granite **Properties and qualities** Slope: 5 to 35 percent Surface area covered with cobbles, stones or boulders: 0.1 percent Depth to restrictive feature: 20 to 40 inches to paralithic bedrock Drainage class: Well drained Capacity of the most limiting layer to transmit water (Ksat): High (1.98 to 5.95 in/hr) Depth to water table: More than 80 inches Frequency of flooding: None Frequency of ponding: None Available water capacity: Very low (about 2.2 inches) **Interpretive groups** Land capability (nonirrigated): 6e **Typical profile** 0 to 6 inches: Very bouldery sandy loam 6 to 48 inches: Sandy loam 48 to 60 inches: Very stony coarse sandy loam **Minor Components Sirretta family** Percent of map unit: 10 percent **Gerle family** Percent of map unit: 10 percent

Title: D17 FIU Site Characterization: Supporting Data	Author: Luo/ Ayres/Loescher	Date: 09/26/2011
NEON Doc. #: NEON.DOC.011077		Revision: B

5.3.2 Soil semi-variogram description

The goal of this aspect of the site characterization is to determine the minimum distance between the soil plots in the soil array such that data farther apart can be considered spatially independent. The collected field data will be used to produce semivariograms, which is a geostatistical technique to characterize spatial autocorrelation between mapped samples of a quantitative variable (*e.g.*, soil property data in our case). In an empirical semivariogram, the average of the squared differences of a response variable is computed for all pairs of points within specified distance intervals (lag classes). The output is presented graphically as a plot of the average semi-variance versus distance class (Figure 47). For the theoretical variogram models considered here, the semivariance will converge on the total variance at distances for which values are no longer spatially auto-correlated (this is referred to as the range, Figure 47).

For the theoretical variograms considered here, three parameters estimated from the data are used to fit a semivariogram model to the empirical semivariogram. This model is then assumed to quantitatively represent the correlation as a function of distance (Figure 47), the range, the sill (the sill is the asymptotic value of semi-variance at the range), and the nugget (which describes sampling error or variation at distances below those separating the closest pairs of samples). The range, sill and nugget are estimated from theoretical models that are fitted to the empirical variograms using non-linear least squares methods.

The variogram analysis will be used, to determine the spatial scales at which we can consider soil measurements spatially independent. This characterization will directly inform the minimum distance between *i)* soil plots within each soil array, *ii)* the soil profile measurements, *iii)* EP plots, and *iv)* the microbial sampling locations. These data will directly inform NEON construction and site design activities.

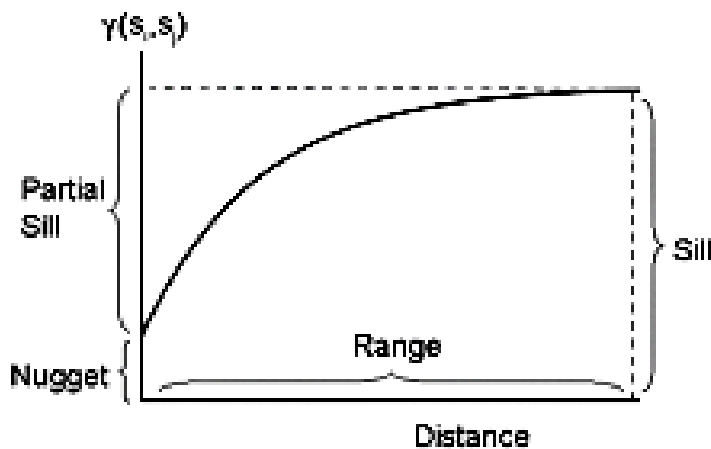

Figure 47. Example semivariogram, depicting range, sill, and nugget.

Title: D17 FIU Site Characterization: Supporting Data	Author: Luo/ Ayres/Loescher	Date: 09/26/2011
NEON Doc. #: NEON.DOC.011077		Revision: B

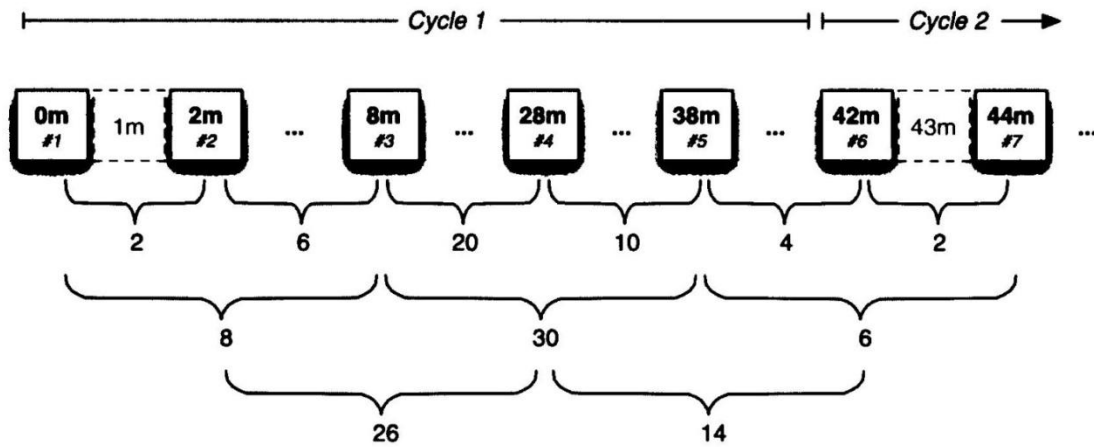

Figure 48. Spatially cyclic sampling design for the measurements of soil temperature and soil water content.

Field measurements of soil temperature (0-12 cm) and moisture (0-15 cm) were taken on 15 July 2010 at the Lower Teakettle site. The sampling points followed the spatially cyclic sampling design by Bond-Lamberty et al. (2006) (Figure 48). Soil temperature and moisture measurements were collected along three transects (168 m, 84 m, and 84 m) located in the expected airshed at Lower Teakettle. Details of how the airshed was determined are provided below. Soil temperature was measured with platinum resistance temperature sensors (RTD 810, Omega Engineering Inc., Stamford CT) and soil moisture was measured with time domain dielectric sensors (CS616, Campbell Scientific Inc., Logan UT).

As well as measuring soil temperature and moisture at each sample point in Figure 48, measurements were also taken 30 cm in front and behind the sampling point along the axis of the transect. For example, at the 2 m sampling point, soil temperature and moisture was measured at 1.7 m, 2 m, and 2.3 m; this data is referred to as mobile data, since the measurements were taken at many different locations. In addition, soil temperature and moisture were continuously recorded at a single fixed location (stationary data) throughout the sampling time to correct for changes in temperature and moisture throughout the day.

Data collected were used for geospatial analyses of variograms in the R statistical computing language with the geoR package to test for spatial autocorrelation (Trangmar *et al.* 1986; Webster & Oliver 1989; Goovaerts 1997; Riberiro & Diggle 2001) and estimate the distance necessary for independence among soil plots in the soil array. To correct for changes in temperature and moisture over the sampling period, the stationary data was subtracted from the mobile data. In many instances a time of day trend was still apparent in the data even after subtracting the stationary data from the mobile data. This time of day trend was corrected for by fitting a linear regression and using the residuals for the semivariogram analysis. Soil temperature and moisture data, R code, graphs, and R output can be found at: P:\FIU\FIU_Site_Characterization\DXX\YYYYYYY_Characterization\Soil Measurements\Soil Data Analysis (where XX = domain number and YYYYYYY = site name).

<i>Title:</i> D17 FIU Site Characterization: Supporting Data	<i>Author:</i> Luo/ Ayres/Loescher	<i>Date:</i> 09/26/2011
<i>NEON Doc. #:</i> NEON.DOC.011077		<i>Revision:</i> B

5.3.3 Results and interpretation

5.3.3.1 Soil Temperature

Soil temperature data residuals, after accounting for changes in temperature in the stationary data, any remaining time of day trend, and slope and aspect trends, were used for the semivariogram analysis (Figure 49). Exploratory data analysis plots show that there was no distinct patterning of the residuals (Figure 50, left graph) and directional semivariograms do not show anisotropy (Figure 50, center graph). An isotropic empirical semivariogram was produced and a spherical model was fitted using Cressie weights (Figure 50, right graph). The model indicates a distance of effective independence of 11 m for soil temperature.

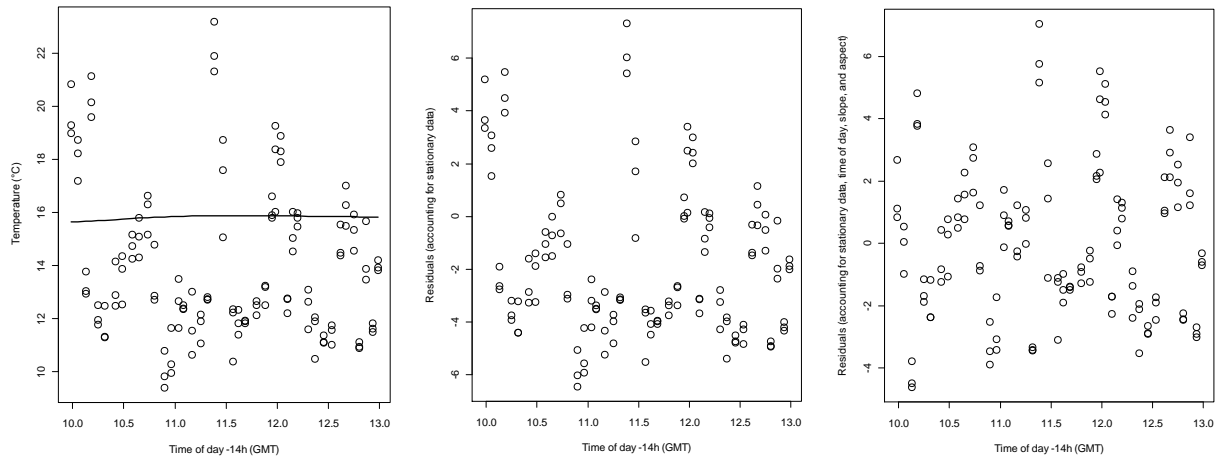

Figure 49. Left graph: mobile (circles) and stationary (line) soil temperature data. Center graph: temperature data after correcting for changes in temperature in the stationary data (circles) and a linear regression based on time of day (line). Right graph: residual temperature data after correcting for changes temperature in the stationary data and the time of day regression. Data in the right graph were used for the semivariogram analysis.

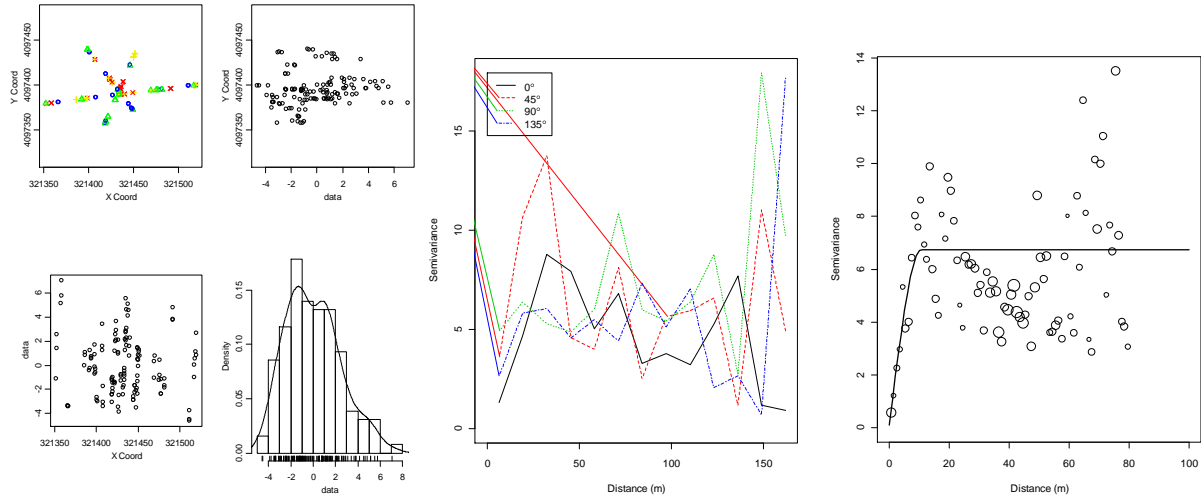

Figure 50. Left graphs: exploratory data analysis plots for residuals of temperature. Center graph: directional semivariograms for residuals of temperature. Right graph: empirical semivariogram (circles) and model (line) fit to residuals of temperature.

5.3.3.2 Soil water content

Soil water content data residuals, after accounting for changes in water content in the stationary data, any remaining time of day trend, and elevation, slope and aspect trends, were used for the semivariogram analysis (Figure 51). Exploratory data analysis plots show that there was little distinct patterning of the residuals (Figure 52, left graph) and directional semivariograms do not show anisotropy (Figure 52, center graph). An isotropic empirical semivariogram was produced and a spherical model was fitted using Cressie weights (Figure 52, right graph). The model indicates a distance of effective independence of 13 m for soil water content.

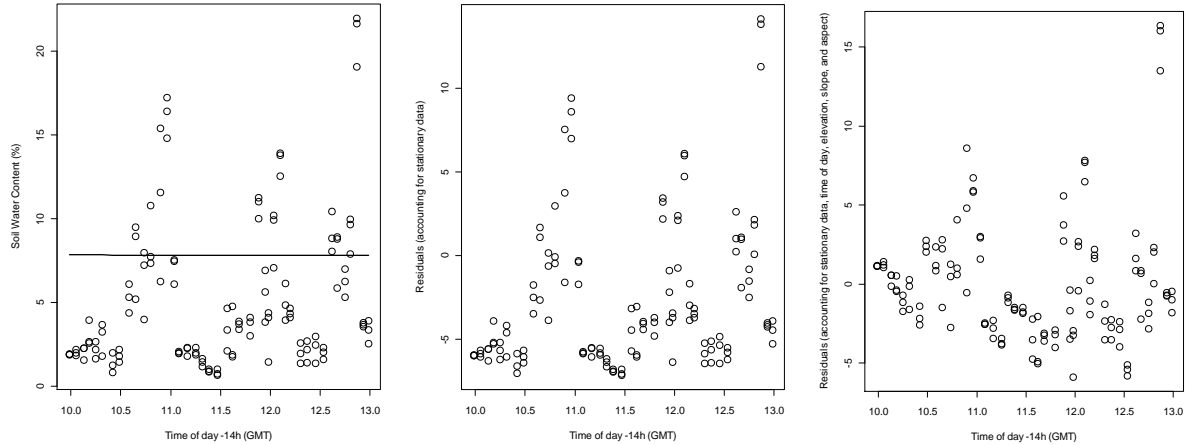

Figure 51. Left graph: mobile (circles) and stationary (line) soil water content data. Center graph: water content data after correcting for changes in water content in the stationary data (circles) and a linear regression based on time of day (line). Right graph: residual water content data after correcting for

Title: D17 FIU Site Characterization: Supporting Data	Author: Luo/ Ayres/Loescher	Date: 09/26/2011
NEON Doc. #: NEON.DOC.011077		Revision: B

changes water content in the stationary data and the time of day regression. Data in the right graph were used for the semivariogram analysis.

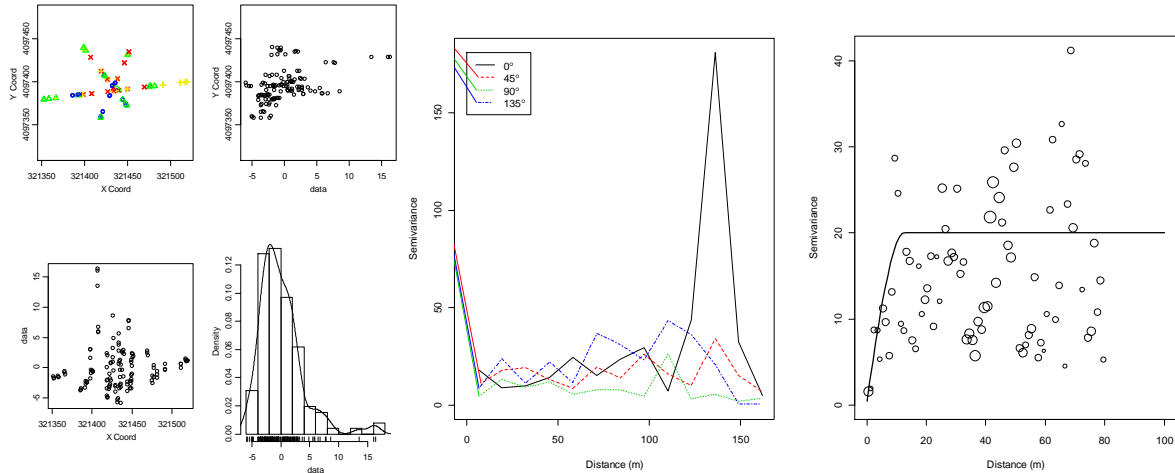

Figure 52. Left graphs: exploratory data analysis plots for residuals of soil water content. Center graph: directional semivariograms for residuals of water content. Right graph: empirical semivariogram (circles) and model (line) fit to residuals of water content.

5.3.3.3 Soil array layout and soil pit location

The minimum distance allowable between soil plots is 25 m to ensure a degree of spatial independence in non-measured soil parameters (i.e., other than temperature and water content) and the maximum distance allowable between soil plots is 40 m due to cost constraints. The estimated distance of effective independence was 11 m for soil temperature and 13 m for soil moisture. Based on these results and the site design guidelines the soil plots at Lower Teakettle shall be placed 25 m apart. The soil array shall follow the linear soil array design (Soil Array Pattern B) with the soil plots being 5 m x 5 m. The direction of the soil array shall be 200° from the soil plot nearest the tower (i.e., first soil plot). The location of the first soil plot will be approximately 37.005662, -119.006098. The exact location of each soil plot may be microsited to avoid placing a soil plot at an unrepresentative location (e.g., rock outcrop, drainage channel, large tree, etc). The FIU soil pit for characterizing soil horizon depths, collecting soil for site-specific sensor calibration, and collecting soil for the FIU soil archive will be located at 37.005670°, -119.002861° (primary location); or 37.005338°, -119.002987° (alternate location 1 if primary location is unsuitable); or 37.004942°, -119.002981° (alternate location 2 if primary location is unsuitable). A summary of the soil information is shown in Table 17 and site layout can be seen in Figure 53.

Dominant soil series at the site: Sirretta family and Umpa family, wet, 2 to 25 percent slopes. The taxonomy of this soil is shown below:

Order: Entisols- Inceptisols

Suborder: Orthents- Xerepts

Great group: Xerorthents- Dystroxerepts

Subgroup: Dystric Xerorthents- Andic Dystroxerepts

Title: D17 FIU Site Characterization: Supporting Data	Author: Luo/ Ayres/Loescher	Date: 09/26/2011
NEON Doc. #: NEON.DOC.011077		Revision: B

Family: Sandy-skeletal, mixed, frigid Dystric Xerorthents-Loamy-skeletal, isotic, frigid Andic Dystrochrepts

Series: Sirretta family and Umpa family, wet , 2 to 25 percent slopes

Table 17. Summary of soil array and soil pit information at Lower Teakettle. 0° represents true north and accounts for declination.

Soil plot dimensions	5 m x 5 m
Soil array pattern	B
Distance between soil plots: x	25 m
Distance from tower to closest soil plot: y	20 m
Latitude and longitude of 1 st soil plot OR direction from tower	37.005662, -119.006098
Direction of soil array	200°
Latitude and longitude of FIU soil pit 1	37.005670°, -119.002861° (primary location)
Latitude and longitude of FIU soil pit 2	37.005338°, -119.002987° (alternate 1)
Latitude and longitude of FIU soil pit 3	37.004942°, -119.002981° (alternate 2)
Dominant soil type	Sirretta family and Umpa family, wet , 2 to 25 percent slopes
Expected soil depth	1.52 to >2 m
Depth to water table	>2 m

Expected depth of soil horizons	Expected measurement depths*
0-0.18 m (Very gravelly coarse sandy loam)	0.09 m [†]
0.18-0.76 m (Very cobbly loamy coarse sand)	0.47 m [†]
0.76-1.52 m (Loamy coarse sand)	1.14 m [†]
1.52-1.63 m (Unweathered bedrock)	1.58 m
2.00 m	2.00 m

*Actual soil measurement depths will be determined based on measured soil horizon depths at the NEON FIU soil pit and may differ substantially from those shown here.

[†]Expected soil CO₂ sensor depths

Title: D17 FIU Site Characterization: Supporting Data	Author: Luo/ Ayres/Loescher	Date: 09/26/2011
NEON Doc. #: NEON.DOC.011077		Revision: B

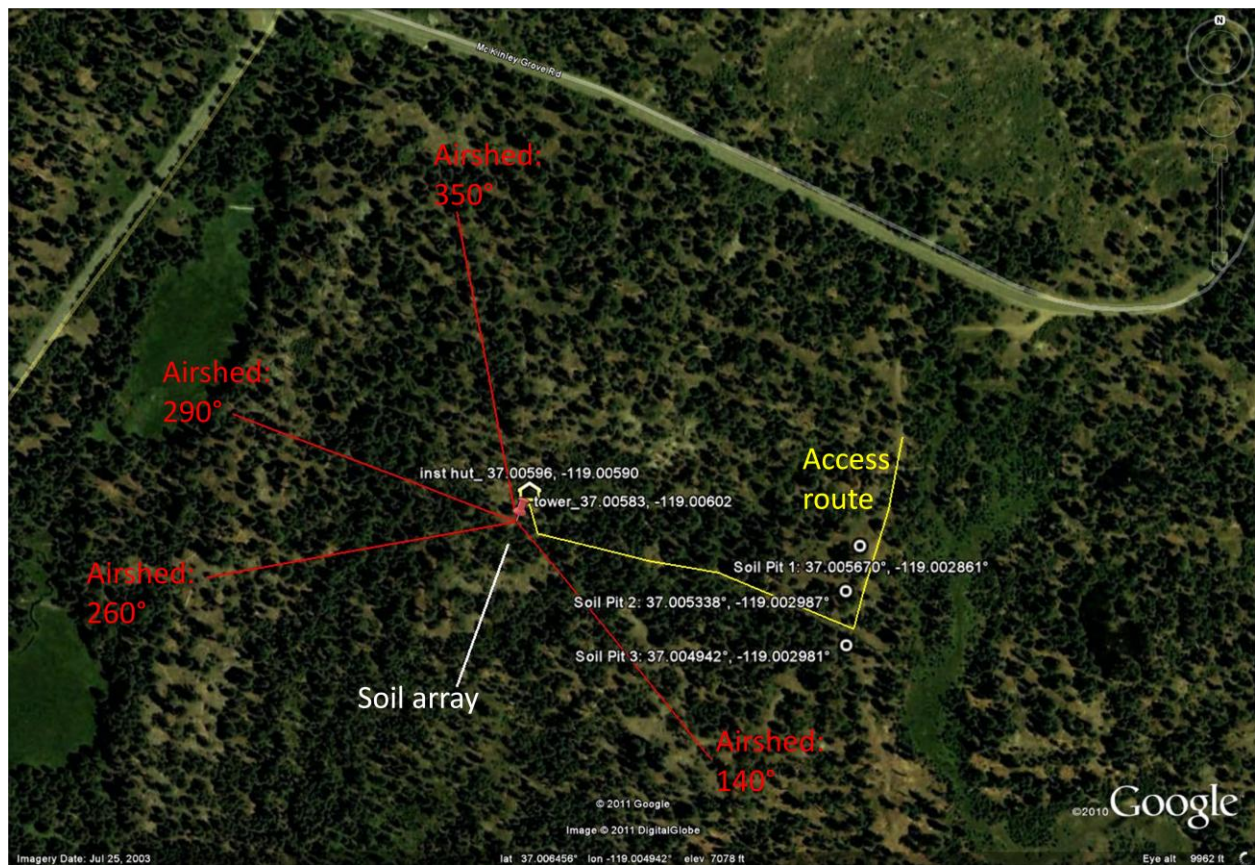

Figure 53. Site layout at Lower Teakettle showing soil array and location of the FIU soil pit.

5.4 Airshed

5.4.1 Seasonal windroses

Wind roses analytically determine and graphically represent the frequencies of wind direction and wind speed over a given timeseries. The weather data used to generate the following wind roses are 2007-2009 data from MesoWest weather station DINKEY station (ID: DKYC1, Lat: 37.0664, Long: -119.0394), which is 4.5 miles away from Lower Teakettle Relocatable site. This is the closest weather station that has available wind data we can use. Due to the complex mountain topography and terrain, it is possible that the wind patterns at NEON site are actually different with the pattern presented below. Wind patterns need to be reassessed with > 1 year on site wind data after construction. The orientation of the wind rose follows that of a compass (assume declination applied). When we describe the wind directions it should be noted that they are the cardinal direction that wind blows from. The directions of the rose with the longest spoke show wind directions with the largest frequency. These wind roses are subdivided into as 24 cardinal directions.

5.4.2 Results (graphs for wind roses)

Title: D17 FIU Site Characterization: Supporting Data	Author: Luo/ Ayres/Loescher	Date: 09/26/2011
NEON Doc. #: NEON.DOC.011077		Revision: B

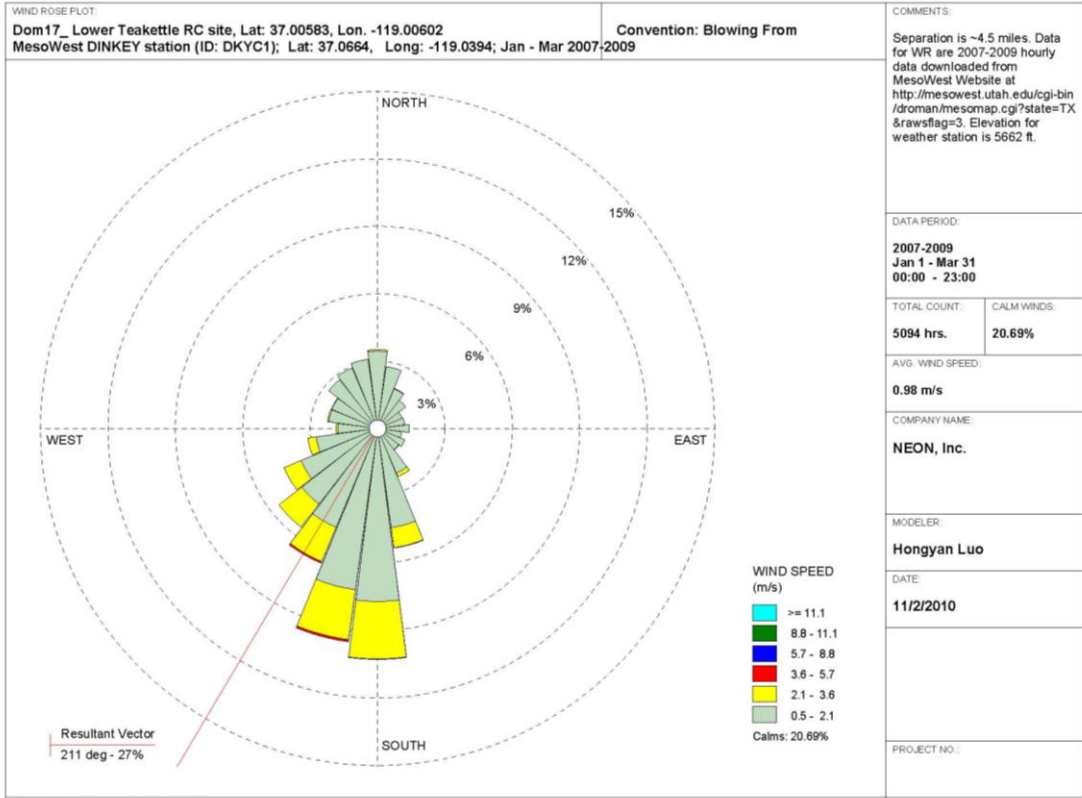

WRPLOT View - Lakes Environmental Software

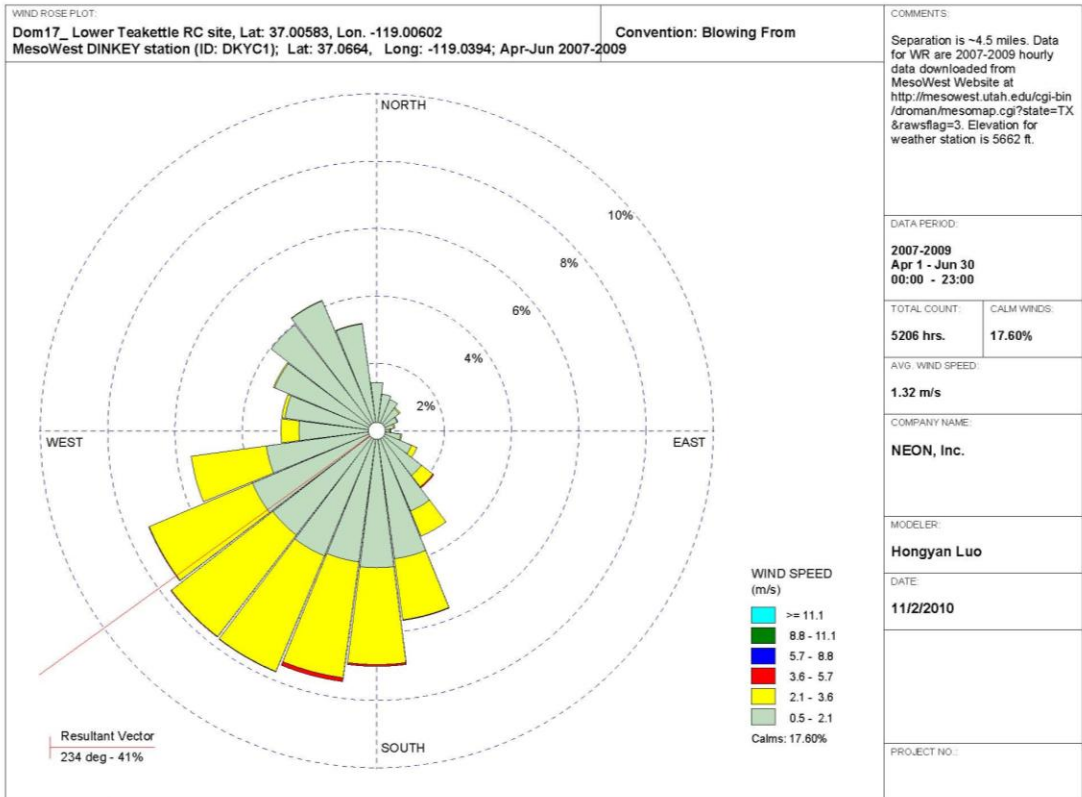

WRPLOT View - Lakes Environmental Software

Title: D17 FIU Site Characterization: Supporting Data	Author: Luo/ Ayres/Loescher	Date: 09/26/2011
NEON Doc. #: NEON.DOC.011077		Revision: B

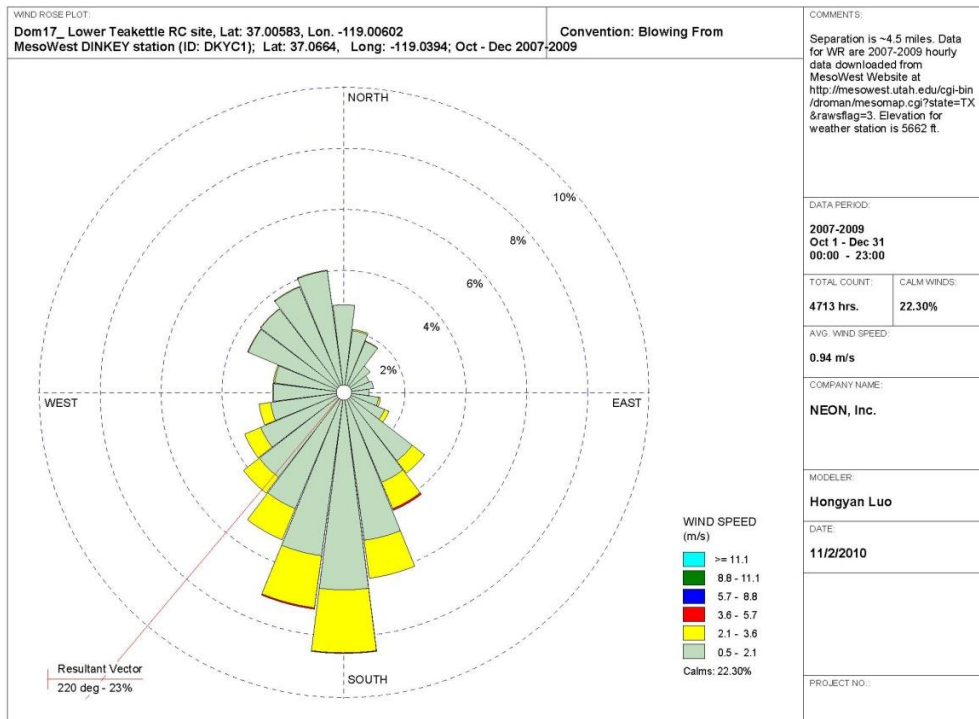
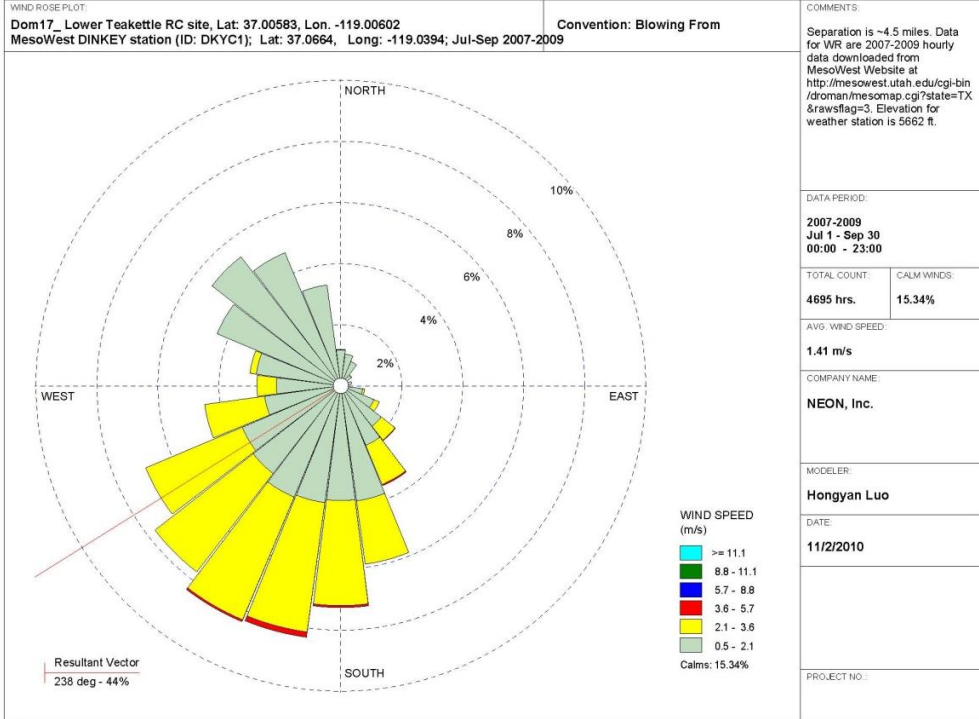

Figure 54. Windroses for Lower Teakettle relocatable site. The weather data used to generate the following wind roses are 2007-2009 data from MesoWest weather station DINKEY station (ID: DKYC1, Lat: 37.0664, Long: -119.0394), which is 4.5 miles away from Lower Teakettle Relocatable site. Panels are (from top to bottom) Jan-Mar, Apr-Jun, Jul-Sept, and Oct-Dec.

Title: D17 FIU Site Characterization: Supporting Data	Author: Luo/ Ayres/Loescher	Date: 09/26/2011
NEON Doc. #: NEON.DOC.011077		Revision: B

5.4.3 Resultant vectors

Table 18. The resultant wind vectors for Lower Teakettle Relocatable site using hourly data in 2007-2009.

Quarterly (seasonal) timeperiod	Resultant vector(°)	% duration
January to March	211	27
April to June	234	41
July to September	238	44
October to December	220	23
Annual mean	225.75°	na.

5.4.4 Expected environmental controls on source area

Two types of models were commonly used to determine the shape and extent of the source area under different and contrasting atmospheric stability classes. An inverted plume dispersion model with modeled cross wind solutions were used for convective conditions (Horst and Weil 1994). For strongly stable conditions, and Lagrangian solution was used (Kormann and Meixner 2001). The source area models were bounded by the expected conditions depict the extreme conditions. Convective conditions typically have strong vertical mixing between the ecosystem and atmosphere (surface layer). Stable conditions typically have long source area and associated waveforms. Convective turbulence is often characterized by short mixing scales (scalar) and moderate daytime wind speeds, *e.g.*, 1-4 m s⁻². Higher wind speeds, like those experienced over the Rockies, are often the product of mechanical turbulence with long waveforms. Because thermal stratification is very efficient in suppressing vertical mixing, stable conditions also have typically very long waveforms.

As a general rule, shorter and less structurally complex ecosystems have good vertical mixing during all atmospheric stabilities. Taller and more structurally complex ecosystems have well mixed upper canopies during the daytime, and can be decoupled below the canopy under neutral and stable conditions (*e.g.*, Harvard Forest, Bartlett Experimental Forest, and Burlington Conservation Area). The type of turbulence (mechanical versus convective) and the physical attributes of the ecosystem control the degree of mixing, and the length and size of the source area.

Here, we use a web-based footprint model to determine the footprint area under various conditions (model info: <http://www.geos.ed.ac.uk/abs/research/micromet/EdiTools/>). Winds used to run the model and generate following model results are extracted from the wind roses. Vegetation information, temperature and energy information were either from the RFI document, previous site visit report, available data files or best estimated from experienced expert. Measurement height was determined from the Tower Height requirements (NEON.FI.3.302, NEON.FI.3.303) and reported in Info document provided by ENG group, then verify according to the real ecosystem structure after FIU site characterization at site. Runs 1-3 and 4-6 represent the expected conditions for summer and winter conditions, respectively, with maximum and mean windspeeds (daytime convective) and nighttime (stable atmospheres) conditions. The wind vector for each run was estimated from wind roses and is placed as a centerline in the site map included in the graphics. The width of the footprint was also estimated using the length between the isopleth of 80% cumulative flux and center line to calculate the

Title: D17 FIU Site Characterization: Supporting Data	Author: Luo/ Ayres/Loescher	Date: 09/26/2011
NEON Doc. #: NEON.DOC.011077		Revision: B

angle from centerline. This information, along with distance of the cumulative flux isopleths and wind direction, will define the source area for the flux measurements on the top of the tower.

Table 19. Expected environmental controls to parameterize the source area model and associated results for Lower Teakettle Relocatable tower site.

Parameters	Run 1	Run 2	Run 3	Run 4	Run 5	Run 6	
Approximate season	summer			winter			Units
	Day (max WS)	Day (mean WS)	Night	Day (max WS)	Day (mean WS)	night	qualitative
Atmospheric stability	Convective	convective	Stable	Convective	convective	Stable	qualitative
Measurement height	53	53	53	53	53	53	m
Canopy Height	35	35	35	35	35	35	m
Canopy area density	3.5	3.5	3.5	3	3	3	m
Boundary layer depth	3500	3500	1800	1500	1500	1000	m
Expected sensible heat flux	650	650	175	300	300	50	W m ⁻²
Air Temperature	34	34	22	22	22	17	°C
Max. windspeed	5.6	2.6	1.6	5.6	2.6	1.6	m s ⁻¹
Resultant wind vector	210	210	315	195	195	340	degrees
Results							
(z-d)/L	-0.19	-0.33	-0.33	-0.11	-0.37	-0.35	m
d	28	28	28	28	28	28	m
Sigma v	3	2.8	1.6	2.3	1.8	0.94	m ² s ⁻²
Z0	1.5	1.5	1.5	1.5	1.5	1.5	m
u*	0.97	0.81	0.53	0.91	0.61	0.34	m s ⁻¹
Distance source area begins	0	0	0	0	0	0	m
Distance of 90% cumulative flux	750	250	250	980	400	480	m
Distance of 80% cumulative flux	450	200	200	500	250	300	m
Distance of 70% cumulative flux	350	150	150	400	200	200	m
Peak contribution	85	25	25	105	45	55	m

5.4.5 Results (source area graphs)

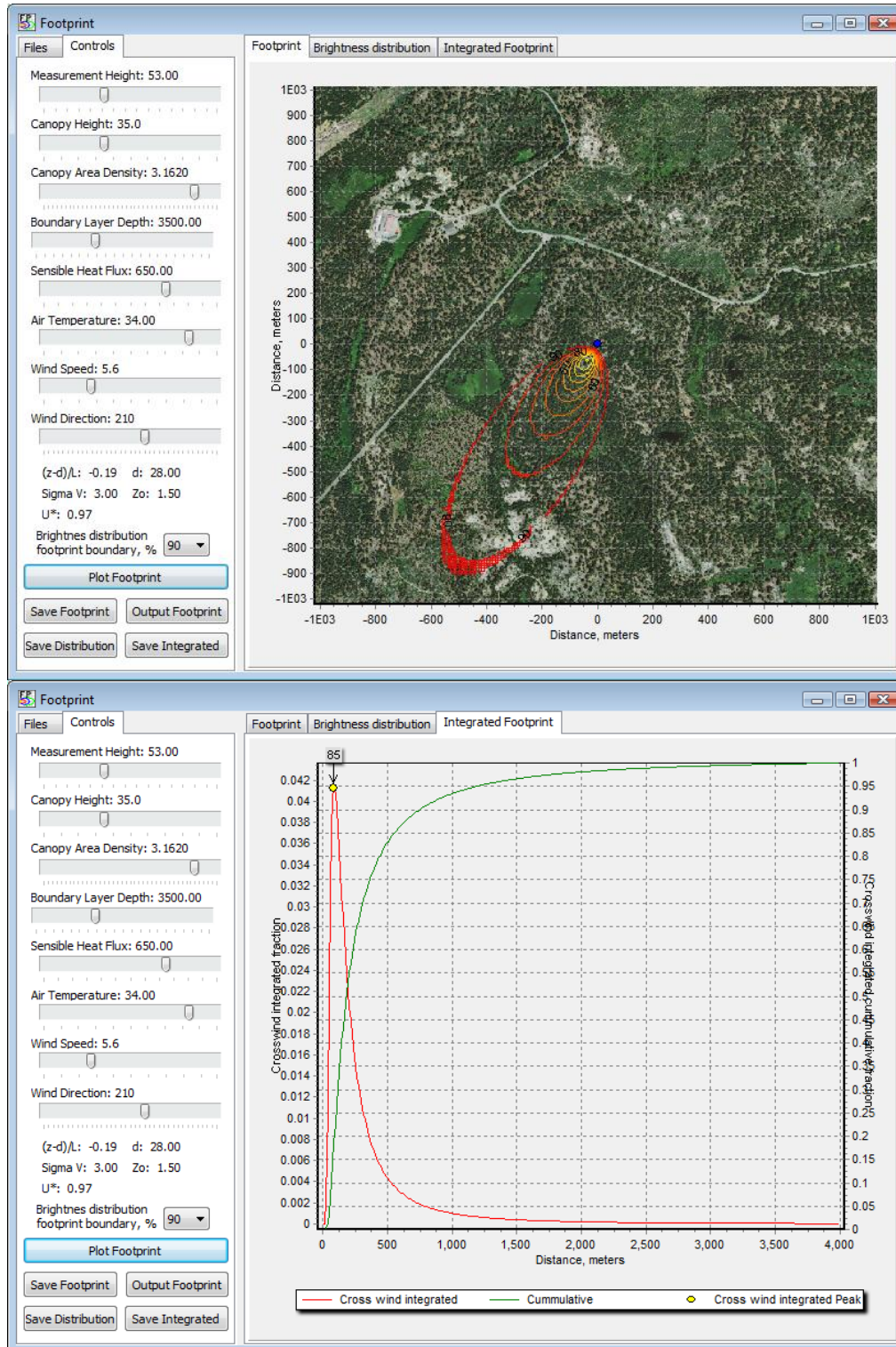

Figure 55. Lower Teakettle Relocatable site summer daytime (convective) footprint output with max wind speed

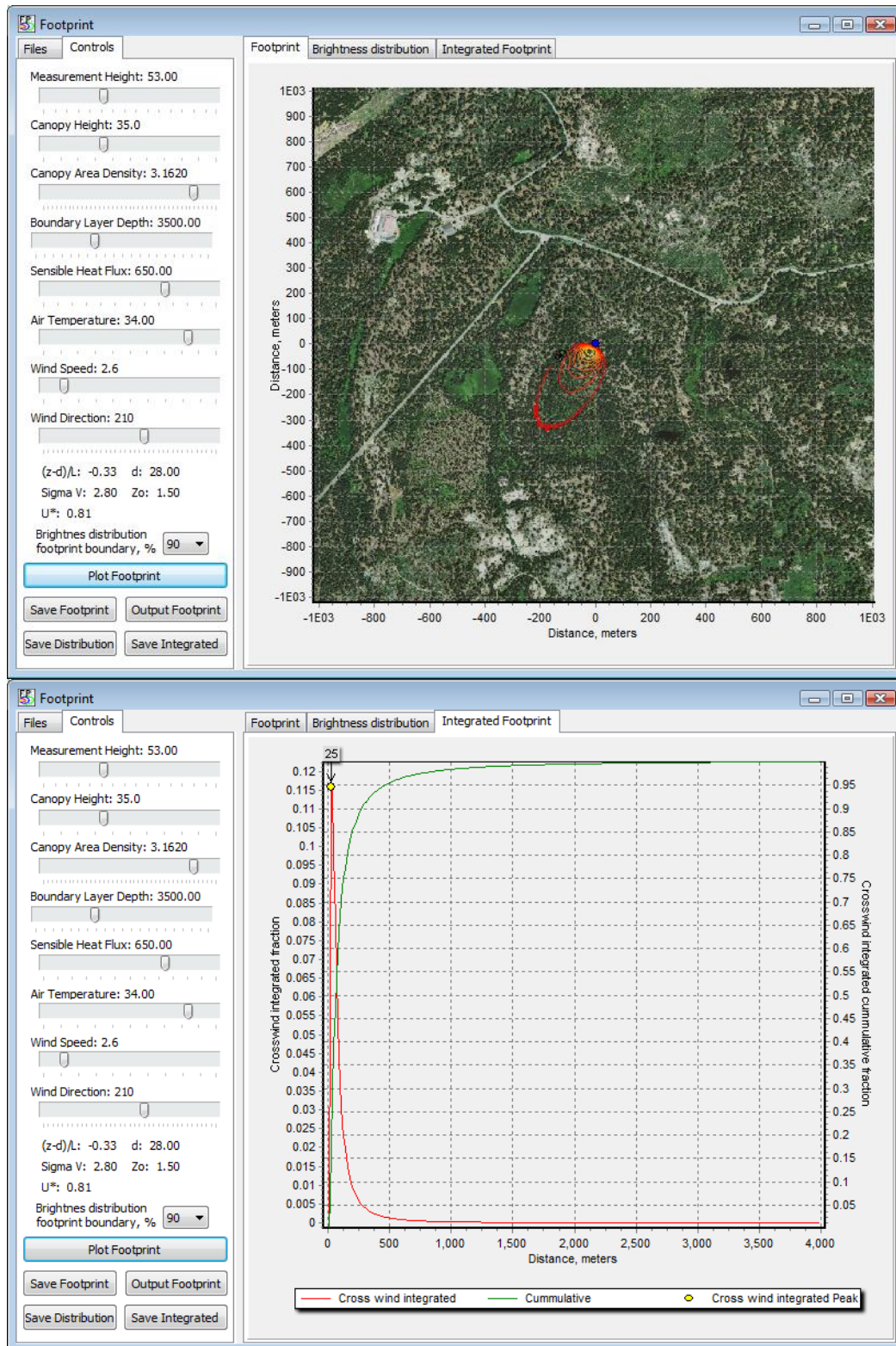

Figure 56. Lower Teakettle Relocatable site summer daytime (convective) footprint output with mean wind speed

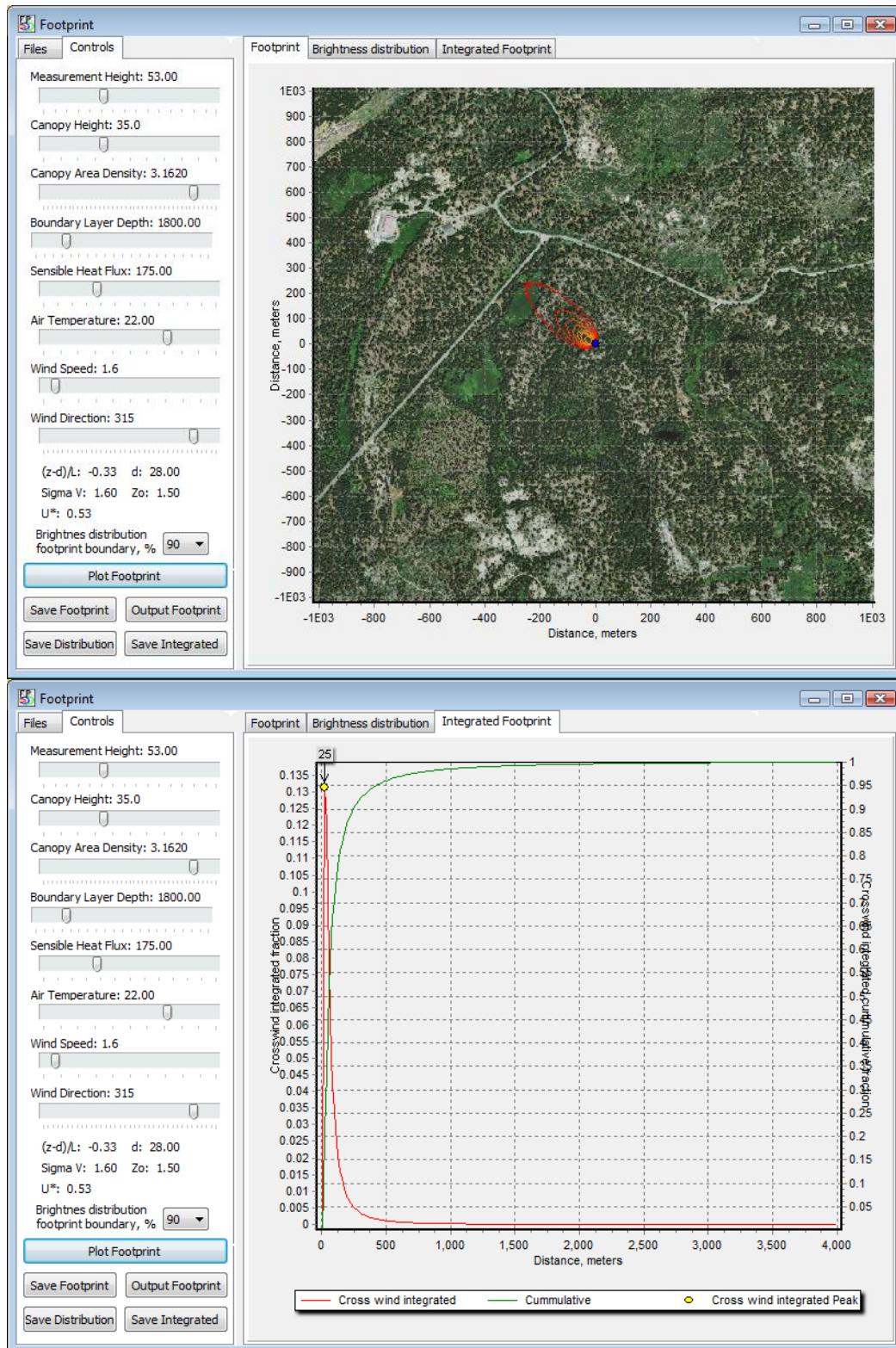

Figure 57. Lower Teakettle Relocatable site summer nighttime (stable) footprint output with mean wind speed

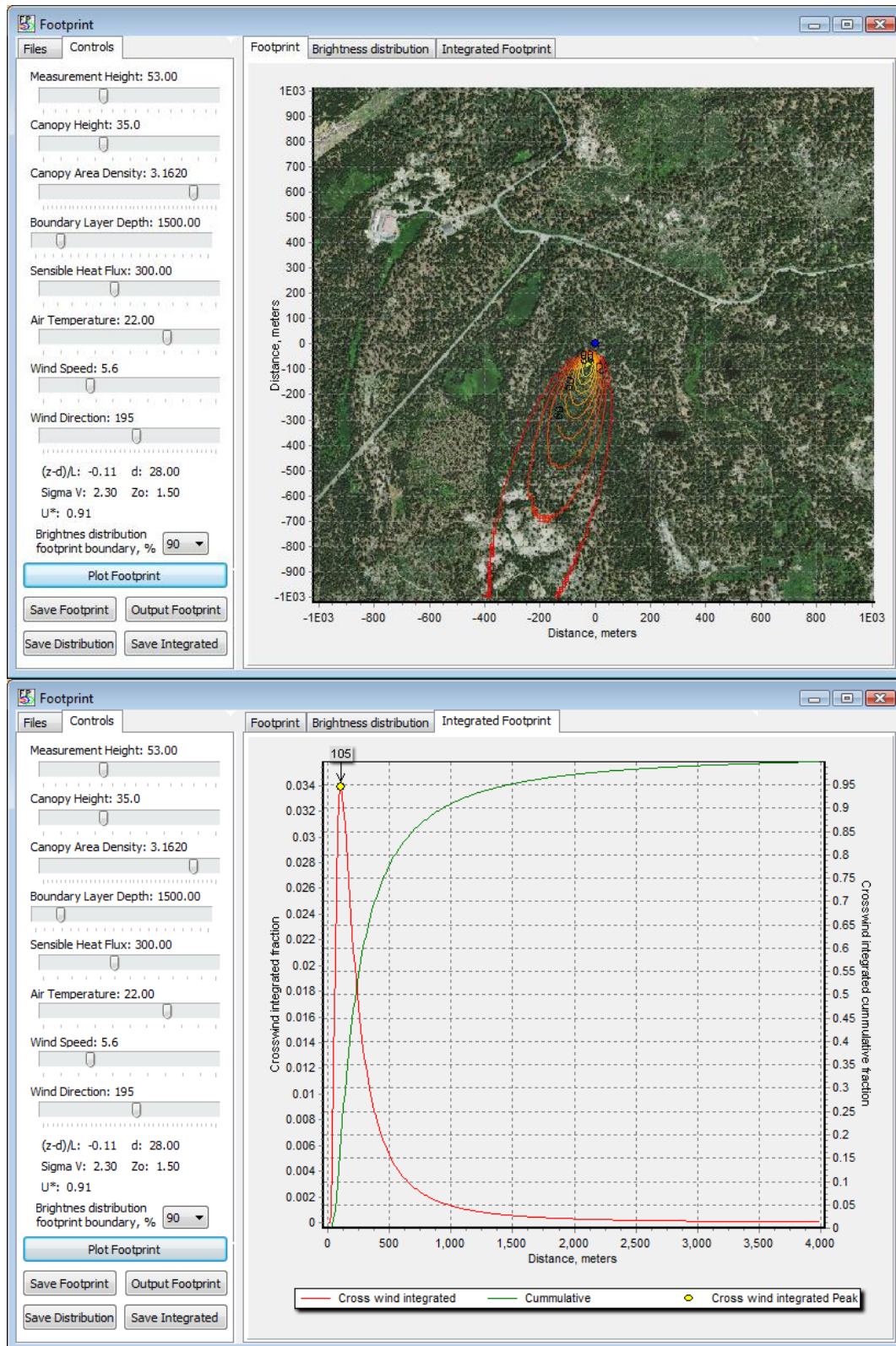

Figure 58. Lower Teakettle Relocatable site winter daytime (convective) footprint output with max wind speed

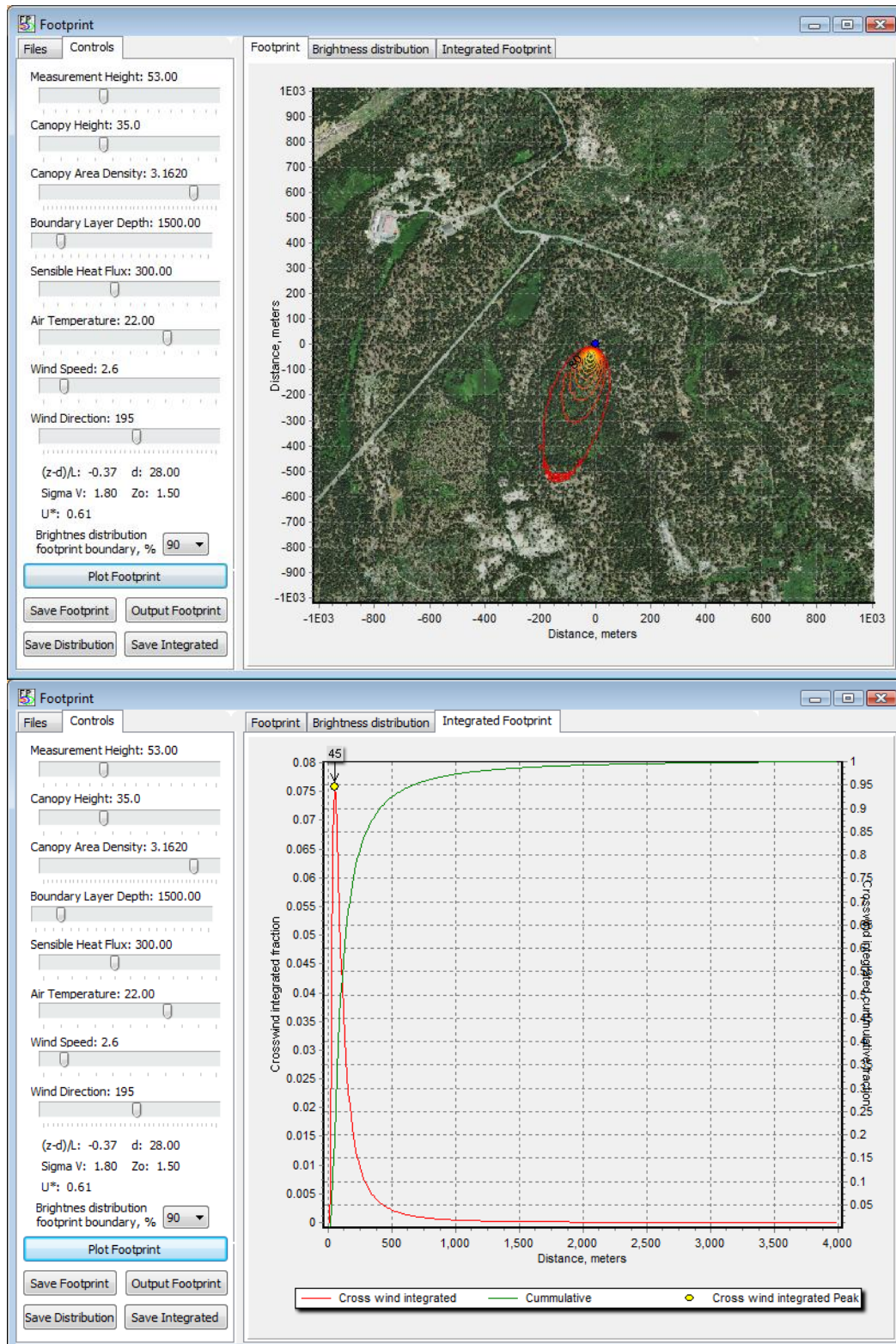

Figure 59. Lower Teakettle Relocatable site winter daytime (convective) footprint output with mean wind speed

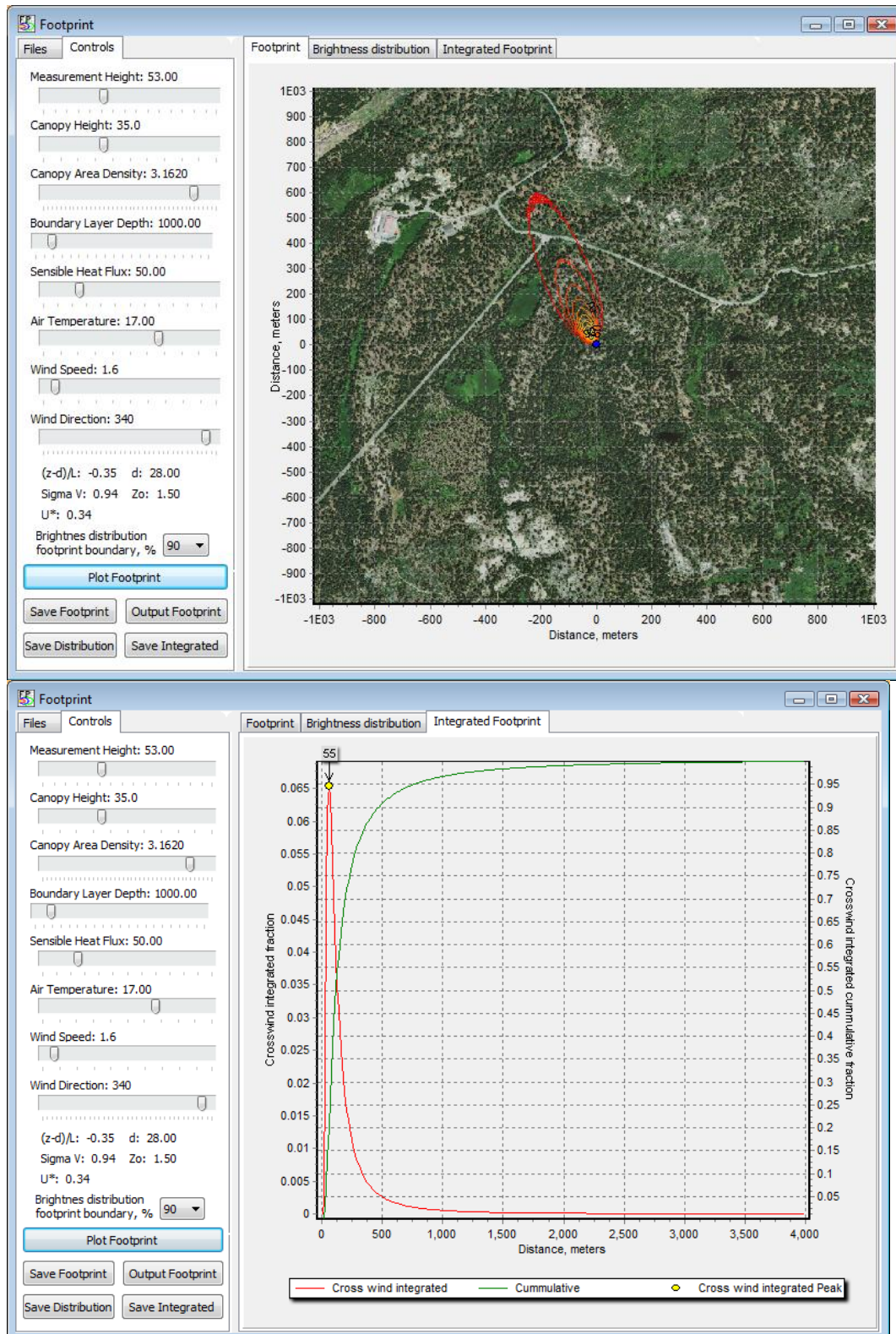

Figure 60. Lower Teakettle Relocatable site winter nighttime (stable) footprint output with mean wind speed

Title: D17 FIU Site Characterization: Supporting Data	Author: Luo/ Ayres/Loescher	Date: 09/26/2011
NEON Doc. #: NEON.DOC.011077		Revision: B

5.5 Site design and tower attributes

According to wind roses, prevailing wind blows from south and southwest (140° to 260°, clockwise from 140°, major airshed) and from northwest (290° to 350°, clockwise from 290°). The weather data used to generate the following wind roses are 2007-2009 data from MesoWest weather station DINKEY station (ID: DKYC1, Lat: 37.0664, Long: -119.0394), which is 4.5 miles away from Lower Teakettle Relocatable site. This is the closest weather station that has available wind data we can use. Due to the complex mountain topography and terrain, it is possible that the wind patterns at NEON site are actually different with the wind roses here. Wind patterns need to be reassessed within > 1 year after measurements are established, and adjust boom orientation if necessary. For the current design, **tower** should be placed to a location, to best capture the signals from the airshed of the ecosystem in interest, which is pine dominant conifer forest at this site. Original site 36.975178°, -119.048428° was too far away from power. After FIU site characterization, we micrositied tower location toward northeast for ~ 3.2 miles. The new tower location is 37.00583, -119.00602.

Eddy covariance, sonic wind and air temperature **boom arms** orientation toward the west will be best to capture signals from all major wind directions. **Radiation boom arms** should always be facing south to avoid any shadowing effects from the tower structure. An **instrument hut** should be outside the prevailing wind airshed to avoid disturbance in the measurements of wind and should be positioned to have the longer side parallel to frequent wind direction to minimize the wind effects on instrument huts and to minimize the disturbances of wind regime by instrument hut, and in this case, instrument hut should be positioned on the northeast toward tower and have the longer side parallel to SW-NE direction. Therefore, we decide the placement of instrument hut at 37.00596, -119.00590. The distance between the tower and the instrument hut is ~ 18 m.

The ecosystem around tower and in the tower airshed is mixed conifer forest. Mean canopy height is ~ 35 m. Some individual trees are emergent with >50 m in height, and 2 other lower co-dominant canopies range from 25 – 37 m. The canopy is extreme rough and ~ 25-30% open with the understory being dominated by numerous cohorts of establishing different species. Understory is mainly formed by young trees with 3 layers at 3 m, 7 m and 13 m. Vegetation on forest floor is short (~0.2 m) and sparse. There are few large stumps that were harvested decades ago. There is also a very large coarse wood debris pool, primarily old stems and new (small) branch falls. Therefore, we require 7 **measurement layers** on the tower with top measurement height at 59 m, and remaining levels are at 50 m, 35 m, 25 m, 13 m, 3 m, and 0.3 m, respectively, to best characterize the fluxes on the tower top and environmental conditions in profile.

Secondary **precipitation collector** for bulk precipitation collection will be located the top of tower at this site. No **wet deposition collector** will be deployed at this site. See AD 04 for further information and requirements for bulk precipitation collection and wet deposition collection.

The site layout is summarized in the table below. Assume the projected area of the tower is square. **Anemometer/temperature boom arm direction** is *from* the tower *toward* the prevailing wind direction or designated orientation. **Instrument hut orientation vector** is parallel to the long side of the instrument hut. **Instrument hut distance z** is the distance from the center of tower projection to the center of the instrument hut projection on the ground. The numbering of the **measurement levels** is that the lowest is level one, and each subsequent increase in height is numbered sequentially.

Title: D17 FIU Site Characterization: Supporting Data	Author: Luo/ Ayres/Loescher	Date: 09/26/2011
NEON Doc. #: NEON.DOC.011077		Revision: B

Table 20. Site design and tower attributes for Lower Teakettle Relocatable site

0° is true north with declination accounted for. Color of Instrument hut exterior shall be tan or best match the surrounding environment.

Attribute	lat	long	degree	meters	notes
Airshed			140° to 260° (major) and 290° to 350° (secondary)		Clockwise from first angle
Tower location	37.00583,	-119.00602	--	--	New site
Instrument hut	37.00596,	-119.00590			
Instrument hut orientation vector	--	--	195°-15°		longwise
Instrument hut distance z	--	--	--	18	
Anemometer/Temperature boom orientation	--	--	270°	--	
Height of the measurement levels*					
Level 1				0.3	m.a.g.l.
Level 2				3.0	m.a.g.l.
Level 3				13.0	m.a.g.l.
Level 4				25.0	m.a.g.l.
Level 5				35.0	m.a.g.l.
Level 6				50.0	m.a.g.l.
Level 7				59.0	m.a.g.l.
Tower Height				59.0	m.a.g.l.

See AD 03 for technical requirement to determine the boom height for the bottom most measurement level.

Figure below shows the proposed tower location, instrument hut location, airshed area and access road.

Title: D17 FIU Site Characterization: Supporting Data	Author: Luo/ Ayres/Loescher	Date: 09/26/2011
NEON Doc. #: NEON.DOC.011077		Revision: B

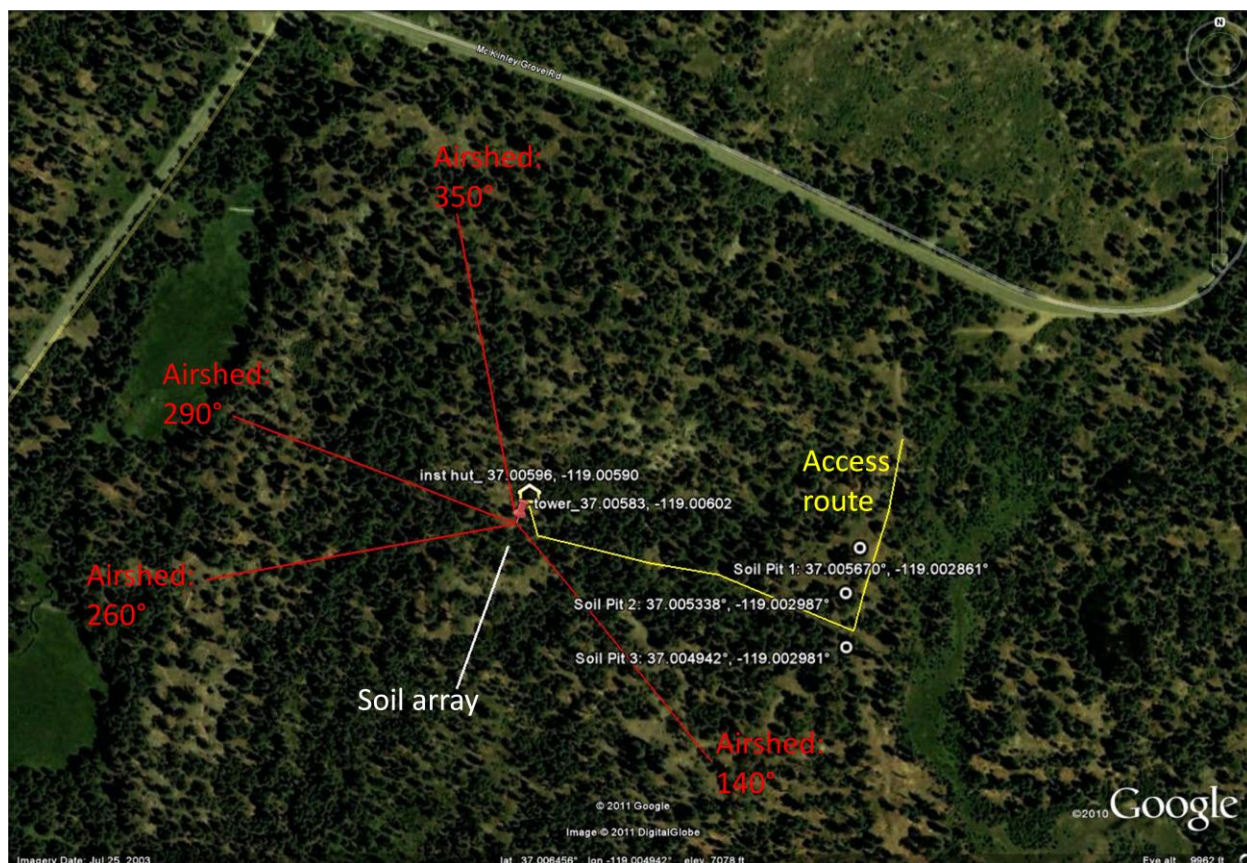

Figure 61. Site layout for Lower Teakettle Relocatable site.

i) Tower location is presented (red pin), ii) red lines indicate the airshed boundaries. Vectors 140° to 260° (major airshed, clockwise from 140°) and 290° to 350° (secondary airshed, clockwise from 290°) would have quality wind data without causing flow distortions, respectively. iii) Yellow line is the suggested access road to instrument hut.

Boardwalks. Ultimately, the decision to use a boardwalk will be, in part, based on owner’s preferences. There are strong science requirements that minimize site disturbance to the surrounding area, which will be difficult to manage over a 30-y period. Traffic control is key to minimizing the site disturbance. Confining foot traffic to boardwalks minimizes site impact; this is particularly true in places where wear caused by foot traffic becomes noticeable and grows. For example, in places with snow part of the year, worn footpaths tend to have low places that collect water, or places where the snow pack becomes uneven causing personnel to walk farther and farther around the sides of the original path, causing the path to grow in width. This is a very common phenomenon. FIU assumes that all conduits will be either buried, or placed inside the boardwalk such that it does not extend beyond the 36’ wide footprint. While the final design is not yet known, there are some general criteria that can be outlined. We assume that the boardwalk width is 36” (0.914 m). Material is not known, but must be fire proof, and in some locations the site is seasonally flooded and inundated with water. Boardwalks may also provide a scratching structure for grazing animals that in turn, would wear and unduly impact the site. Site by site evaluations must be done.

Specific boardwalks at this site:

Title: D17 FIU Site Characterization: Supporting Data	Author: Luo/ Ayres/Loescher	Date: 09/26/2011
NEON Doc. #: NEON.DOC.011077		Revision: B

- Marked path (no boardwalk or gravel) from the access point to instrument hut for security reasons. Markers should be high enough to avoid being covered by snow, which can be >2 m deep during winter.
- Boardwalk from the instrument hut to the tower to intersect on north face of the tower, pending landowner decision
- Boardwalk to soil array
- No boardwalk from soil array boardwalk to individual soil plots.

The relative locations between tower, instrument hut and boardwalk can be found in the diagram below:

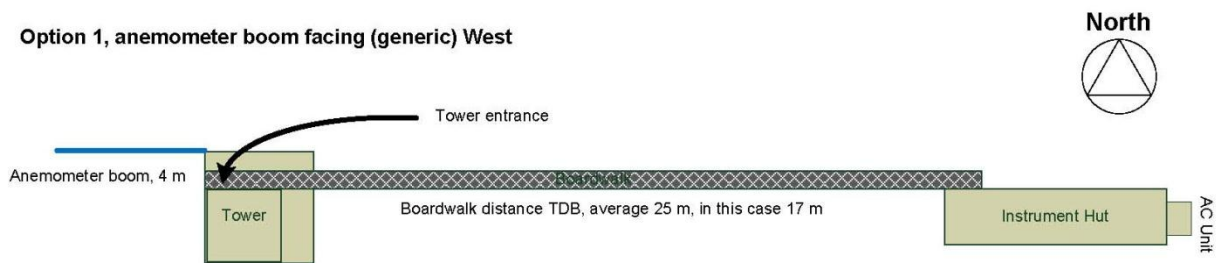

Figure 62. Generic diagram to demonstration the relationship between tower and instrument hut when boom facing west and instrument hut on the east towards the tower.

This is just a generic diagram when boom facing west and instrument hut on the eastern side of the tower. The actual design of boardwalk (or path if no boardwalk required) and instrument hut position will be joint responsibility of FCC and FIU. At Lower Teakettle Relocatable site, the boom angle will be 270 degrees, instrument hut will be on the northeast towards the tower, the distance between instrument hut and tower is ~18 m. The instrument hut vector will be SW-NE (195°-15°, longwise).

5.6 Information for ecosystem productivity plots

The tower should be positioned to optimize the collection of the air/wind signals both temporally and spatially over the desired ecosystem (mixed conifer forest). According to wind roses, prevailing wind blows from south and southwest (140° to 260°, clockwise from 140°, major airshed) and from northwest (290° to 350°, clockwise from 290°). 90% signals for flux measurements are within a distance of 500 m from tower, and 80% within 300 m with mean wind speed, but can reach ~1000 m and 500 m, respectively, at maximum wind speed. We suggest FSU EP plots are placed within the boundary of the major tower airshed (140° to 260°, clockwise from 140°).

5.7 Issues and attentions

It appears that this forest has frequent disturbance (branch falls, tree falls, frost kill, etc.). Risk of tree fall exists at this site, but is low.

The weather data used to generate the following wind roses are 2007-2009 data from MesoWest weather station DINKEY station (ID: DKYC1, Lat: 37.0664, Long: -119.0394), which is 4.5 miles away from Lower Teakettle Relocatable site. This is the closest weather station that has available wind data we can use. Due to the complex mountain topography and terrain, it is possible that the wind patterns at NEON

<i>Title:</i> D17 FIU Site Characterization: Supporting Data	<i>Author:</i> Luo/ Ayres/Loescher	<i>Date:</i> 09/26/2011
<i>NEON Doc. #:</i> NEON.DOC.011077		<i>Revision:</i> B

site are actually different with the wind roses here. Wind patterns need to be reassessed within > 1 year after measurements are established, and adjust boom orientation if necessary.

The site is surrounded by roads on 2 adjacent sides (north and west), approximate 500 m away in either direction. Winter access is good and convenient. This site also has camping ground nearby, and may be frequently used by hunters. Good security of instrument hut may be required.

Power is approximate 600 m away.

Title: D17 FIU Site Characterization: Supporting Data	Author: Luo/ Ayres/Loescher	Date: 09/26/2011
NEON Doc. #: NEON.DOC.011077		Revision: B

6 REFERENCES:

- Bond-Lamberty B., Brown K.M., Goranson C. & Gower S.T. (2006). Spatial dynamics of soil moisture and temperature in a black spruce boreal chronosequence. *Canadian Journal of Forest Research-Revue Canadienne De Recherche Forestiere*, 36, 2794-2802
- Ehleringer et al (1992). Red Butte Canyon Research Natural Area: History, Flora, Geology, Climate, and Ecology. *Great Basin Naturalist*, 2,95-121.
- Goovaerts P. (1997). *Geostatistics for Natural Resource Evaluation*. Oxford University Press, Oxford.
- Horst, TW, Weil, JC, 1992. Footprint estimation for scalar flux measurements in the atmospheric surface layer. *Boundary Layer Meteorology* **59**, 279-296.
- Horst, TW, Weil, JC, 1994a. How far is far enough?: The fetch requirements for micrometeorological measurement of surface fluxes. *J. Atmospheric Oceanic Technology*, **11**, 1019-1025.
- Horst, TW, Weil, JC, 1994b. Corrigenda: How far is far enough?: The fetch requirements for micrometeorological measurement of surface fluxes. *J. Atmospheric Oceanic Technology*, **12**, 447.
- Horst, TW, 2001. Comments on: Footprint analysis: a closed analytical solution based on height-dependent profiles of wind speed and eddy viscosity. *Boundary Layer Meteorology* **101**, 435-447.
- Kormann R, Meixner, FX, 2001. An analytic footprint model for neutral stratification, *Bound.-Layer Meteorol.* **99**.
- Riberiro J.R. & Diggle P.J. (2001). geoR: A package for geostastical analysis. R-NEWS, 1, ISSN 1609-3631
- Trangmar B.B., Yost R.S. & Uehara G. (1986). Application of geostatistics to spatial studies of soil properties. *Advances in Agronomy*, 45-94
- Webster R. & Oliver M.A. (1989). Optimal interpolation and isarithmic mapping of soil properties: VI Disjunctive kriging and mapping the conditional probability. *Journal of Soil Science*, 40, 497-512